

Panasonic

Operating Instructions
(Household) AC/Rechargeable Beard/Hair Trimmer
Model No. ER2031/2051

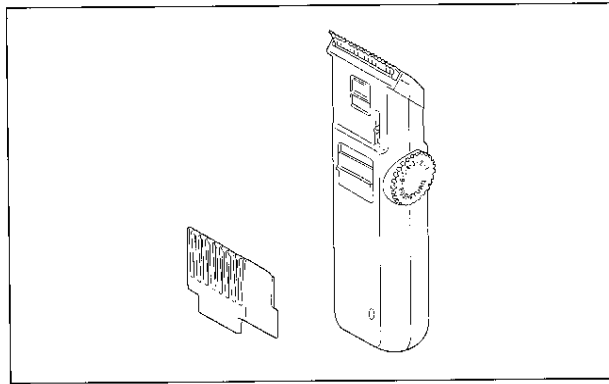

English

2

Before operating this unit, please read these instructions completely and save them for future use.

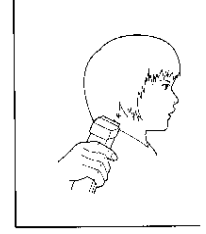
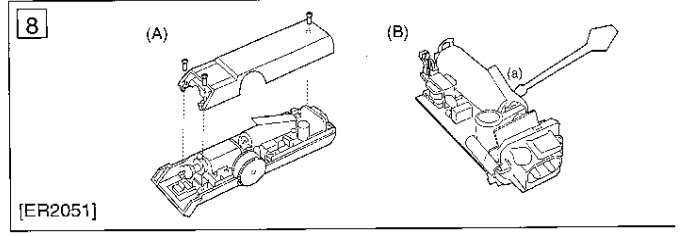
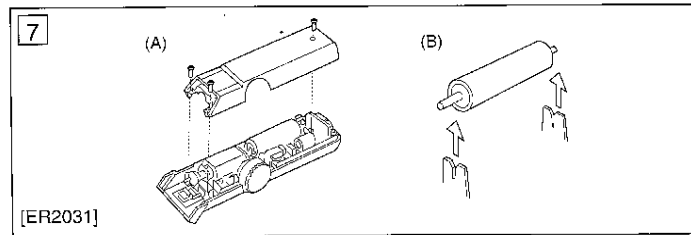
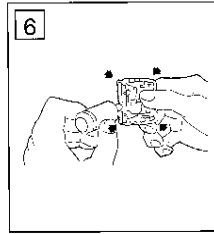
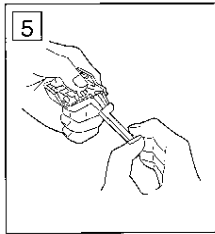
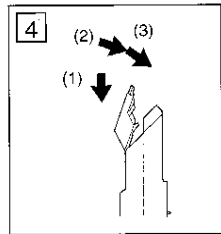
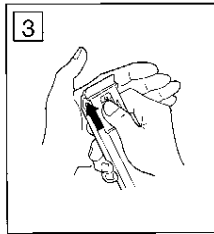
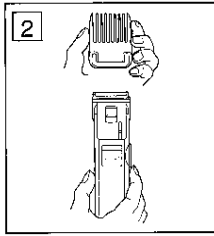
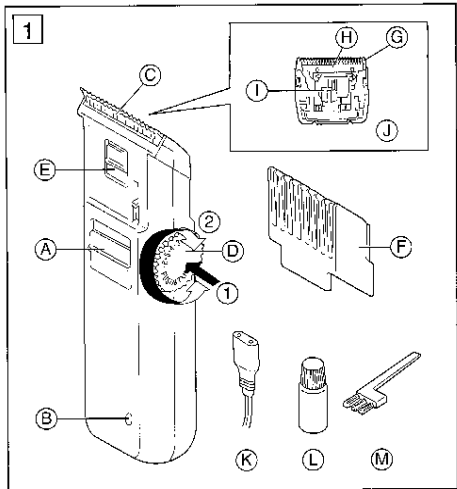

Before use

WARNING: Keep the trimmer dry.

This Beard/Hair Trimmer is for the trimming and care of mustaches and beards.

Trimming length can be adjusted between 2 to 18 mm.

The Trimmer can be operated either from an AC power source or on its rechargeable battery.

When charging the Trimmer for the first time or when it has not been in use for more than 6 months, charge it for at least 16 hours before use (ER2051 needs 8 hours).

Parts Identification (See Fig. 1)

(A) Switch

Slide up to turn on, Slide down to turn off.

(B) Charge Indicator Lamp

Lights when the unit is connected with the cord (K) to an AC power source for charging.

(The lamp flashes when recharging is completed. [ER2051])

(C) Main Blade

A precision 39 mm-wide blade which can be used with the comb attachment (F).

(D) Dial

First push, then turn the dial to a higher setting to raise the comb attachment (F) to the desired length (between 2 and 18 mm). Even if the attachment is released, the trimming length you set is retained.

(E) Blade Release Button

Slide up to release the main blade.

(F) Comb Attachment

Use this to control trimming length. (See Fig. 2)

(G) Stationary Blade

(H) Movable Blade

(I) Cleaning Lever

Push on this lever to remove bits of hair caught between the stationary blade (G) and the movable blade (H).

(J) Blade Block

Release them to remove blade block from the housing to clean or replace the blade.

(See Fig. 3, 4, 5)

(K) Power Cord

Use this to plug the Trimmer into an AC power source for recharging or for AC operation.

(L) Oil

Lubricate the spaces between the stationary (G) and movable blade (H) with a few drops of oil after use. (See Fig. 6)

(M) Cleaning Brush

Trimming Length Indicator

Indicator	Beard Length
1	2.0 mm
•	3.0 mm
2	4.5 mm
•	6.0 mm
3	7.5 mm
•	9.0 mm
4	10.5 mm
•	12.0 mm
5	13.5 mm
•	15.0 mm
6	16.5 mm
•	18.0 mm

Operation

Using the rechargeable battery

Charge the battery by plugging the Trimmer into an AC source using the cord (K).

The switch (A) should be set to "0-charge" during charging.

The Trimmer can be used for about 40 minutes after an 8-hour charge. [ER2031]

The Trimmer can be used for about 40 minutes after a 1-hour charge. [ER2051]

Using an AC power source

Plug the Trimmer into an AC power source using the cord (K) with the switch (A) set to "0-charge." Wait about 10 seconds, then turn the switch (A) on.

After use, return the switch to the "0-charge" position.

Maintenance

Care of the blades

- Hold the body of the Trimmer, slide up the main blade release button (E), squeeze both edges of the blade block to remove. (See Fig. 3)
- Brush the blade block clean and push on the cleaning lever (I) to remove bits of hair caught between the blades. (See Fig. 5)
- Lubricate the places indicated in Fig. 6 with a few drops of oil.
- Reassemble as shown in Fig. 4. First place the blade block to the correct position (1), then push until it snaps in place. (2) (3) (See Fig. 4)

Blade Life

Blade life will vary according to the frequency and length of use. For example, using the unit for 10 minutes every 3 days, the life expectancy is approximately 3 years. If cutting efficiency is reduced substantially despite proper maintenance, the blades have exceeded their service life and should be changed.

Battery life

Battery life will vary according to the frequency and length of use. If the battery is charged 3 times a

month, the service life will be approximately 6 years. If the unit is left without being charged for more than 6 months, the charge will drain from the battery and its service life may be shortened.

Therefore, even when not in regular use, it is recommended that the unit be recharged at least every six months.

[ER2031]

Nickel-Cadmium battery is contained. When you are no longer able to use your trimmer after consulting dealers and decide to discard it, make sure that the battery is disposed of at an officially assigned location, if there is one in your country.

[ER2051]

Nickel-Metal Hydride battery is contained.

When you are no longer able to use your trimmer after consulting dealers and decide to discard it, make sure that the battery is disposed of at an officially assigned location, if there is one in your country.

How to remove the built-in rechargeable battery before disposal of the trimmer (See Fig. 7, 8)

The battery in this trimmer is not intended to be replaced by consumer. However, the battery may be replaced at an authorized service center.

The procedure described below is intended only for removal of the rechargeable battery for the purpose of proper disposal.

Always make sure that the battery has been removed from the trimmer before disposing of it.

[ER2031]

1. Disconnect the power cord from AC outlet, and remove the power cord (K) from the trimmer.
2. Remove the comb attachment (f

MEMO

- and the blade block.
- Remove 3 screws and open the housing. (See Fig. 7A)
 - Remove the battery from the chassis. (See Fig. 7B)

[ER2051]

- Disconnect the power cord from the AC outlet, and remove the power cord (K) from the trimmer.
- Remove the blade from the trimmer.
- Remove 3 screws and open the housing. (See Fig. 8)
- Remove the circuit block from the housing. Raise the battery and insert the screwdriver into (a) to remove the terminal. Remove the terminal from the other side in the same manner.
- Remove the battery.

Attention

- Do not charge the trimmer at temperatures below 5 °C (41 °F) or above 35 °C (95 °F), or where it will be exposed to direct sunlight, or other heat sources.
- Clean the housing only with a soft cloth slightly dampened with water or soapy water. Never use a caustic cleaner such as benzine or bleach.
- The trimmer may become warm during operation and normal recharging. This is normal.

Caution

- This appliance is not intended for use by persons (including children) with reduced physical, sensory or mental capabilities, or lack of experience and knowledge, unless they have been given supervision or instruction concerning use of the appliance by a person responsible for their safety. Children should be supervised to ensure that they do not play with the appliance.

- Never tamper with the moving parts.
- Do not pick up the trimmer by the cord. It may become detached, causing damage or injury.
- Do not use on animals.
- Never disassemble the trimmer. Take it to a qualified service person when service or repair is required.
- Do not attempt to use any power cord other than one specifically designed for this model. Use only the included power cord.
- Do not pull, twist or severely bend the power cord.
- Do not wrap the power cord tightly around the appliance.
- Keep the Trimmer and power cord away from water and handle it only with dry hands.
- Store the Trimmer and power cord in a dry area where it will be protected from damage.
- Never immerse the Trimmer in water.
- The supply cord cannot be replaced. If the cord is damaged, the appliance should be scrapped. This product is intended for household use only.

Specifications

Power source: See the name plate on the product.

Motor voltage: 1.2 V

Charging time: 8 hours [ER2031]
1 hour [ER2051]