

Panasonic®

Operating Instructions (Household) Rechargeable Shaver

Model No. ES-LF51



Panasonic Electric Works Co., Ltd.

<http://panasonic.net>

Before operating this unit, please read these instructions completely and save them for future use.

Ⓕ EN

Printed in Japan
ES9700LF511H Y0611-0

Thank you for choosing a Panasonic shaver ES-LF51. With our WET/DRY technology, you can enjoy using your Panasonic shaver dry or in the shower or bath for gentle and easy shaving. Please read all instructions before use.

Important

This shaver has a built-in rechargeable battery. Do not throw into fire, apply heat, or charge, use, or leave in a high temperature environment.

► Before use

This WET/DRY shaver can be used for wet shaving using shaving lather or for dry shaving. You can use this shaver in the shower and clean with water. The following symbol means suitable for use in a bath or shower.



Treat yourself to wet lather shaves for at least three weeks and notice the difference. Your Panasonic WET/DRY shaver requires a little time to get used to because your skin and beard need about a month to adjust to any new shaving method.

► Using the shaver

Caution

The outer foil is very thin and can be damaged if not used correctly. Check that the foil is not damaged before using the shaver. Do not use the shaver if the foil is damaged as you will cut your skin.

- Do not use the shaver if there is an abnormality or failure.
- Do not share your shaver with your family or other people. Doing so may result in infection or inflammation.

- This appliance is not intended for use by persons (including children) with reduced physical, sensory or mental capabilities, or lack of experience and knowledge, unless they have been given supervision or instruction concerning use of the appliance by a person responsible for their safety. Children should be supervised to ensure that they do not play with the appliance.

► Charging the shaver

- Never use the AC adaptor in the bathroom or shower room.
- Do not use any power cord or AC adaptor other than the AC adaptor (RE7-59).
- Plug in the AC adaptor into a household outlet where there is no moisture and handle it with dry hands.
- Hold the AC adaptor when disconnecting it from the household outlet. If you tug on the power cord, you may damage it.
- The supply cord cannot be replaced. If the cord is damaged, the AC adaptor should be scrapped.

► Cleaning the shaver

Warning

Disconnect the power cord from the shaver before cleaning it in water to prevent electric shock.

- Keep both the inner blades inserted. If only one of the inner blades is inserted, the shaver may be damaged.
- If you clean the shaver with water, do not use salt water or hot water. Do not soak the shaver in water for a long period of time.
- Clean the housing only with a soft cloth slightly dampened with tap water or soapy tap water. Do not use thinner, benzine, alcohol or other chemicals.

► Storing the shaver

- Store the shaver in a place with low humidity after use.
- Do not store the shaver where it will be exposed to direct sunlight or other heat sources.
- Disconnect the power cord when storing the shaver.

- Do not bend the power cord or wrap it around the shaver.
- Keep the oil away from children.

Parts identification

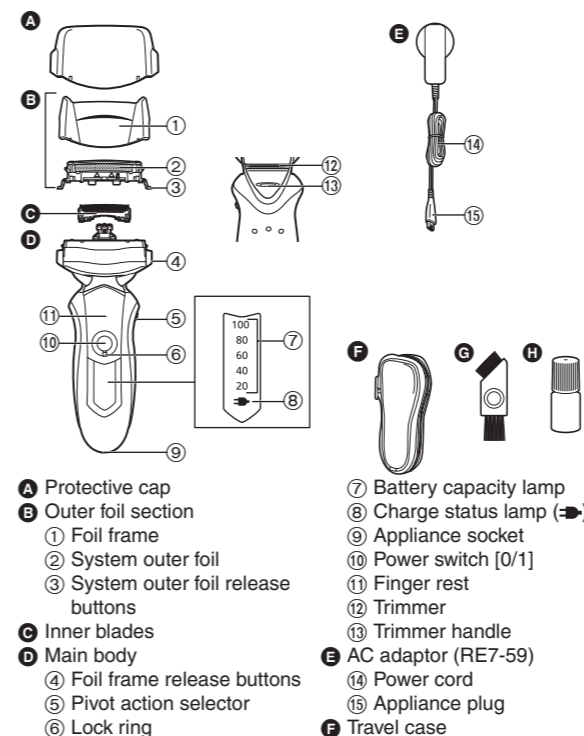

- G** Cleaning brush
- H** Oil

Using the lock ring

Use the lock ring to lock or unlock the power switch. Rotate the lock ring until it clicks.



Rotate the lock ring to "O" to unlock the power switch:
For when shaving, washing the shaver, lubricating the shaver.



Rotate the lock ring to "L" to lock the power switch:
For when carrying the shaver.

Charge

Charging the shaver

- 1** Insert the appliance plug into the shaver.
- 2** Plug in the AC adaptor into a household outlet.

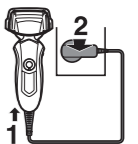

- Turn the shaver off before attaching.
- Charging is completed after approx. 1 hour.

You cannot operate the shaver while charging.

Reading lamps when charging

While charging

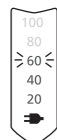

The charge status lamp (➔) glows. The number of the battery capacity lamp will increase as charging progresses.

After charging is completed

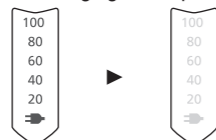

All the lamps will light up and then turn off after 5 seconds.

- After charging is completed, turning the power switch ON with the shaver plugged in will cause all the lamps to light up and then turn off after 5 seconds. This shows that the shaver is fully charged.
- Recommended ambient temperature for charging is 5-35 °C. The battery may not charge properly or at all under extreme low or high temperatures. The charge status lamp (➔) will blink when there is a problem with charging.
- When charging the shaver for the first time or when it has not been in use for more than 6 months, the charge status lamp (➔) may not glow. It will eventually glow if kept connected.

Shave

Using the shaver



- 1 Rotate the lock ring to unlock the power switch and press the power switch.
- 2 Hold the shaver as illustrated above and shave.

Page 3

- We recommend using the shaver in an ambient temperature range of 5 - 35 °C. If used outside this range, the appliance may stop operating.

Start out shaving by applying gentle pressure to your face. Stretch your skin with your free hand and move the shaver back and forth in the direction of your beard. You may gently increase the amount of pressure as your skin becomes accustomed to this shaver. Applying excessive pressure does not provide a closer shave.

Caution

- If you press the power switch for more than 2 seconds, the sonic vibration cleaning mode is activated. **Page 5**
- Do not place your fingers on the power switch while using the shaver. This may cause the shaver to turn off or enter the sonic vibration cleaning mode. Place your fingers on the finger rest while using the shaver.

4

Pivot action selector

Use to select "SOFT" (soft) or "LOCK" (lock). You can change the pivot action whether the shaver is turned on or off.

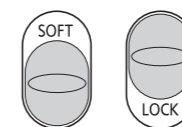

Using the trimmer

Slide the trimmer handle up. Place at a right angle to your skin and move downwards to trim your sideburns.



Reading lamps when using

While using

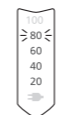

• Approximate amount of battery charge is displayed as 20 - 100.

- It will turn off approximately 5 seconds after operating the switch.

When the battery capacity is low



"20" blinks when operating the shaver.

- You can shave 2 to 3 times after "20" appears. (This will differ depending on usage.)
- A full charge will supply enough power for approx. 14 shaves of 3 minutes each. (This will differ depending on usage.)

5

Clean

Cleaning the shaver

1. Disconnect the power cord from the shaver.
2. Apply some hand soap and some water to the outer foil.
3. Rotate the lock ring to unlock the power switch.
4. Press the power switch for more than 2 seconds to activate the sonic vibration cleaning mode.
 - The battery capacity lamps blink in order.
 - After about 20 seconds, it will be automatically turned off, or you can turn it off by pressing the power switch.
5. Remove the outer foil section and press the power switch for more than 2 seconds to activate the sonic vibration cleaning mode and clean it with running water.
6. Wipe off any drops of water with a dry cloth.
7. Dry the outer foil section and the shaver completely.
8. Attach the outer foil section to the shaver.
9. Lubricate the shaver.

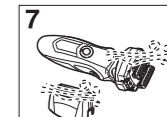
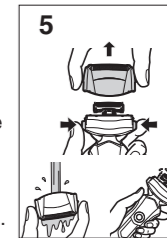
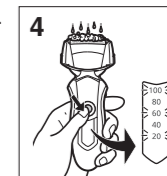

Lubrication

To maintain shaving comfort for a long time, it is recommended that the oil provided with the shaver is used.

1. Switch off the shaver.
2. Apply one drop of oil to each of the outer foils.
3. Raise the trimmer and apply a drop of oil.
4. Switch the shaver on, and run it for approximately five seconds.
5. Switch off the shaver, and wipe off any excess oil from the outer foils with a soft cloth.

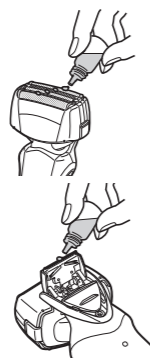

Cleaning with the brush

Clean the inner blades using the short brush by moving it in direction (A).

Clean the system outer foil, the shaver body and the trimmer using the long brush.

- Do not move the short brush in direction (B) as it will damage the inner blades and affect their sharpness.
- Do not use the short brush to clean the outer foils.

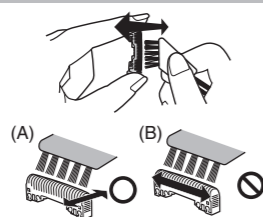

6

Replacing the system outer foil and the inner blades

system outer foil	once every year
inner blades	once every two years

Replacing the system outer foil

1. Press the foil frame release buttons and lift the outer foil section upwards.
2. Press the system outer foil release buttons and pull down the system outer foil.
3. Align the foil frame mark (L) and the system outer foil mark (Δ) and securely attach together.
 - The system outer foil cannot be reversely attached.
 - Always insert the system outer foil to the foil frame when attaching to the shaver.
4. After turning the foil frame mark (L) to the front, securely attach the outer foil section to the shaver until it clicks.

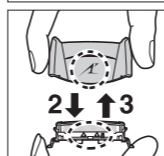

Replacing the inner blades

1. Press the foil frame release buttons and lift the outer foil section upwards.
2. Remove the inner blades one at a time.
 - Do not touch the edges (metal parts) of the inner blades to prevent injury to your hand.
3. Insert the inner blades one at a time until they click.

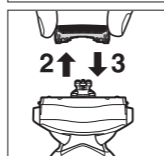
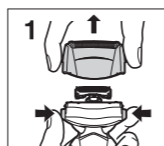

Replacement parts

Replacement parts are available at your dealer or Service Center.

Replacement parts for ES-LF51	System outer foil and inner blades	WES9027
	System outer foil	WES9167
	Inner blades	WES9068

Removing the built-in rechargeable battery

Remove the built-in rechargeable battery before disposing of the shaver. Please make sure that the battery is disposed of at an officially designated location if there is one. Do not dismantle or replace the battery so that you can use the shaver again. This could cause fire or an electric shock. Please contact an authorised service center.

- Disconnect the power cord from the shaver when removing the battery.

- Perform steps ① to ⑨ and lift the battery, and then remove it.

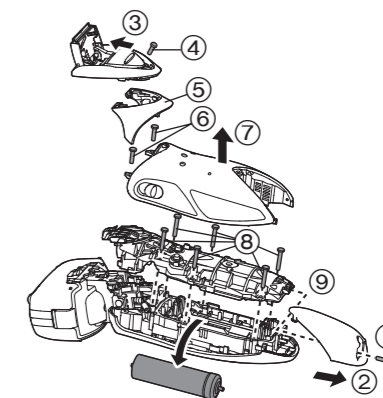

For environmental protection and recycling of materials

This shaver contains a Lithium-ion battery. Please make sure that the battery is disposed of at an officially assigned location, if there is one in your country.

Specifications

Power source	See the name plate on the AC adaptor. (Automatic voltage conversion)
Motor voltage	3.6 V==
Charging time	Approx. 1 hour

This product is intended for household use only.

7