

Panasonic®

Operating Instructions High Definition Video Camera

Model No. **HDC-SD700**
HDC-TM700
HDC-HS700

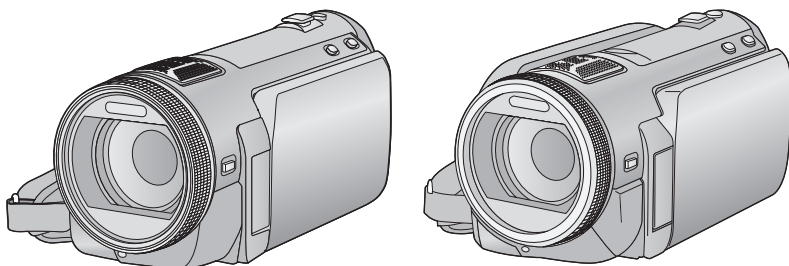

Before use, please read these instructions completely.

Please also refer to Operating Instructions (PDF format) recorded on the CD-ROM containing the Operating Instructions (supplied).

You can learn about advanced operation methods and check the Troubleshooting.



AVCHD™

DOLBY
DIGITAL
5.1 CREATOR

LEICA
DICOMAR

SD™
XC

HDMI

VIERA
Link

Information for Your Safety

WARNING:

TO REDUCE THE RISK OF FIRE, ELECTRIC SHOCK OR PRODUCT DAMAGE,

- **DO NOT EXPOSE THIS APPARATUS TO RAIN, MOISTURE, DRIPPING OR SPLASHING AND THAT NO OBJECTS FILLED WITH LIQUIDS, SUCH AS VASES, SHALL BE PLACED ON THE APPARATUS.**
- **USE ONLY THE RECOMMENDED ACCESSORIES.**
- **DO NOT REMOVE THE COVER (OR BACK); THERE ARE NO USER SERVICEABLE PARTS INSIDE. REFER SERVICING TO QUALIFIED SERVICE PERSONNEL.**

CAUTION!

- **DO NOT INSTALL OR PLACE THIS UNIT IN A BOOKCASE, BUILT-IN CABINET OR IN ANOTHER CONFINED SPACE. ENSURE THE UNIT IS WELL VENTILATED. TO PREVENT RISK OF ELECTRIC SHOCK OR FIRE HAZARD DUE TO OVERHEATING, ENSURE THAT CURTAINS AND ANY OTHER MATERIALS DO NOT OBSTRUCT THE VENTILATION VENTS.**
- **DO NOT OBSTRUCT THE UNIT'S VENTILATION OPENINGS WITH NEWSPAPERS, TABLECLOTHS, CURTAINS, AND SIMILAR ITEMS.**
- **DO NOT PLACE SOURCES OF NAKED FLAMES, SUCH AS LIGHTED CANDLES, ON THE UNIT.**
- **DISPOSE OF BATTERIES IN AN ENVIRONMENTALLY FRIENDLY MANNER.**

The socket outlet shall be installed near the equipment and easily accessible. The mains plug of the power supply cord shall remain readily operable. To completely disconnect this apparatus from the AC Mains, disconnect the power supply cord plug from AC receptacle.

■ **Concerning the battery**

Warning

Risk of fire, explosion and burns. Do not disassemble.

Do not heat the batteries above the following temperatures or incinerate.

Button-type battery **60 °C**

Battery pack **60 °C**

CAUTION

Danger of explosion if battery is incorrectly replaced. Replace only with the same or equivalent type recommended by the manufacturer. Dispose of used batteries according to the manufacturer's instructions.

Warning

Keep the Button-Type battery out of the reach of children. Never put Button-Type battery in mouth. If swallowed call your doctor.

Button-type battery: CR2025

Use only the recommended accessories.

- Do not use any other AV multi cables and USB cables except the supplied one.
- When you use the cable which are sold separately, please make sure to use the one whose length is less than 3 metres.
- Keep the Memory Card out of reach of children to prevent swallowing.

■ Concerning the AC adaptor

Product Identification Marking is located on the bottom of unit.

-If you see this symbol-

Information on Disposal in other Countries outside the European Union



This symbol is only valid in the European Union. If you wish to discard this product, please contact your local authorities or dealer and ask for the correct method of disposal.

How to replace the fuse

The location of the fuse differ according to the type of AC mains plug (figures A and B).

Confirm the AC mains plug fitted and follow the instructions below. Illustrations may differ from actual AC mains plug.

- 1) Open the fuse cover with a screwdriver.

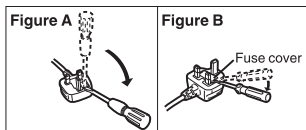

- 2) Replace the fuse and close or attach the fuse cover.

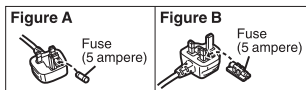

■ Cautions for use

Keep the High Definition Video Camera as far away as possible from electromagnetic equipment (such as microwave ovens, TVs, video games etc.).

- If you use the High Definition Video Camera on top of or near a TV, the pictures and sound on the High Definition Video Camera may be disrupted by electromagnetic wave radiation.
- Do not use the High Definition Video Camera near cell phones because doing so may result in noise adversely affecting the pictures and sound.
- Recorded data may be damaged, or pictures may be distorted, by strong magnetic fields created by speakers or large motors.
- Electromagnetic wave radiation generated by microprocessors may adversely affect the High Definition Video Camera, disturbing the pictures and sound.
- If the High Definition Video Camera is adversely affected by electromagnetic equipment and stops functioning properly, turn the High Definition Video Camera off and remove the battery or disconnect AC adaptor. Then reinsert the battery or reconnect AC adaptor and turn the High Definition Video Camera on.

Do not use the High Definition Video Camera near radio transmitters or high-voltage lines.

- If you record near radio transmitters or high-voltage lines, the recorded pictures and sound may be adversely affected.

About connecting to a PC

- Do not use any other USB cables except the supplied one.

■ Indemnity about recorded content

Panasonic does not accept any responsibility for damages directly or indirectly due to any type of problems that result in loss of recording or edited content, and does not guarantee any content if recording or editing does not work properly. Likewise, the above also applies in a case where any type of repair is made to the unit (including any other non-built-in memory/HDD related component).

■ Cards that you can use with this unit

SD Memory Card, SDHC Memory Card and SDXC Memory Card

- 4 GB or more Memory Cards that do not have the SDHC logo or 48 GB or more Memory Cards that do not have the SDXC logo are not based on SD Memory Card Specifications.
- Refer to page 18 for more details on SD cards.

■ For the purposes of these operating instructions

- SD Memory Card, SDHC Memory Card and SDXC Memory Card are referred to as the "SD card".
- Functions that can be used for motion picture recording/motion picture playback are indicated by **VIDEO** in these operating instructions.
- Functions that can be used for still picture recording/still picture playback are indicated by **PHOTO** in these operating instructions.

- Pages for reference are indicated by an arrow, for example: → 00

These operating instructions are designed for use with models **HDC-SD700**, **HDC-TM700** and **HDC-HS700**. Pictures may be slightly different from the original.

- The illustrations used in these operating instructions show model **HDC-SD700**, however, parts of the explanation refer to different models.
- Depending on the model, some functions are not available.
- Features may vary, so please read carefully.
- Not all models may be available depending on the region of purchase.

Contents

Information for Your Safety.....	2
Accessories.....	6

Preparation

Before using

- 1 **Parts identification and handling**..... 7
 - [HDC-SD700]/[HDC-TM700]..... 7
 - [HDC-HS700]..... 10

Setup

- 1 **Power supply**..... 13
 - Charging the battery 13
 - Inserting/removing the battery 14
 - Charging and recording time..... 15
 - Connecting to the AC outlet..... 17
- 2 **Recording to a card**..... 18
 - Cards that you can use with this unit..... 18
 - Inserting/removing an SD card 19
- 3 **Turning the unit on/off**..... 20
 - Turning the power on and off with the power button 20
 - Turning the power on and off with the LCD monitor/viewfinder..... 20
- 4 **Selecting a mode** 21
- 5 **Adjusting LCD monitor/viewfinder** 22
 - How to use the touch screen 22
 - Viewfinder adjustment..... 22
- 6 **Setting date and time**..... 23

Basic

Recording/Playback

- 1 **Selecting a media to record** [HDC-TM700/HDC-HS700] 24
- 2 **Recording motion pictures** 25
- 3 **Recording still pictures** 26
- 4 **Intelligent auto mode** 27
- 5 **Motion picture/Still picture playback** 28

Setup

- 1 **Using the menu screen** 30
 - Language selection..... 30

Advanced

Recording (Advanced)

- 1 **Zoom in/out function** 31
 - Zoom mode..... 31
 - Ring zoom..... 32
 - Extra optical zoom 32
- 2 **Optical image stabilizer function**..... 33

Editing

- 1 **Deleting scenes/still pictures**..... 34
- 2 **Formatting** 35

With a TV

- 1 **Watching Video/Pictures on your TV**..... 36

Others

- Specifications** 38
- About copyright**..... 42
- Reading the Operating Instructions (PDF format)**..... 43

Accessories

Check the accessories before using this unit.

Product numbers correct as of Feb. 2010. These may be subject to change.

Battery pack
VW-VBG130



AC adaptor
VSK0698



AC cable

- (A) K2CT39A00002
- (B) K2CQ29A00002

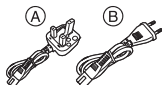

- (A) Hong Kong Special Administrative Region of China and Saudi Arabia
- (B) Areas Other than Hong Kong Special Administrative Region of China and Saudi Arabia

DC cable
K2GJYDC00004



Remote control
(Battery built-in)
N2QAEC000024



AV multi cable
K1HY12YY0004



USB cable
K1HY04YY0032



Stylus pen
VGQ0C14



Lens hood
VDW2053



Shoe adaptor
(supplied for HDC-SD700/
HDC-TM700; not supplied
for HDC-HS700)
VYC0996



CD-ROM
Software



CD-ROM
Operating Instructions
VFF0613



Optional accessories

Some optional accessories may not be available in some countries.

AC adaptor (VW-AD21E/EB-K)*1
Battery pack (lithium/VW-VBG130)
Battery pack (lithium/VW-VBG260)
Battery pack (lithium/VW-VBG6)*2
Battery pack holder kit (VW-VH04)
HDMI mini cable (RP-CDHM15, RP-CDHM30)
Wide conversion lens (VW-W4607H)
Wide end conversion lens (VW-WE08H)*3
Filter kit (VW-LF46NE)*4
Video DC light (VW-LDC103E)
Light bulb for video DC light (VZ-LL10E)
Stereo microphone (VW-VMS2E)*5
Shoe adaptor (VW-SK12E)
DVD burner (VW-BN2)

*1 The supplied DC cables cannot be used on this unit.

*2 The battery pack holder kit/VW-VH04 (optional) is necessary.

*3 When using the VW-WE08H, set the zoom to W (wide) side. The focus will be slightly out when it is set to T (tele) side, so remove the VW-WE08H when recording set to T (tele) side.

*4 When using the VW-LF46NE, remove the lens hood (supplied) and set to the flash setting to  (OFF).

*5 External microphone may intrude into the frame when recording. Set the zoom to wide angle, and tilt the external microphone upward so it will not intrude into the frame. This will not affect the audio being recorded.

1

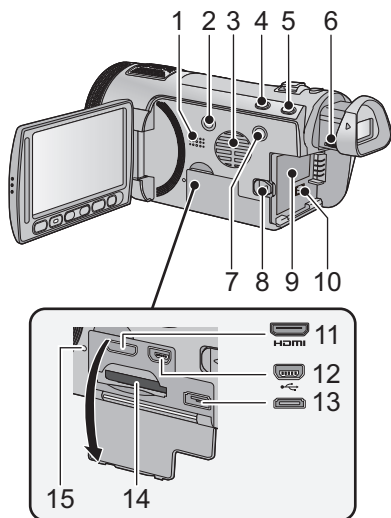

Parts identification and handling

[HDC-SD700]/[HDC-TM700]

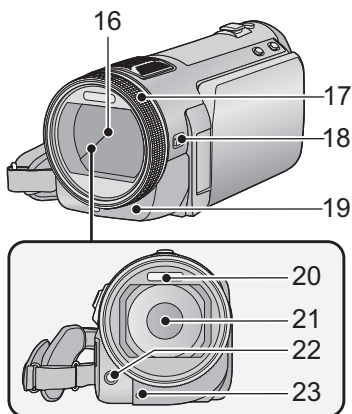

- 1 Speaker
- 2 Power button [ON/OFF] (→ 20)
- 3 Inlet (cooling fan)
- 4 Intelligent auto/Manual button [iA/MANUAL] (→ 27)
- 5 Optical image stabilizer button [O.I.S.] (→ 33)
- 6 Eyepiece corrector dial
- 7 1080/50p button [1080/50p]
- 8 Battery release lever [BATT] (→ 14)
- 9 Battery holder (→ 14)
- 10 DC input terminal [DC IN] (→ 17)
- Always use the supplied AC adaptor or a genuine Panasonic AC adaptor (VW-AD21E/EB-K; optional).
- 11 HDMI mini connector [HDMI] (→ 36)
- 12 USB terminal [USB]
- 13 AV multi connector (→ 36)
- Use the AV multi cable (only the supplied cable).
- 14 Card slot (→ 19)
- 15 Access lamp [ACCESS] (→ 19)



- 16 Lens cover
- The lens cover opens in  motion picture recording mode or  still picture recording mode. (→ 21)
- 17 Multi manual ring
- 18 Camera function button [CAMERA FUNCTION]
- 19 Remote control sensor
- 20 Built-in flash
- 21 Lens (LEICA DICOMAR)
- 22 AF assist lamp
- 23 Recording lamp

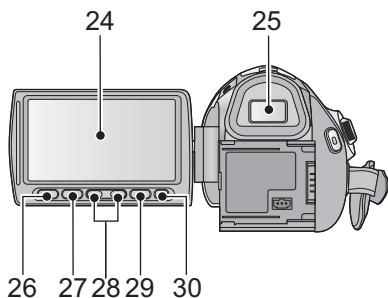

24 LCD monitor (Touch screen) (→ 22)



- It can open up to 90°.

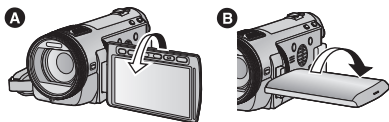

- It can rotate up to 180° **A** towards the lens or 90° **B** towards the viewfinder.

Due to limitations in LCD production technology, there may be some tiny bright or dark spots on the LCD monitor screen. However, this is not a malfunction and does not affect the recorded picture.

25 Viewfinder

Due to limitations in LCD production technology, there may be some tiny bright or dark spots on the viewfinder screen. However, this is not a malfunction and does not affect the recorded picture.

26 Quick menu button [Q.MENU]

27 Sub recording start/stop button

- This button functions in the same manner as the recording start/stop button.

28 Adjust zoom buttons (→ 31)

29 Menu button [MENU] (→ 30)

30 Delete button [] (→ 34)

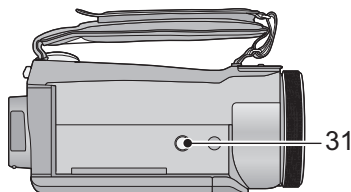

31 Tripod receptacle

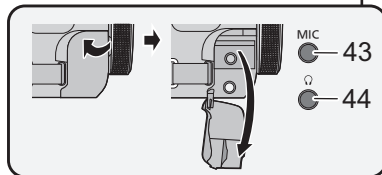
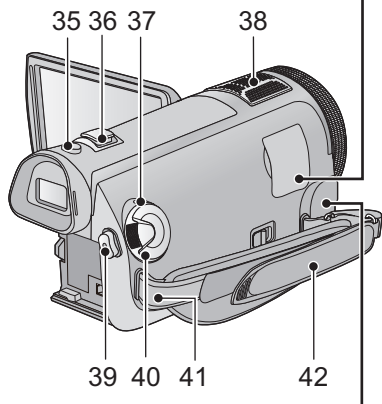
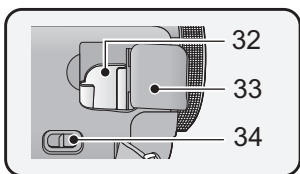

- 32 Shoe adaptor mounting part
- 33 Shoe adaptor cover
- 34 Shoe adaptor release lever
- [SHOE ADAPTOR RELEASE]
- 35 Photoshot button [] (→ 26)
- 36 Zoom lever [W/T] (In motion picture recording mode or still picture recording mode) (→ 31)
- Thumbnail display switch [/]
- Volume lever [-VOL+] (In playback mode)
- 37 Status indicator (→ 20)
- 38 Internal microphones
- 39 Recording start/stop button (→ 25)
- 40 Mode dial (→ 21)
- 41 Shoulder strap fixture
- 42 Grip belt

Adjust the length of the grip belt so that it fits your hand.

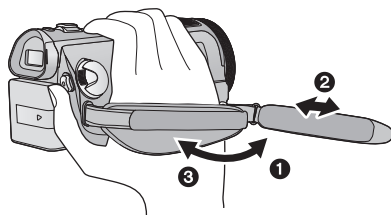

- ① Flip the belt.
- ② Adjust the length.
- ③ Replace the belt.

43 Microphone terminal [MIC]

- A compatible plug-in powered microphone can be used as an external microphone.
- Audio will be stereo (2 ch) with the external microphone input.
- When the unit is connected with the AC adaptor, sometimes noise may be heard depending on the microphone type. In this case, please switch to the battery for the power supply and the noise will stop.

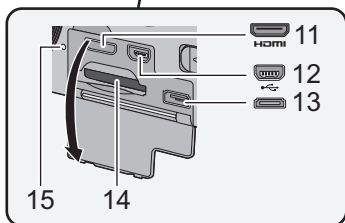
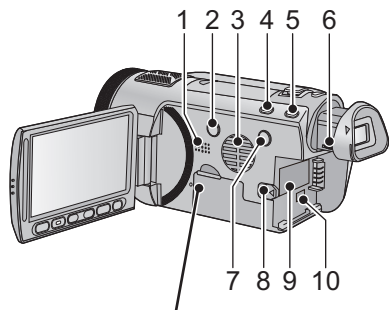

44 Headphone terminal []

- Excessive sound pressure from earphones and headphones can cause hearing loss.

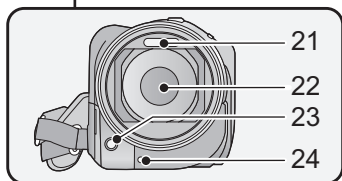
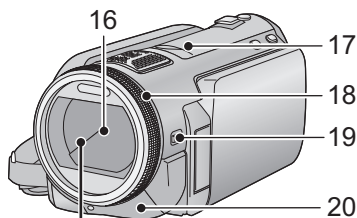

- 1 **Speaker**
 - 2 **Power button** [⏻/⏻] (→ 20)
 - 3 **Inlet (cooling fan)**
 - 4 **Intelligent auto/Manual button** [iA/MANUAL] (→ 27)
 - 5 **Optical image stabilizer button** [O.I.S.] (→ 33)
 - 6 **Eyepiece corrector dial**
 - 7 **1080/50p button** [1080/50p]
 - 8 **Battery release lever** [BATT] (→ 14)
 - 9 **Battery holder** (→ 14)
 - 10 **DC input terminal** [DC IN] (→ 17)
- Always use the supplied AC adaptor or a genuine Panasonic AC adaptor (VW-AD21E/EB-K; optional).
- 11 **HDMI mini connector** [HDMI] (→ 36)
 - 12 **USB terminal** [↔]
 - 13 **AV multi connector** (→ 36)
 - Use the AV multi cable (only the supplied cable).
 - 14 **Card slot** (→ 19)
 - 15 **Access lamp** [ACCESS] (→ 19)



- 16 **Lens cover**
- The lens cover opens in  motion picture recording mode or  still picture recording mode. (→ 21)
- 17 **Accessory shoe**
- 18 **Multi manual ring**
- 19 **Camera function button** [CAMERA FUNCTION]
- 20 **Remote control sensor**
- 21 **Built-in flash**
- 22 **Lens (LEICA DICOMAR)**
- 23 **AF assist lamp**
- 24 **Recording lamp**

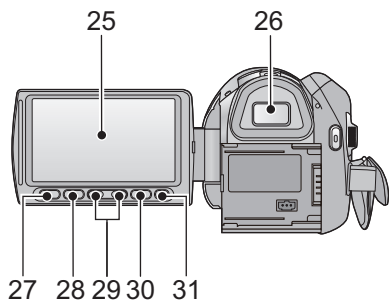

25 LCD monitor (Touch screen) (→ 22)



- It can open up to 90°.

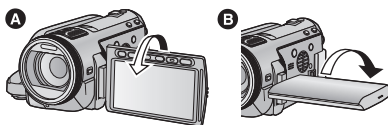

- It can rotate up to 180° **A** towards the lens or 90° **B** towards the viewfinder.

Due to limitations in LCD production technology, there may be some tiny bright or dark spots on the LCD monitor screen. However, this is not a malfunction and does not affect the recorded picture.

26 Viewfinder

Due to limitations in LCD production technology, there may be some tiny bright or dark spots on the viewfinder screen. However, this is not a malfunction and does not affect the recorded picture.

27 Quick menu button [Q.MENU]

28 Sub recording start/stop button

- This button functions in the same manner as the recording start/stop button.

29 Adjust zoom buttons (→ 31)

30 Menu button [MENU] (→ 30)

31 Delete button [] (→ 34)

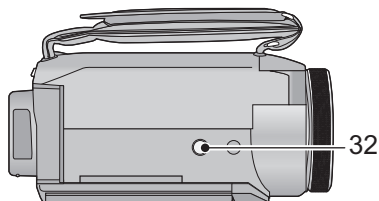

32 Tripod receptacle

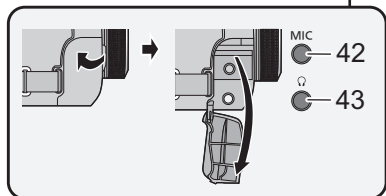
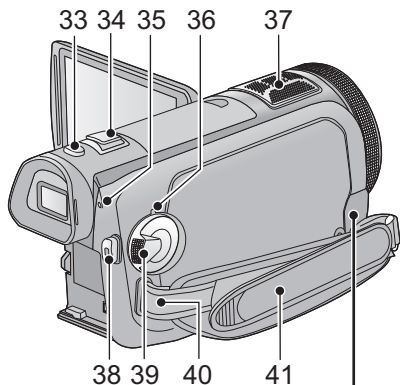

- 33 Photoshot button [] (→ 26)
- 34 Zoom lever [W/T] (In motion picture recording mode or still picture recording mode) (→ 31)
- Thumbnail display switch [/]
- Volume lever [-VOL+] (In playback mode)
- 35 HDD access lamp [ACCESS HDD]
- 36 Status indicator (→ 20)
- 37 Internal microphones
- 38 Recording start/stop button (→ 25)
- 39 Mode dial (→ 21)
- 40 Shoulder strap fixture
- 41 Grip belt

Adjust the length of the grip belt so that it fits your hand.

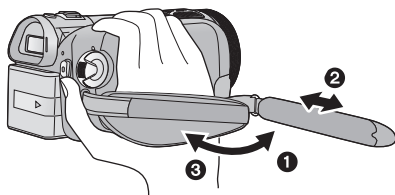

- 1 Flip the belt.
 - 2 Adjust the length.
 - 3 Replace the belt.
- 42 **Microphone terminal [MIC]**
 - A compatible plug-in powered microphone can be used as an external microphone.
 - Audio will be stereo (2 ch) with the external microphone input.
 - When the unit is connected with the AC adaptor, sometimes noise may be heard depending on the microphone type. In this case, please switch to the battery for the power supply and the noise will stop.
 - 43 **Headphone terminal []**
 - Excessive sound pressure from earphones and headphones can cause hearing loss.

Power supply

■ About batteries that you can use with this unit

The battery that can be used with this unit is VW-VBG130/VW-VBG260/VW-VBG6.

- This unit has a function to distinguish the batteries that can be used, and the batteries (VW-VBG130/VW-VBG260/VW-VBG6) are compatible with this function. (The batteries that are not compatible to this function cannot be used.)
- To use the VW-VBG6 for this unit, the battery pack holder kit VW-VH04 (optional) is required.

It has been found that counterfeit battery packs which look very similar to the genuine product are made available to purchase in some markets. Some of these battery packs are not adequately protected with internal protection to meet the requirements of appropriate safety standards. There is a possibility that these battery packs may lead to fire or explosion. Please be advised that we are not liable for any accident or failure occurring as a result of use of a counterfeit battery pack. To ensure that safe products are used we would recommend that a genuine Panasonic battery pack is used.

Charging the battery

When this unit is purchased, the battery is not charged. Charge the battery before using this unit.

Important:

If the DC cable is connected to the AC adaptor, then the battery will not charge. Remove the DC cable from the AC adaptor.

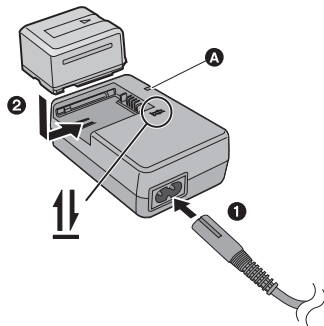

Charging lamp [CHARGE] **A**

Lights up:

Charging (Battery charging time: → 15)

Goes off:

Charging completed

Flashing:

Be sure to connect the unit correctly

- 1 Connect the AC cable to the AC adaptor and the AC outlet.
- 2 Insert the battery into the AC adaptor by aligning the arrows.

- We recommend using Panasonic batteries. (→ 6, 15, 16)
- If you use other batteries, we cannot guarantee the quality of this product.
- Do not heat or expose to flame.
- Do not leave the battery(ies) in an automobile exposed to direct sunlight for a long period of time with doors and windows closed.

Inserting/removing the battery

Install the battery by inserting it in the direction shown in the figure.

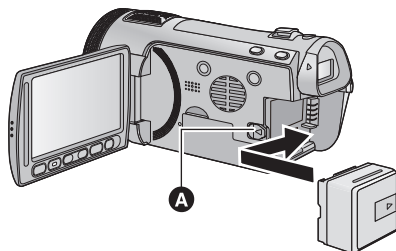

- A** Insert the battery until it clicks and locks.

Removing the battery

Be sure to hold down the power button until the status indicator goes off. Then remove the battery while supporting the unit to prevent it dropping.

Move the battery release lever in the direction indicated by the arrow and remove the battery when unlocked.

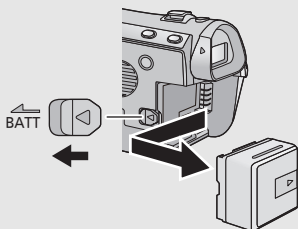

CAUTION

Danger of explosion if battery is incorrectly replaced. Replace only with the same or equivalent type recommended by the manufacturer. Dispose of used batteries according to the manufacturer's instructions.

Charging and recording time

■ Charging/Recording time

- Temperature: 25 °C/humidity: 60%

HDC-SD700				
Battery model number [Voltage/Capacity (minimum)]	Charging time	Recording mode	Maximum continuously recordable time	Actual recordable time
Supplied battery/ VW-VBG130 (optional) [7.2 V/1250 mAh]	2 h 35 min	1080/50p, HA, HG, HX	1 h 40 min	1 h
		HE		1 h 5 min
VW-VBG260 (optional) [7.2 V/2500 mAh]	4 h 40 min	1080/50p	3 h 10 min	1 h 55 min
		HA, HG, HX	3 h 15 min	2 h
		HE	3 h 20 min	
VW-VBG6 (optional)* [7.2 V/5400 mAh]	9 h 25 min	1080/50p	7 h 50 min	4 h 50 min
		HA	8 h 5 min	5 h
		HG, HX	8 h 10 min	
		HE		5 h 5 min

HDC-TM700				
Battery model number [Voltage/Capacity (minimum)]	Charging time	Recording mode	Maximum continuously recordable time	Actual recordable time
Supplied battery/ VW-VBG130 (optional) [7.2 V/1250 mAh]	2 h 35 min	1080/50p, HA, HG, HX	1 h 40 min	1 h
		HE		1 h 5 min
VW-VBG260 (optional) [7.2 V/2500 mAh]	4 h 40 min	1080/50p	3 h 10 min	1 h 55 min
		HA, HG, HX	3 h 15 min	2 h
		HE	3 h 20 min	
VW-VBG6 (optional)* [7.2 V/5400 mAh]	9 h 25 min	1080/50p	7 h 50 min	4 h 50 min
		HA	8 h 5 min	5 h
		HG, HX	8 h 10 min	
		HE		5 h 5 min

HDC-HS700

Battery model number [Voltage/ Capacity (minimum)]	Charging time	Recording destination	Recording mode	Maximum continuously recordable time	Actual recordable time
Supplied battery/ VW-VBG130 (optional) [7.2 V/1250 mAh]	2 h 35 min	HDD	1080/50p	1 h 30 min	55 min
			HA, HG, HX, HE	1 h 35 min	
		SD	1080/50p	1 h 30 min	55 min
			HA, HG, HX, HE	1 h 35 min	1 h
VW-VBG260 (optional) [7.2 V/2500 mAh]	4 h 40 min	HDD	1080/50p	2 h 55 min	1 h 45 min
			HA, HG, HX, HE	3 h	1 h 50 min
		SD	1080/50p	3 h	1 h 50 min
			HA, HG, HX, HE	3 h 5 min	1 h 55 min
VW-VBG6 (optional)* [7.2 V/5400 mAh]	9 h 25 min	HDD	1080/50p	7 h 15 min	4 h 30 min
			HA, HG, HX	7 h 30 min	4 h 40 min
				HE	
		SD	1080/50p	7 h 25 min	4 h 35 min
			HA	7 h 40 min	4 h 45 min
			HG, HX	7 h 45 min	
			HE		4 h 50 min

* The battery pack holder kit VW-VH04 (optional) is necessary.

- These times are approximations.
- **The indicated charging time is for when the battery has been discharged completely. Charging time and recordable time vary depending on the usage conditions such as high/low temperature.**

-
- The actual recordable time refers to the recordable time when repeatedly starting/stopping recording, turning the unit on/off, moving the zoom lever etc.
 - The batteries heat up after use or charging. This is not a malfunction.

Battery capacity indication

- The display changes as the battery capacity reduces.



If there is less than 3 minutes remaining, then [one segment icon] will become red. If the battery discharges, then [empty icon] will flash.

- The remaining battery capacity is displayed when using the Panasonic battery that you can use for this unit. The actual time can vary depending on your actual use.
- If the actual remaining time exceeds 9 hours 59 minutes, the indication will stay green and will not change until the remaining time falls below 9 hours 59 minutes.
- When using the AC adaptor or batteries made by other companies, the remaining battery capacity will not be shown.

Connecting to the AC outlet

The unit is in the standby condition when the AC adaptor is connected. The primary circuit is always “live” as long as the AC adaptor is connected to an electrical outlet.

Important:

While the DC cable is connected to the AC adaptor, the battery will not charge.

- Do not use the AC cable with any other equipment as it is designed only for this unit. Also, do not use the AC cable from other equipment with this unit.

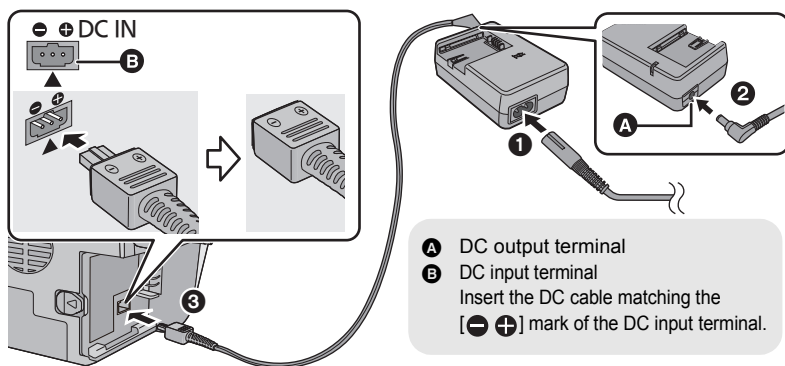

- 1** Connect the AC cable to the AC adaptor and the AC outlet.
- 2** Connect the DC cable to the AC adaptor.
- 3** Connect the DC cable to the DC input terminal [DC IN].

- When removing the AC adaptor, be sure to hold down the power button until the status indicator goes off. Then remove the AC adaptor.

Recording to a card

The unit can record still pictures or motion pictures to an SD card, built-in memory or HDD. To record to an SD card, read the following.

This unit (an SDXC compatible device) is compatible with SD Memory Cards, SDHC Memory Cards and SDXC Memory Cards. When using an SDHC memory card/SDXC memory card with other equipment, check the equipment is compatible with these memory cards.

Cards that you can use with this unit

Use SD cards conforming to Class 4 or higher of the SD Speed Class Rating* for motion picture recording.

Card type	Capacity	Motion picture recording	Still picture recording
SD Memory Card	8 MB/16 MB	Cannot be used.	Can be used.
	32 MB/64 MB/ 128 MB/256 MB	Cannot be guaranteed in operation. The recording may suddenly stop during motion picture recording depending on the SD card you use.	
	512 MB/1 GB/ 2 GB	Can be used.	
SDHC Memory Card	4 GB/6 GB/8 GB/ 12 GB/16 GB/ 24 GB/32 GB		
SDXC Memory Card	48 GB/64 GB		

* The SD Speed Class Rating is the speed standard for successive writes.

- Please confirm the latest information about SD Memory Cards/SDHC Memory Cards/SDXC Memory Cards that can be used for motion picture recording on the following website.

http://panasonic.jp/support/global/cs/e_cam
(This website is in English only.)

- 4 GB or more Memory Cards that do not have the SDHC logo or 48 GB or more Memory Cards that do not have the SDXC logo are not based on SD Memory Card Specifications.

- When the write-protect switch **A** on SD card is locked, no recording, deletion or editing will be possible on the card.

- Keep the Memory Card out of reach of children to prevent swallowing.

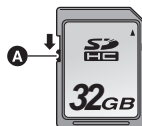

Inserting/removing an SD card

When using an SD card not from Panasonic, or one previously used on other equipment, for the first time on this unit, format the SD card. When the SD card is formatted, all of the recorded data is deleted. Once the data is deleted, it cannot be restored.

Caution:

Check that the access lamp has gone off.

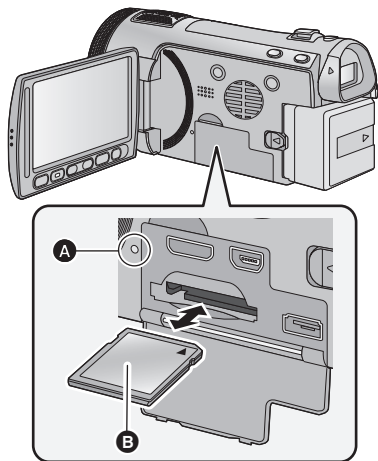

Access lamp [ACCESS] **A**

- When this unit is accessing the SD card or built-in memory, the access lamp lights up.

- 1 Open the LCD monitor.**
- 2 Open the SD card/terminal cover and insert (remove) the SD card into (from) the card slot.**

- Face the label side **B** in the direction shown in the illustration and press it straight in as far as it will go.
- Press the centre of the SD card and then pull it straight out.

- 3 Securely close the SD card/terminal cover.**

- Securely close it until it clicks.

- Do not touch the terminals on the back of the SD card.
- Do not apply strong shocks, bend, or drop the SD card.
- Electrical noise, static electricity or the failure of this unit or the SD card may damage or erase the data stored on the SD card.
- When the card access lamp is lit, do not:
 - Remove the SD card
 - Turn the unit off
 - Insert and remove the USB cable
 - Expose the unit to vibrations or shockPerforming the above while the lamp is on may result in damage to data/SD card or this unit.
- Do not expose the terminals of the SD card to water, garbage or dust.
- Do not place SD cards in the following areas:
 - In direct sunlight.
 - In very dusty or humid areas.
 - Near a heater.
 - Locations susceptible to significant difference in temperature (condensation can occur).
 - Where static electricity or electromagnetic waves occur.
- To protect SD cards, return them to their cases when you are not using them.
- Refer to the Operation Instructions (PDF format) about disposing of or giving away the SD card.

3

Turning the unit on/off

You can turn the power on and off using the power button, the LCD monitor or the viewfinder.

Turning the power on and off with the power button

Press the power button to turn on the power

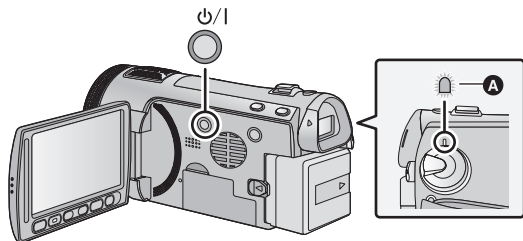
**To turn off the power**

Hold down the power button until the status indicator goes off.

A The status indicator lights.

Turning the power on and off with the LCD monitor/viewfinder

Opening the LCD monitor or extending the viewfinder turns on the power. Closing the LCD monitor/viewfinder turns off the power.

During general use, you may find it convenient to turn the power on/off using the LCD monitor or viewfinder.

■ **To turn on the power**

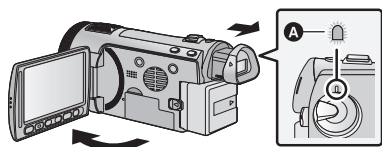

A The status indicator lights.

■ **To turn off the power**

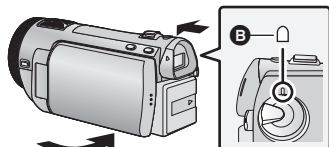



B The status indicator goes off.

- The power will not turn off unless the LCD monitor is closed and the viewfinder is retracted.
- The power will not turn off while recording motion pictures even if the LCD monitor is closed and the viewfinder is retracted.
- In the following cases, opening the LCD monitor or extending the viewfinder does not turn on the power. Press the power button to turn on the power.
 - When the unit is purchased
 - When you have turned off the power using the power button

4



Selecting a mode

Change the mode to recording or playback.

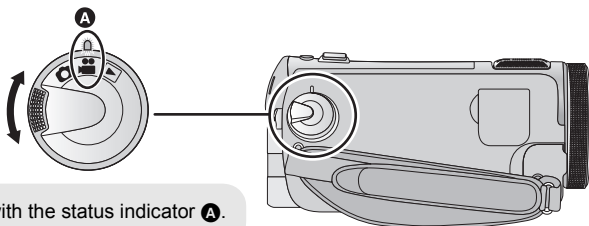
Operate the mode dial to change the mode to  ,  or  .



- Align with the status indicator **A**.

	Motion picture recording mode (→ 25)
	Still picture recording mode (→ 26)
	Playback mode (→ 28)

How to use the touch screen

You can operate by directly touching the LCD monitor (touch screen) with your finger. It is easier to use the stylus pen (supplied) for detailed operation or if it is hard to operate with your fingers.

■ Touch

Touch and release the touch screen to select icon or picture.

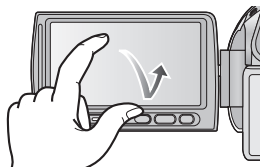

- Touch the centre of the icon.
- Touching the touch screen will not operate while you are touching another part of the touch screen.

■ About the operation icons

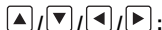

These icons are used to switch the menu and thumbnail display page, for item selection and setting etc.



Touch to return to the previous screen such as when setting menus.

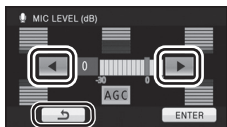

- Do not touch the LCD monitor with hard pointed tips, such as ball point pens.
- Perform the touch screen calibration when the touch is not recognised or wrong location is recognised.

Viewfinder adjustment

■ Adjusting the field of view

It adjusts the field of view to show the images on the viewfinder clearly.

Adjust the focus by rotating the eyepiece corrector dial.

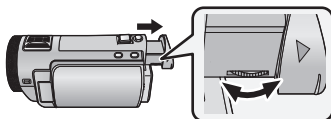

- Extend the viewfinder and close the LCD monitor to turn on the viewfinder.

Setting date and time

When the unit is turned on for the first time, a message asking you to set the date and time will appear.

Select [YES] and perform steps 2 to 3 below to set the date and time.

◇ Change the mode to  or .

1 Select the menu.

 : [SETUP] → [CLOCK SET]

2 Touch the date or time to be set, then set the desired value using /.



A Displaying the World time setting:

 [HOME]/  [DESTINATION]

- The year can be set between 2000 and 2039.
- The 24-hour system is used to display the time.

3 Touch [ENTER].



- The clock function starts at [00] seconds.
- A message prompting for World time setting may be displayed. Perform the World time setting by touching the screen.
- Touch [EXIT] or press the MENU button to complete the setting.

-
- The date and time function is driven by a built-in lithium battery.
 - When this unit is purchased, the clock is set. If the time display becomes [- -], the built-in lithium battery needs to be charged. To recharge the built-in lithium battery, connect the AC adaptor or attach the battery to this unit. Leave the unit as it is for approx. 24 hours and the battery will maintain the date and time for approx. 6 months. (The battery is still being recharged even if the power is off.)

1

Selecting a media to record [HDC-TM700/HDC-HS700]

The card, built-in memory, and HDD media can be selected separately to record motion pictures or still pictures.

- 1 Change the mode to  or .
- 2 Select the menu.

 : [MEDIA SELECT]

- 3 Touch the media to record motion pictures or still pictures.

[HDC-TM700]

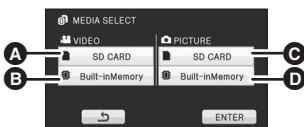

- A [VIDEO/SD CARD]
- B [VIDEO/Built-inMemory]
- C [PICTURE/SD CARD]
- D [PICTURE/Built-inMemory]

[HDC-HS700]

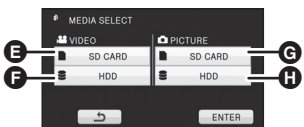

- E [VIDEO/SD CARD]
- F [VIDEO/HDD]
- G [PICTURE/SD CARD]
- H [PICTURE/HDD]



- The media is selected separately to motion pictures or still pictures is highlighted in yellow.

- 4 Touch [ENTER].

2

Recording motion
pictures

- 1 Change the mode to .
- 2 Open the LCD monitor or extend the viewfinder.
- 3 Press the recording start/stop button to start recording.

B When you begin recording,  changes to .

- 4 Press the recording start/stop button again to pause recording.

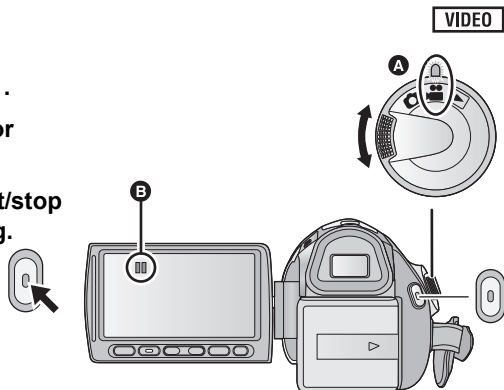

- Align with the status indicator **A**.



■ Screen indications in the motion picture recording mode



- A Recording mode**
- B Remaining time left for recording**
(When the remaining time is less than 1 minute, [R 0h00m] flashes red.)
- C Recording time elapsed**
Each time the unit is put into recording pause, the counter display will be reset to "0h00m00s".

3

Recording still pictures

- 1 Change the mode to .
- 2 Open the LCD monitor or extend the viewfinder.
- 3 Press the  button halfway.
(For auto focus only)

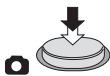



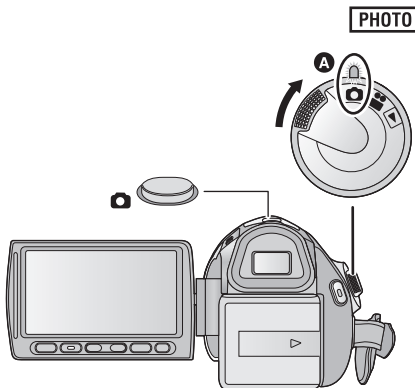
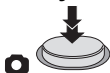





- 4 Press the  button fully.



- Align with the status indicator **A**.

■ About the screen indications in still picture recording



-  : Still picture operation indicator
-  : Flash
-  : Flash level
-  : Red eye reduction
-  : MEGA optical image stabilizer
-  : Optical image stabilizer (→ 33)
-  : Quality of still pictures
-  : Size of still pictures
- R3000: Remaining number of still pictures
(Flashes in red when [0] appears.)
- AF* : AF assist lamp

4

Intelligent auto mode

VIDEO PHOTO

The following modes appropriate for the condition are set just by pointing the unit to what you want to record.

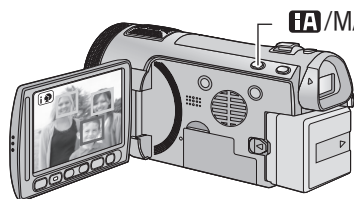

iA/MANUAL

Intelligent auto/Manual button

Press this button to switch Intelligent auto mode/Manual mode.

Mode	Scene	Effect
Portrait	When the object is a person	Faces are detected and focused automatically, and the brightness is adjusted so it is recorded clearly.
Scenery	Recording outdoors	The whole landscape will be recorded vividly without whiting out the background sky, which may be very bright.
Spotlight ^{*1}	Under a spotlight	Very bright object is recorded clearly.
Low light ^{*1}	Dark room or twilight	It can record very clearly even in a dark room or twilight.
Night portrait ^{*2}	Recording night portrait	A person and the background are recorded with near real-life brightness.
Night scenery ^{*2}	Recording night scenery	You can record night scenery vividly by slowing the shutter speed.
Macro ^{*2}	Recording zooming in on a flower etc.	This allows recording while going near to the object of recording.
Normal	Other situations	Contrast is adjusted automatically for clear image.

*1 In motion picture recording mode only

*2 In still picture recording mode only

- Depending on the recording conditions, the unit may not enter the desired mode.
- In the portrait mode, one that is bigger and close to centre of the screen will be surrounded by an orange frame.
- It is recommended using a tripod in night portrait and night scenery mode.
- Optical image stabilizer function (→ 33) is set to Active mode/ON in all modes.
- Faces cannot be detected depending on the recording conditions, such as when faces are of certain sizes or at certain tilts or when digital zoom is used.
- The microphone setup is set to surround in the Intelligent auto mode.

5

Motion picture/Still
picture playback

VIDEO PHOTO

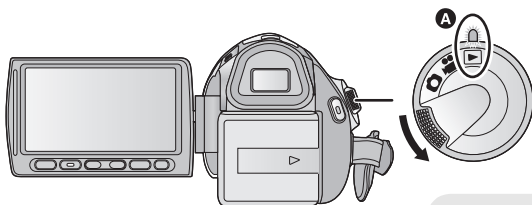

- Align with the status indicator **A**.

1 Change the mode to .

2 Touch the play mode select icon **B**.



3 Touch the desired media to be played back motion pictures or still pictures.

[HDC-SD700]

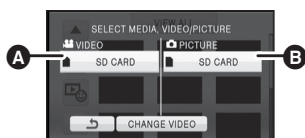

- A** [VIDEO/SD CARD]
- B** [PICTURE/SD CARD]

[HDC-TM700]

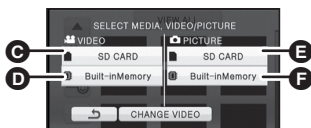

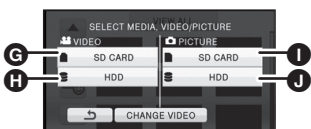

- C** [VIDEO/SD CARD]
- D** [VIDEO/Built-inMemory]
- E** [PICTURE/SD CARD]
- F** [PICTURE/Built-inMemory]

[HDC-HS700]



- G** [VIDEO/SD CARD]
- H** [VIDEO/HDD]
- I** [PICTURE/SD CARD]
- J** [PICTURE/HDD]

4 Touch the scene or the still picture to be played back.



- Next (previous) page can be displayed by touching  / .











5 Select the playback operation by touching the operation icon.



A Operation icon

- Touch  /  to display/not-display the operation icon.

Motion picture playback	Still picture playback
<p>: Playback/Pause</p> <p>: Rewind playback</p> <p>: Fast forward playback</p> <p>: Stops the playback and shows the thumbnails.</p> <p>: Displays the direct playback bar.</p>	<p>: Slide show (playback of the still pictures in numerical order) start/pause.</p> <p>: Plays back the previous picture.</p> <p>: Plays back the next picture.</p> <p>: Stops the playback and shows the thumbnails.</p>

1

Using the menu screen

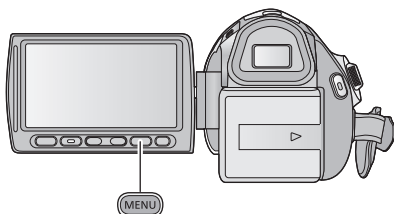

1 Press the MENU button.

2 Touch the top menu **A**.

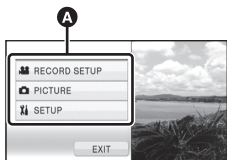

3 Touch the submenu **B**.

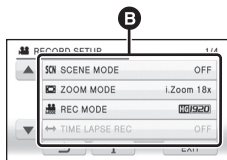

- Next (previous) page can be displayed by touching **▲**/**▼**.

4 Touch the desired item to enter the setting.

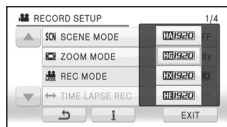

5 Touch [EXIT] or press the MENU button to exit the menu setting.

■ About **i** guide display

After touching **i**, touching the submenus and items will cause function descriptions and settings confirmation messages to appear.

- After the messages have been displayed, the guide display is cancelled.

Language selection

You can select the language on the screen display and the menu screen.

1 Press the MENU button, then touch [SETUP] → [LANGUAGE].

2 Touch [English].

1

Zoom in/out function

The maximum optical zoom ratio is 12×.

The default setting of the [ZOOM MODE] is [i.Zoom 18×]. It can be extended to a maximum of 18× during motion picture recording mode.

◇ Change the mode to  or .

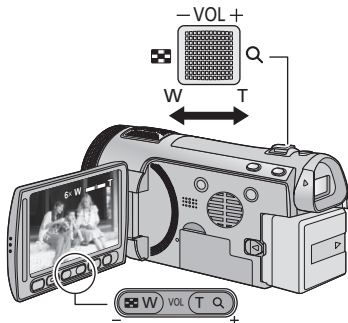

Zoom lever/Adjust zoom buttons

T side:

Close-up recording (zoom in)

W side:

Wide-angle recording (zoom out)

- The zoom speed varies depending on the range over which the zoom lever is moved.
- The adjust zoom buttons are useful for making fine adjustments to the zoom magnification.

Zoom mode

VIDEO PHOTO

Set the maximum zoom ratio for the motion picture recording mode.

• Change the mode to .

 : [RECORD SETUP] → [ZOOM MODE] → desired setting

[Opt.Zoom 12×]:	Optical zoom only (Up to 12×)
[i.Zoom 18×]:	This zoom function allows you to maintain high-definition picture quality. (Up to 18×)
[D.Zoom 30×]:	Digital zoom (Up to 30×)
[D.Zoom 700×]:	Digital zoom (Up to 700×)

• The larger the digital zoom magnification, the more the image quality is degraded.

Ring zoom

VIDEO PHOTO

Zoom operation can be done using the multi manual ring.

Zoom by rotating the ring.

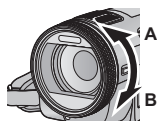

A side:

Close-up recording
(zoom in)

B side:

Wide-angle
recording (zoom out)

- The zoom speed varies depending on the speed to rotate the ring.

Extra optical zoom

PHOTO

If the number of the recording pixels is set to anything other than the maximum number of recording pixels in still picture recording mode, the still picture can be recorded with a zoom ratio of a maximum of 25× without degrading the picture quality.

- Extra optical zoom ratio varies depending on the setting of [PICTURE SIZE] and [ASPECT RATIO].

■ Extra optical zoom mechanism

When you set the picture size to $0.3m$, the maximum $12.2m$ area is cropped to the centre $0.3m$ area, allowing a picture with a higher zoom effect.

- If you take your finger off the zoom lever during zoom operation, the operation sound may be recorded. When returning the zoom lever to the original position, move it quietly.
- When the zoom magnification is 12×, the subjects are focused at about 1.2 m or more.
- When the zoom magnification is 1×, this unit can focus on a subject approx. 4 cm away from the lens.
- The zoom speed does not vary when operating with the adjust zoom buttons and the remote control.

Optical image stabilizer function

VIDEO PHOTO

Optical image stabilizer can stabilize the image without decreasing the image quality as much.

◇ Change the mode to  or .

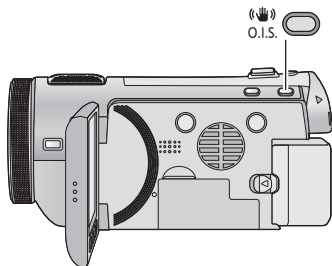

Optical image stabilizer button

Pressing the button changes the optical image stabilizer setting.

(Motion picture recording mode)

 →  → OFF

(Still picture recording mode)

₁ / ₂ → ₁ / ₂ → OFF

- Switch to manual mode before setting the Optical Image Stabilizer function to off.

: **Active mode**

This setting gives more stabilization and is suitable for recording when walking.

: **ON**

This setting is suitable for recording in a stable state such as scenery. We recommend recording with a tripod in motion picture recording mode.

■ Changing the optical image stabilizer function when in still picture recording mode





[MENU] : [RECORD SETUP] → [O.I.S.] → [MODE1] or [MODE2]

[MODE1]:

The function works all the time.

[MODE2]:

The function works when the  button is pressed. We recommend you are recording yourself or recording with a tripod in still picture recording mode.

- When in [MODE1], ₁ / ₁ appears. When in [MODE2], ₂ / ₂ appears.

- Stabilization may not be possible under strong shaking conditions.

1

Deleting scenes/still pictures

Deleted scenes/still pictures cannot be restored, so perform appropriate confirmation of the contents before proceeding with deletion.

- ◇ Change the mode to  .



To delete by confirming images being played back

Press the  button while scenes or still pictures to be deleted are being played back.

■ Deleting multiple scenes/still pictures from the thumbnail display

1 Press the  button while the thumbnail view screen is displayed.

2 Touch [ALL SCENES] or [SELECT].

- When [ALL SCENES] is selected, all the scenes or still pictures on the selected media will be deleted.
(In case of playing back scenes or still pictures by date, all the scenes or still pictures on the selected date will be deleted.)
- Protected scenes/still pictures cannot be deleted.

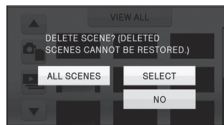

3 (Only when [SELECT] is selected in step 2)

Touch the scene/still picture to be deleted.

- When touched, the scene/still picture is selected and the  indication appears on the thumbnails. Touch the scene/still picture again to cancel the operation.
- Up to 99 scenes can be selected to be deleted.

4 (Only when [SELECT] is selected in step 2)

Touch [Delete] or press the  button.

- To continuously delete other scenes/still pictures, repeat steps 3-4

When you stop deleting halfway

Touch [CANCEL] or press the MENU button while deleting.

- The scenes or still pictures that have already been deleted when the deletion is cancelled cannot be restored.

To complete editing

Press the MENU button.

Please be aware that if a medium is formatted, then all the data recorded on the medium will be erased and cannot be restored. Back up important data on a PC, DVD disc etc.

Select the menu. (→ 30)

HDC-SD700

 : [SETUP] → [FORMAT CARD]

HDC-TM700

 : [SETUP] → [FORMAT MEDIA] → [SD CARD] or [Built-inMemory]

HDC-HS700

 : [SETUP] → [FORMAT MEDIA] → [SD CARD] or [HDD]

- When formatting is complete, touch [EXIT] to exit the message screen.
- Perform a physical formatting of the SD card when the SD card is to be disposed/transferred. (Refer to the Operation Instructions (PDF format))
- **HDC-TM700** / **HDC-HS700**
Perform a physical formatting of the built-in memory/HDD when this unit is to be disposed/transferred. (Refer to the Operation Instructions (PDF format))

- Do not turn this unit off or remove the SD card, while formatting. Do not expose the unit to vibrations or shock.

Use this unit to format media.

Formatting built-in memory or HDD is only available with this unit.

Do not format an SD card using any other equipment such as a PC. The card may not be used on this unit.

1

Watching Video/Pictures on your TV

VIDEO PHOTO

Confirm the terminals on your TV and use a cable compatible with the terminals. Image quality may vary with the connected terminals.

- ① High quality
- ② HDMI terminal
- ③ Component terminal
- ④ Video terminal

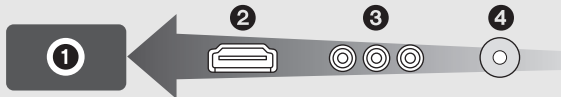

- Use the supplied AV multi cable. Check the output settings when connecting the component terminal or the video terminal with the AV multi cable.
- Use of the following Panasonic HDMI mini cables is recommended to connect the unit to the HDMI terminal.
- HDMI is the interface for digital devices. If you connect this unit to a HDMI compatible high definition TV and then play back the recorded high definition images, you can enjoy them in high resolution with high quality sound.

1 Connect this unit to a TV.

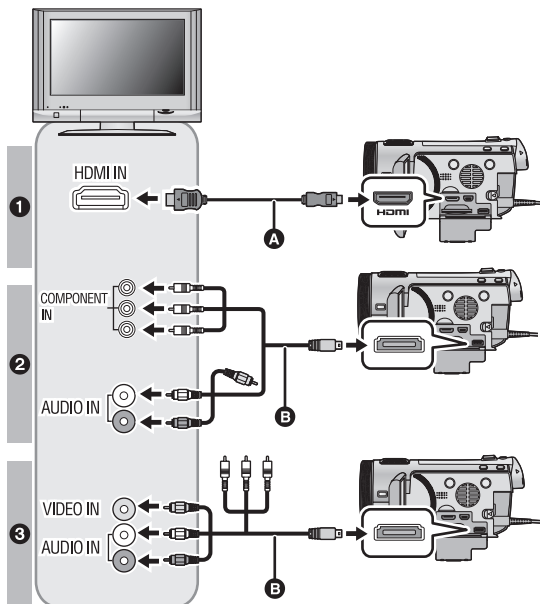

- A HDMI mini cable (optional)
- Be sure to connect to the HDMI terminal.
- B AV multi cable (supplied)

Picture quality

- ① High definition images when connecting to HDMI terminal
- ② High definition images when connecting to component terminal compatible with 1080i Standard images when connecting to component terminal compatible with 576i
- ③ Standard images when connecting to video terminal

- Check that the plugs are inserted as far as they go.
- Do not use any other cables except a genuine Panasonic HDMI mini cable (RP-CDHM15, RP-CDHM30; optional).
- Do not use any other AV multi cables except the supplied one.
- When connecting to the component terminal of the TV, the yellow plug of the AV multi cable is not required.
- When connecting to the AV terminal of the TV, the component plug of the AV multi cable is not required.

2 Select the video input on the TV.

- Example:
Select the [HDMI] channel with a HDMI mini cable.
Select the [Component] or [Video 2] channel with an AV multi cable.
(The name of the channel may differ depending on the connected TV.)
- Check the input setting (input switch) and the audio input setting on the TV. (For more information, please read the operating instructions for the TV.)

3 Change the mode to to play back.

Cables	Reference items
A HDMI mini cable (optional)	<ul style="list-style-type: none"> • Connecting with a HDMI mini cable • Listening in 5.1 channel sound • Playback using VIERA Link (HDAVI Control™)
B AV multi cable (supplied)	<ul style="list-style-type: none"> • Connecting with the AV multi cable

Specifications

High Definition Video Camera

Information for your safety

Power source:	DC 9.3 V (When using AC adaptor) DC 7.2 V (When using battery)
Power consumption:	Recording: <div style="border: 1px solid black; padding: 2px; display: inline-block;">HDC-SD700</div> 6.0 W <div style="border: 1px solid black; padding: 2px; display: inline-block;">HDC-TM700</div> 6.0 W <div style="border: 1px solid black; padding: 2px; display: inline-block;">HDC-HS700</div> 6.3 W

Signal system	1080/50p, 1080/50i
Recording format	1080/50p: Original format HA/HG/HX/HE: AVCHD format compliant
Image sensor	1/4.1" 3MOS image sensor Total: 3050 K×3 Effective pixels: Motion picture: 2530 K×3 (16:9) Still picture: 2320 K×3 (4:3), 2630 K×3 (3:2), 2530 K×3 (16:9)
Lens	Auto Iris, F1.5 to F2.8 Focal length: 3.45 mm to 41.4 mm Macro (Full range AF) 35 mm equivalent: Motion picture: 35 mm to 420 mm (16:9) Still picture: 38.8 mm to 466 mm (4:3) 35.7 mm to 428 mm (3:2) 35 mm to 420 mm (16:9) Minimum focus distance: Normal: Approx. 4 cm (Wide)/Approx. 1.2 m (Tele) Tele macro: Approx. 70 cm (Tele) Intelligent auto Macro: Approx. 1 cm (Wide)/Approx. 70 cm (Tele)
Filter diameter	46 mm
Zoom	12× optical zoom, 18× i.Zoom, 30×/700× digital zoom
Monitor	3" wide LCD monitor (Approx. 230 K dots)

Viewfinder	0.27" wide EVF (Approx. 123 K dots)	
Microphone	5.1 channel surround microphone (with a zoom microphone/focus microphone function)	
Speaker	1 round speaker, dynamic type	
White balance adjustment	Auto tracking white balance system	
Standard illumination	1,400 lx	
Minimum required illumination	Approx. 1.6 lx (1/25 in low light mode) Approx. 1 lx with the colour night view function	
AV multi connector video output level	Component video out put level: Y: 1.0 Vp-p, 75 Ω Pb: 0.7 Vp-p, 75 Ω Pr: 0.7 Vp-p, 75 Ω AV video output level: 1.0 Vp-p, 75 Ω, PAL system	
HDMI mini connector video output level	HDMI™ (x.v.Colour™) 1080p/1080i/576p	
AV multi connector audio output level (Line)	316 mV, 600 Ω, 2 ch	
Headphone output	77 mV, 32 Ω (Stereo mini jack)	
HDMI mini connector audio output level	Dolby Digital/Linear PCM	
MIC input	-70 dBV (Mic sensitivity -50 dB equivalent, 0 dB=1 V/Pa, 1 kHz) (Stereo mini jack)	
USB	SD card	Read/Write (No copyright protection support)
	Built-in memory	HDC-TM700 Read only
	HDD	HDC-HS700 Read only
	Hi-Speed USB (USB 2.0), USB terminal Type Mini AB USB host function (for DVD burner)	
Flash	Available range: Approx. 1.0 m to 2.5 m	
Dimensions	HDC-SD700 HDC-TM700	66 mm (W)×69 mm (H)×138 mm (D) (excluding projecting parts)
	HDC-HS700	65 mm (W)×69 mm (H)×138 mm (D) (excluding projecting parts)

Mass	HDC-SD700	Approx. 375 g [without battery (supplied) and an SD card (optional)]
	HDC-TM700	Approx. 380 g [without battery (supplied)]
	HDC-HS700	Approx. 450 g [without battery (supplied)]
Mass in operation	HDC-SD700	Approx. 435 g [with battery (supplied) and an SD card (optional)]
	HDC-TM700	Approx. 440 g [with battery (supplied)]
	HDC-HS700	Approx. 510 g [with battery (supplied)]
Operating temperature	0 °C to 40 °C	
Operating humidity	10% to 80%	
Battery operation time	See page 15	

Motion pictures

Recording media	SD card	SD Memory Card (FAT12 and FAT16 system compliant) SDHC Memory Card (FAT32 system compliant) SDXC Memory Card (exFAT system compliant) Refer to page 18 for details on SD cards usable in this unit.	
	Built-in memory	HDC-TM700	32 GB
	HDD	HDC-HS700	240 GB
Compression	MPEG-4 AVC/H.264		
Recording mode and transfer rate	1080/50p: Approx. 28 Mbps (VBR) HA: Approx. 17 Mbps (VBR) HG: Approx. 13 Mbps (VBR) HX: Approx. 9 Mbps (VBR) HE: Approx. 5 Mbps (VBR)		
Picture size	1080/50p: 1920×1080/50p HA/HG/HX/HE: 1920×1080/50i		
Audio compression	Dolby Digital/5.1 ch (built-in microphone), 2 ch (built-in microphone/external microphone)		

Still pictures

Recording media	SD card	SD Memory Card (FAT12 and FAT16 system compliant) SDHC Memory Card (FAT32 system compliant) SDXC Memory Card (exFAT system compliant) Refer to page 18 for details on SD cards usable in this unit.	
	Built-in memory	HDC-TM700	32 GB
	HDD	HDC-HS700	240 GB
Compression		JPEG (Design rule for Camera File system, based on Exif 2.2 standard), DPOF corresponding	
Picture size		Picture aspect [4:3]: 4032×3024/3200×2400/2560×1920/640×480 Picture aspect [3:2]: 4608×3072/3600×2400/2880×1920 Picture aspect [16:9]: 4864×2736/3840×2160/3072×1728/1920×1080	

AC adaptor

Information for your safety

Power source:	AC 110 V to 240 V, 50/60 Hz
Power consumption:	19 W
DC output:	DC 9.3 V, 1.2 A (Unit operation) DC 8.4 V, 0.65 A (Battery charging)

Dimensions	92 mm (W)×33 mm (H)×61 mm (D)
Mass	Approx. 115 g

Specifications may change without prior notice.

About copyright

■ Carefully observe copyright laws

Recording of pre-recorded tapes or discs or other published or broadcast material for purposes other than your own private use may infringe copyright laws. Even for the purpose of private use, recording of certain material may be restricted.

■ Licenses

- SDXC Logo is a trademark of SD-3C, LLC.
- "AVCHD" and the "AVCHD" Logo are trademarks of Panasonic Corporation and Sony Corporation.
- Manufactured under license from Dolby Laboratories.
Dolby and the double-D symbol are trademarks of Dolby Laboratories.
- HDMI, the HDMI Logo, and High-Definition Multimedia Interface are trademarks or registered trademarks of HDMI Licensing LLC in the United States and other countries.
- HDAVI Control™ is a trademark of Panasonic Corporation.
- "x.v.Colour" is trademark.
- LEICA is a registered trademark of Leica Microsystems IR GmbH and DICOMAR is a registered trademark of Leica Camera AG.
- Microsoft®, Windows® and Windows Vista® are either registered trademarks or trademarks of the Microsoft Corporation in the United States and/or other countries.
- Microsoft product screen shot(s) reprinted with permission from Microsoft Corporation.
- IBM and PC/AT are registered trademarks of International Business Machines Corporation of the U.S.
- Intel®, Core™, Pentium® and Celeron® are the registered trademarks or trademarks of the Intel Corporation in the United States and other countries.

- AMD Athlon™ is a trademark of the Advanced Micro Devices, Inc.
- iMovie and Mac are trademarks of Apple Inc., registered in the U.S. and other countries.
- PowerPC is a trademark of International Business Machines Corporation.
- Other names of systems and products mentioned in these instructions are usually the registered trademarks or trademarks of the manufacturers who developed the system or product concerned.

This product is licensed under the AVC patent portfolio license for the personal and non-commercial use of a consumer to (i) encode video in compliance with the AVC Standard ("AVC Video") and/or (ii) decode AVC Video that was encoded by a consumer engaged in a personal and non-commercial activity and/or was obtained from a video provider licensed to provide AVC Video. No license is granted or shall be implied for any other use. Additional information may be obtained from MPEG LA, LLC. See <http://www.mpegla.com>.

Reading the Operating Instructions (PDF format)

- You have practised the basic operations introduced in these operating instructions and want to progress to advanced operations.
- You want to check the Troubleshooting.

In these kinds of situations refer to Operating Instructions (PDF format) recorded on the CD-ROM containing the Operating Instructions (supplied).

■ For Windows

1 Turn the PC on and insert the CD-ROM containing the Operating Instructions (supplied).

2 Select the desired language and then click [Operating Instructions] to install.

(Example: When an English language OS)

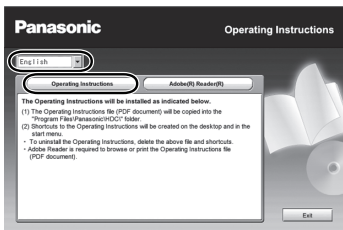

3 Double click the "SD700_TM700_HS700 Operating Instructions" shortcut icon on the desktop.

■ When the Operating Instructions (PDF format) will not open

You will need Adobe Acrobat Reader 4.0 or later or Adobe Reader 6.0 or later to browse or print the Operating Instructions (PDF format).

Download and install a version of Adobe Reader that you can use with your OS from the following Web Site.

<http://get.adobe.com/reader/otherversions>

If using the following OS

- Windows 2000 SP4
- Windows XP SP2/SP3
- Windows Vista SP1/SP2
- Windows 7

Insert the CD-ROM containing the Operating Instructions (supplied), click [Adobe(R) Reader(R)] and then follow the messages on the screen to install.

■ To uninstall the Operating Instructions (PDF format)

Delete the PDF file from the "Program Files\Panasonic\HDC\" folder.

- When the contents in the Program Files folder cannot be displayed, click the [Show the contents of this folder] to display them.

■ For Mac

1 Turn the PC on and insert the CD-ROM containing the Operating Instructions (supplied).

2 Open the "Manual" folder in "VF0613" and then copy the PDF file with the desired language inside the folder.

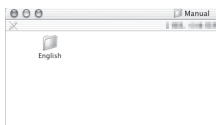

3 Double click the PDF file to open it.

Panasonic Corporation
Web site: <http://panasonic.net>

© Panasonic Corporation 2010