

# Panasonic<sup>®</sup>

## Operating Instructions

Digital Cordless Answering System

Model No. **KX-TG2521BX**

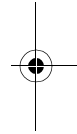
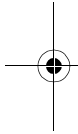

***Before initial use, see “Getting Started” on page 7.***

**Thank you for purchasing a Panasonic product.**

Please read these operating instructions before using the unit and save them for future reference.

This unit is compatible with Caller ID. You must subscribe to the appropriate service offered by your service provider/telephone company.

**Please access our online customer survey:  
<http://panasonic.net/pcc/tel/q>**

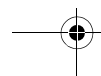
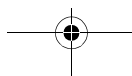

**Table of Contents**

<b>Introduction</b>	
Accessory information . . . . .	3
<b>Important Information</b>	
For your safety . . . . .	4
Important safety instructions . . . . .	5
For best performance . . . . .	5
Other information. . . . .	6
Specifications . . . . .	6
<b>Getting Started</b>	
Setting up . . . . .	7
Note when setting up. . . . .	8
Controls . . . . .	9
Display. . . . .	9
Turning the power on/off . . . . .	10
Initial settings. . . . .	10
One touch eco mode . . . . .	11
<b>Making/Answering Calls</b>	
Making calls. . . . .	12
Answering calls . . . . .	12
Handset locator . . . . .	13
Useful features during a call . . . . .	13
<b>Phonebook</b>	
Handset phonebook . . . . .	15
<b>Programming</b>	
Programmable settings . . . . .	16
Special programming . . . . .	19
<b>Caller ID Service</b>	
Using Caller ID service . . . . .	20
Caller list . . . . .	20
<b>Answering System</b>	
Answering system . . . . .	22
Turning the answering system on/off. . . . .	22
Greeting message. . . . .	22
Listening to messages. . . . .	23
Remote operation . . . . .	24
Answering system settings . . . . .	26
<b>Voice Mail Service</b>	
Voice mail service . . . . .	28
<b>Useful Information</b>	
Character entry . . . . .	29
Error messages . . . . .	31
Troubleshooting . . . . .	31
Wall mounting. . . . .	37
<b>Index</b>	
Index. . . . .	38

**Introduction**

**Accessory information**

**Supplied accessories**

No.	Accessory item/Part number	Quantity
①	AC adaptor/PQLV219BX	1
②	Telephone line cord	1
③	Rechargeable batteries <sup>*1</sup> / HHR-55AAAB or N4DHYYY00001	2
④	Handset cover <sup>*2</sup>	1

\*1 See page 3 for replacement battery information.

\*2 The handset cover comes attached to the handset.



**Additional/replacement accessories**

Please contact your nearest Panasonic dealer for sales information.

Accessory item	Model number
Rechargeable batteries	HHR-4DPA or HHR-4MRT <sup>*1</sup>
	Battery type: – Nickel metal hydride (Ni-MH) – 2 x AAA (R03) size for each handset
DECT repeater	KX-A272

\*1 Replacement batteries may have a different capacity from that of the supplied batteries.

## Important Information

### For your safety

To prevent severe injury and loss of life/property, read this section carefully before using the product to ensure proper and safe operation of your product.

#### WARNING

##### Power connection

- Use only the power source marked on the product.
- Do not overload power outlets and extension cords. This can result in the risk of fire or electric shock.
- Completely insert the AC adaptor/power plug into the power outlet. Failure to do so may cause electric shock and/or excessive heat resulting in a fire.
- Regularly remove any dust, etc. from the AC adaptor/power plug by pulling it from the power outlet, then wiping with a dry cloth. Accumulated dust may cause an insulation defect from moisture, etc. resulting in a fire.
- Unplug the product from power outlets if it emits smoke, an abnormal smell, or makes an unusual noise. These conditions can cause fire or electric shock. Confirm that smoke has stopped emitting and contact an authorised service centre.
- Unplug from power outlets and never touch the inside of the product if its casing has been broken open.
- Never touch the plug with wet hands. Danger of electric shock exists.

##### Installation

- To prevent the risk of fire or electrical shock, do not expose the product to rain or any type of moisture.
- Do not place or use this product near automatically controlled devices such as automatic doors and fire alarms. Radio waves emitted from this product may cause such devices to malfunction resulting in an accident.
- Do not allow the AC adaptor or telephone line cord to be excessively pulled, bent or placed under heavy objects.

##### Operating safeguards

- Unplug the product from power outlets before cleaning. Do not use liquid or aerosol cleaners.
- Do not disassemble the product.
- Do not spill liquids (detergents, cleansers, etc.) onto the telephone line cord plug, or allow it to become wet at all. This may cause a fire. If the telephone line cord plug becomes wet, immediately pull it from the telephone wall jack, and do not use.

##### Medical

- Consult the manufacturer of any personal medical devices, such as pacemakers or hearing aids, to determine if they are adequately shielded from external RF (radio frequency) energy. (The product operates in the frequency range of 1.88 GHz to 1.90 GHz, and the RF transmission power is 250 mW (max..))
- Do not use the product in health care facilities if any regulations posted in the area instruct you not to do so. Hospitals or health care facilities may be using equipment that could be sensitive to external RF energy.

#### CAUTION

##### Installation and location

- Never install telephone wiring during an electrical storm.
- Never install telephone line jacks in wet locations unless the jack is specifically designed for wet locations.
- Never touch uninsulated telephone wires or terminals unless the telephone line has been disconnected at the network interface.
- Use caution when installing or modifying telephone lines.
- The AC adaptor is used as the main disconnect device. Ensure that the AC outlet is installed near the product and is easily accessible.
- This product is unable to make calls when:
  - the handset batteries need recharging or have failed.
  - there is a power failure.

## Important Information

### Battery

- We recommend using the batteries noted on page 3. **USE ONLY rechargeable Ni-MH batteries AAA (R03) size.**
- Do not mix old and new batteries.
- Do not open or mutilate the batteries. Released electrolyte from the batteries is corrosive and may cause burns or injury to the eyes or skin. The electrolyte is toxic and may be harmful if swallowed.
- Exercise care when handling the batteries. Do not allow conductive materials such as rings, bracelets, or keys to touch the batteries, otherwise a short circuit may cause the batteries and/or the conductive material to overheat and cause burns.
- Charge the batteries provided with or identified for use with this product only, in accordance with the instructions and limitations specified in this manual.
- Only use a compatible base unit (or charger) to charge the batteries. Do not tamper with the base unit (or charger). Failure to follow these instructions may cause the batteries to swell or explode.

### Important safety instructions

When using your product, basic safety precautions should always be followed to reduce the risk of fire, electric shock, and injury to persons, including the following:

1. Do not use this product near water for example, near a bathtub, washbowl, kitchen sink, or laundry tub, in a wet basement or near a swimming pool.
2. Avoid using a telephone (other than a cordless type) during an electrical storm. There may be a remote risk of electric shock from lightning.
3. Do not use the telephone to report a gas leak in the vicinity of the leak.
4. Use only the power cord and batteries indicated in this manual. Do not dispose of batteries in a fire. They may explode. Check with local codes for possible special disposal instructions.

**SAVE THESE INSTRUCTIONS**

### For best performance

#### Base unit location/avoiding noise

The base unit and other compatible Panasonic units use radio waves to communicate with each other.

- For maximum coverage and noise-free communications, place your base unit:
  - at a convenient, high, and central location with no obstructions between the handset and base unit in an indoor environment.
  - away from electronic appliances such as TVs, radios, personal computers, wireless devices, or other phones.
  - facing away from radio frequency transmitters, such as external antennas of mobile phone cell stations. (Avoid putting the base unit on a bay window or near a window.)
- Coverage and voice quality depends on the local environmental conditions.
- If the reception for a base unit location is not satisfactory, move the base unit to another location for better reception.

#### Environment

- Keep the product away from electrical noise generating devices, such as fluorescent lamps and motors.
- The product should be kept free from excessive smoke, dust, high temperature, and vibration.
- The product should not be exposed to direct sunlight.
- Do not place heavy objects on top of the product.
- When you leave the product unused for a long period of time, unplug the product from the power outlet.
- The product should be kept away from heat sources such as radiators, cookers, etc. It should not be placed in rooms where the temperature is less than 0 °C or greater than 40 °C. Damp basements should also be avoided.
- The maximum calling distance may be shortened when the product is used in the following places: Near obstacles such as hills, tunnels, underground, near metal objects such as wire fences, etc.

### Important Information

- Operating the product near electrical appliances may cause interference. Move away from the electrical appliances.

#### Routine care

- **Wipe the outer surface of the product with a soft moist cloth.**
- Do not use benzine, thinner, or any abrasive powder.

### Other information

#### Notice for product disposal, transfer, or return

- This product can store your private/confidential information. To protect your privacy/confidentiality, we recommend that you erase information such as phonebook or caller list entries from the memory before you dispose of, transfer, or return the product.

#### Information on Disposal in other Countries outside the European Union



These symbols are only valid in the European Union. If you wish to discard these items, please contact your local authorities or dealer and ask for the correct method of disposal.

### Specifications

- **Standard:**  
DECT (Digital Enhanced Cordless Telecommunications),  
GAP (Generic Access Profile)
- **Frequency range:**  
1.88 GHz to 1.90 GHz
- **RF transmission power:**  
Approx. 10 mW (average power per channel)

- **Power source:**  
100–240 V AC, 50/60 Hz
- **Power consumption:**  
**Base unit:**  
Standby: Approx. 0.5 W  
Maximum: Approx. 3.8 W
- **Operating conditions:**  
0 °C – 40 °C, 20 % – 80 % relative air humidity (dry)

#### Note:

- Design and specifications are subject to change without notice.
- The illustrations in these instructions may vary slightly from the actual product.
- The range of the handset under maximum conditions is 60 metres indoors and 300 metres outdoors. Please note it will probably be shortened when near concrete barriers, etc.

**Getting Started**

**Setting up**

**Connections**

- Use only the supplied Panasonic AC adaptor PQLV219BX.

■ **Base unit**

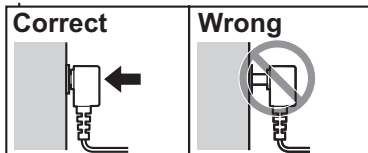
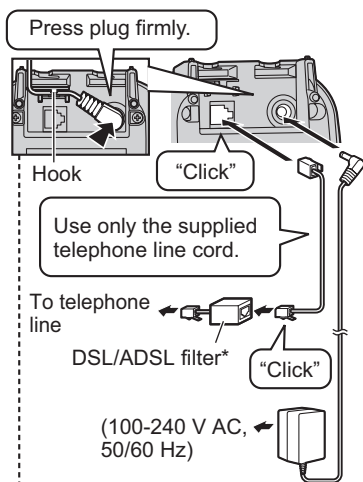

\*DSL/ADSL filter (not supplied) is required if you have DSL/ADSL service.

**Battery installation**

- USE ONLY Ni-MH batteries AAA (R03) size.
- Do NOT use Alkaline/Manganese/Ni-Cd batteries.
- Confirm correct polarities (+, -).

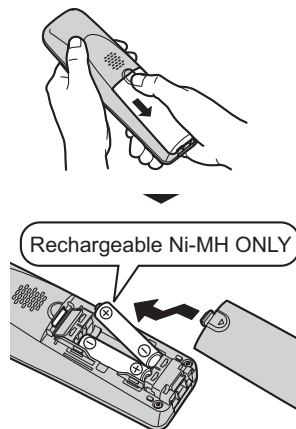

- When the language selection is displayed, see page 10.

**Battery charge**

Charge for about 7 hours.

- When the batteries are fully charged, "Fully charged" is displayed.



## Getting Started

### Note when setting up

#### Note for connections

- The AC adaptor must remain connected at all times. (It is normal for the adaptor to feel warm during use.)
- The AC adaptor should be connected to a vertically oriented or floor-mounted AC outlet. Do not connect the AC adaptor to a ceiling-mounted AC outlet, as the weight of the adaptor may cause it to become disconnected.

#### During a power failure

The unit will not work during a power failure. We recommend connecting a corded-type telephone (without AC adaptor) to the same telephone line or to the same telephone line jack using a T-adaptor.

#### Note for battery installation

- Use the supplied rechargeable batteries. For replacement, we recommend using the Panasonic rechargeable batteries noted on page 3, 5.
- Wipe the battery ends (⊕, ⊖) with a dry cloth.
- Avoid touching the battery ends (⊕, ⊖) or the unit contacts.

#### Note for battery charge

- It is normal for the handset to feel warm during charging.
- Clean the charge contacts of the handset, base unit, and charger with a soft and dry cloth once a month. Clean more often if the unit is exposed to grease, dust, or high humidity.

#### Battery level

Icon	Battery level
	High
	Medium
	Low
	Needs charging.

#### Panasonic Ni-MH battery performance (supplied batteries)

Operation	Operating time
In continuous use	18 hours max.
Not in use (standby)	170 hours max.

#### Note:

- It is normal for batteries not to reach full capacity at the initial charge. Maximum battery performance is reached after a few complete cycles of charge/discharge (use).
- Actual battery performance depends on usage and ambient environment.
- Even after the handset is fully charged, the handset can be left on the base unit or charger without any ill effect on the batteries.
- The battery level may not be displayed correctly after you replace the batteries. In this case, place the handset on the base unit or charger and let it charge for at least 7 hours.



**Getting Started**

**Controls**

**Handset**

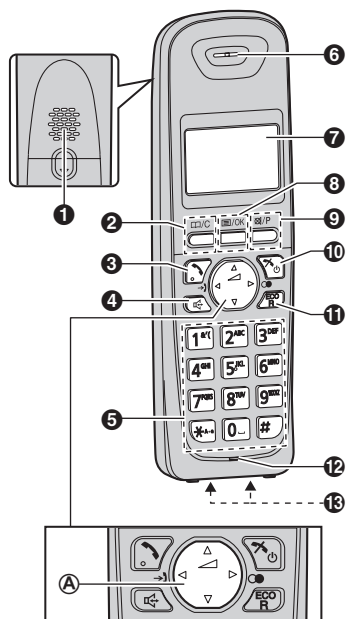

- 1 Speaker
- 2 [☐/C] (Phonebook/Clear)
- 3 [☎] (Talk)
- 4 [☎] (Speakerphone)
- 5 Dial keypad
- 6 Receiver
- 7 Display
- 8 [☰/OK] (Menu/OK)
- 9 [☒/P] (Mute/Pause)
- 10 [☒/⏻] (Off/Power)
- 11 [ECO/R]  
ECO: Eco mode shortcut key  
R: Recall/Flash
- 12 Microphone
- 13 Charge contacts

**A Navigator key**

- [▲], [▼], [←], or [→]: Scroll through various lists and items.
- 🔊 (Volume: [▲] or [▼]): Adjust the receiver or speaker volume while talking.
- [↶] (↷): Caller list: View the caller list.
- [↶] (●): Redial: View the redial list.

**Base unit**

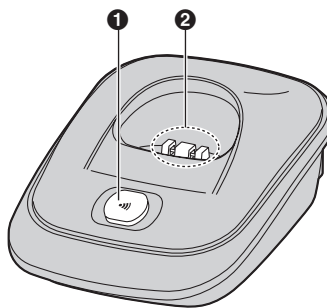





- 1 [☎] (Locator)
- 2 Charge contacts

**Display**

**Handset display items**

Item	Meaning
▽	Within range of a base unit ● When flashing slowly: Handset is searching for base unit. (page 33)
☎	Paging

## Getting Started

Item	Meaning
	Handset is on an outside call. <ul style="list-style-type: none"> <li>When flashing slowly: The call is put on hold.</li> <li>When flashing rapidly: An incoming call is now being received.</li> </ul>
ECO	The base unit transmission power is set to "Low". (page 11)
	Answering system is on. (page 22)
	Battery level
[P]	Privacy mode is on. (page 17)
	New voice mail message received.*1 (page 28)

\*1 Voice mail subscribers only

## Turning the power on/off

### Power on

Press **[⏻]** for about 1 second.

### Power off

Press **[⏻]** for about 2 seconds.

## Initial settings

### Symbol meaning:

**Example:** [▼]/[▲]: "off"

Press [▼] or [▲] to select the words in quotations.

## Display language

### Important:

- When the language selection is displayed after installing the batteries for the first time, perform step 5.

- [⏻/OK]**
- [▼]/[▲]:** "Handset Setup" → **[⏻/OK]**
- [▼]/[▲]:** "Display Setup" → **[⏻/OK]**
- [▼]/[▲]:** "Select Language" → **[⏻/OK]**
- [▼]/[▲]:** Select your desired language. → **[⏻/OK]** → **[⏻]**

### Note:

- If you select a language you cannot read: **[⏻]** → **[⏻/OK]** → **[▲]** 3 times → **[⏻/OK]** → **[▼]** 2 times → **[⏻/OK]** 2 times → **[▼]/[▲]:** Select your desired language. → **[⏻/OK]** → **[⏻]**

## Dialling mode

If you cannot make calls, change this setting according to your telephone line service. The default setting is "Tone".  
 "Tone": For tone dial service.  
 "Pulse": For rotary/pulse dial service.

- [⏻/OK]**
- [▼]/[▲]:** "Base Unit Setup" → **[⏻/OK]**

## Getting Started

- 3 [▼]/[▲]: "Dial Mode" →  
[≡/OK]
- 4 [▼]/[▲]: Select the desired setting.  
→ [≡/OK] → [✕⏻]

### Date and time

- 1 [≡/OK]
- 2 [▼]/[▲]: "Handset Setup" →  
[≡/OK]
- 3 [▼]/[▲]: "Set Date & Time" →  
[≡/OK]
- 4 Enter the current date, month, and year.  
**Example:** 15 July, 2010  
[1][5] [0][7] [1][0]
- 5 Enter the current hour and minute.  
**Example:** 9:30  
[0][9] [3][0]
  - You can select 24-hour or 12-hour clock format ("AM" or "PM") by pressing [✕].
- 6 [≡/OK] → [✕⏻]

#### Note:

- To correct a digit, press [←] or [→] to move the cursor to the digit, then make the correction.
- The date and time may be incorrect after a power failure. In this case, set the date and time again.

## One touch eco mode

The [ECO/R] button on the handset enables you to activate the eco function with one touch.

By activating eco mode, your unit can reduce the base unit transmission power by up to 90% in standby mode.

You can turn on/off one touch eco mode by just pressing [ECO/R]. The default setting is "Normal".

- When the one touch eco mode is on: "Low" is temporarily displayed and "ECO" is shown on the handset display.
- When the one touch eco mode is off: "Normal" is temporarily displayed and "ECO" goes off from the handset display.

#### Note:

- When there is another cordless phone nearby and it is in use, the base unit transmission power may not be reduced.
- Activating one touch eco mode reduces the range of the base unit in standby mode.
- If you set the repeater mode to "on" (page 19), one touch eco mode is cancelled.

## Making/Answering Calls

### Making calls

- 1 Lift the handset and dial the phone number.
  - To correct a digit, press [□/C].
- 2 [↶]
- 3 When you finish talking, press [⏏] or place the handset on the base unit or charger.

### Using the speakerphone

- 1 Dial the phone number and press [📞].
  - Speak alternately with the other party.
- 2 When you finish talking, press [⏏].

#### Note:

- For best performance, use the speakerphone in a quiet environment.
- To switch back to the receiver, press [↶].

### Adjusting the receiver or speaker volume

Press [▲] or [▼] repeatedly while talking.

### Making a call using the redial list

The last 10 phone numbers dialed are stored in the redial list (each 24 digits max.).

- 1 [▶] (☉)
- 2 [▼]/[▲]: Select the desired phone number.
- 3 [↶]

### Erasing a number in the redial list

- 1 [▶] (☉)
- 2 [▼]/[▲]: Select the desired phone number. → [☑/OK] 2 times

- 3 [▼]/[▲]: "Yes" → [☑/OK] → [⏏]

### Pause (for PBX/long distance service users)

A pause is sometimes required when making calls using a PBX or long distance service. When storing a calling card access number and/or PIN in the phonebook, a pause is also needed (page 15).

**Example:** If you need to dial the line access number "0" when making outside calls with a PBX:

- 1 [0] → [☒/P]
- 2 Dial the phone number. → [↶]

#### Note:

- A 3 second pause is inserted each time [☒/P] is pressed. Repeat as needed to create longer pauses.

### Answering calls

- 1 Lift the handset and press [↶] or [📞] when the unit rings.
  - You can also answer the call by pressing any dial key from [0] to [9], [\*], or [#]. (**Any key answer feature**)
- 2 When you finish talking, press [⏏] or place the handset on the base unit or charger.

### Auto talk

You can answer calls simply by lifting the handset off the base unit or charger. You do not need to press [↶]. To turn this feature on, see page 17.

### Adjusting the handset ringer volume

Press [▲] or [▼] repeatedly to select the desired volume while the handset is ringing for an incoming call.

## Making/Answering Calls

### Note:

- You can also program the handset ringer volume beforehand (page 17).

## Handset locator

You can locate a misplaced handset by pressing **[📞]** on the base unit.

- All registered handsets beep for 1 minute.

To stop paging, press it again or **[🔊]** on the handset.

## Useful features during a call

### Hold

This feature allows you to put an outside call on hold.

- Press **[📞/OK]**, during an outside call.
- [▼]/[▲]**: "Hold" → **[📞/OK]**
- To release hold, press **[📞]**.

### Note:

- If a call is kept on hold for more than 9 minutes, the call rings at your handset again. After 1 additional minute on hold, the call is disconnected.
- If another phone is connected to the same line (page 8), you can also take the call by lifting its handset.

### Mute

While mute is turned on, you can hear the other party, but the other party cannot hear you.

- Press **[🔇/P]** during conversation.
- To return to the conversation, press **[🔇/P]** again.

### Recall/flash

**[ECO/R]** allows you to use the special features of your host PBX such as transferring an extension call, or accessing optional telephone services.

### Note:

- To change the recall/flash time, see page 17.

### For call waiting or Call Waiting Caller ID service users

To use call waiting, you must first subscribe to call waiting from your service provider/telephone company. This feature allows you to receive calls while you are already talking on the phone. If you receive a call while on the phone, you will hear a call waiting tone. **If you subscribe to both Caller ID and Call Waiting with Caller ID services**, the 2nd caller's information is displayed after you hear the call waiting tone on the handset.

- Press **[ECO/R]** to answer the 2nd call.
- To switch between calls, press **[ECO/R]**.

### Note:

- Please contact your service provider/telephone company for details and availability of this service in your area.

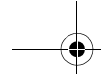

## ***Making/Answering Calls***



### **Temporary tone dialling (for rotary/pulse service users)**

You can temporarily switch the dialling mode to tone when you need to access touch-tone services (for example, telephone banking services).

- 1** Make a call.
- 2** Press [**\***] when prompted to enter your code or PIN, then press the appropriate dial keys.

**Note:**

- The dialling mode will return to pulse when you hang up.

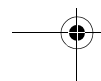
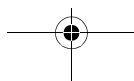
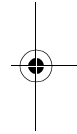
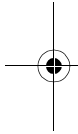

**Phonebook****Handset phonebook**

The phonebook allows you to make calls without having to dial manually. You can add 50 names and phone numbers.

**Adding entries**

- 1 [□/C] → [≡/OK]
- 2 [▼]/[▲]: "New Entry" → [≡/OK]
- 3 Enter the party's name (16 characters max.). → [≡/OK]
  - You can change the character entry mode by pressing [✕/P] (page 29).
- 4 Enter the party's phone number (24 digits max.). → [≡/OK]
- 5 [▼]/[▲]: "Save" → [≡/OK]
  - To add other entries, repeat from step 3.
- 6 [↶⏏]

**Finding and calling a phonebook entry****Scrolling through all entries**

- 1 [□/C]
- 2 [▼]/[▲]: Select the desired entry.
  - You can scroll through the phonebook entry by pressing and holding [▼] or [▲].
- 3 [↶⏏]

**Searching by first character**

- 1 [□/C]
  - Change the character entry mode if necessary:  
[✕/P] → [▼]/[▲]: Select the character entry mode. → [≡/OK]

- 2 Press the dial key ([0] to [9]) which contains the character you are searching for (page 29).
  - Press the same dial key repeatedly to display the first entry corresponding to each character located on that dial key.
  - If there is no entry corresponding to the character you selected, the next entry is displayed.
- 3 [▼]/[▲]: Scroll through the phonebook if necessary.
- 4 [↶⏏]

**Editing entries**

- 1 Find the desired entry (page 15). → [≡/OK]
- 2 [▼]/[▲]: "Edit" → [≡/OK]
- 3 Edit the name if necessary (16 characters max.; page 29). → [≡/OK]
- 4 Edit the phone number if necessary (24 digits max.). → [≡/OK]
- 5 [▼]/[▲]: "Save" → [≡/OK]
- 6 [↶⏏]

**Erasing entries**

- 1 Find the desired entry (page 15). → [≡/OK]
- 2 [▼]/[▲]: "Erase" → [≡/OK]
- 3 [▼]/[▲]: "Yes" → [≡/OK] → [↶⏏]

## Programming

### Programmable settings

You can customise the unit by programming the following features using the handset.

#### Programming by scrolling through the display menus

- 1 [OK]
- 2 Press [v] or [^] to select the desired main menu. → [OK]
- 3 Press [v] or [^] to select the desired item in sub-menu 1. → [OK]
  - In some cases, you may need to select from sub-menu 2. → [OK]
- 4 Press [v] or [^] to select the desired setting. → [OK]
  - This step may vary depending on the feature being programmed.
  - To exit the operation, press [Power Off].

#### Note:

- In the following table, < > indicates the default settings.

Main menu	Sub-menu 1	Sub-menu 2	Page	
Caller List	–	–	20	
Answer System	Play New Msg.	–	23	
	Play All Msg.	–	23	
	Erase All Msg.	–	24	
	Greeting	Start REC		23
		Play Greeting		23
		Default		23
	Settings	Remote Code		24
		Number of Rings <4 Rings>		26
		Recording Time <3 Minutes>		27
		Call Screening <On>		22
Answer On		–	22	
Answer Off	–	22		
Intercom <sup>*1</sup>	–	–	–	
Ph.Book Setup	New Entry	–	15	
	Copy All <sup>*1</sup>	–	–	



**Programming**

Main menu	Sub-menu 1	Sub-menu 2	Page	
Handset Setup	Set Date & Time	–	11	
	Ringer Setup	Ringer Volume <sup>*2</sup> <Maximum>	–	
		Ringtone <sup>*3, *4</sup> <Ringtone 1>	–	
	Display Setup	Select Language <English>		10
		Contrast <Level 3>		–
	Register H.set	–		36
	Keytones <sup>*5</sup> <On>	–		–
Auto Talk <sup>*6</sup> <Off>	–		12	
Base Unit Setup	Dial Mode <Tone>	–		10
	Recall/Flash <sup>*7</sup> <600 msec.>	–		13
	Area Code	–		19
	Privacy Mode <sup>*8</sup> <Off>	–		–
	Base Unit PIN	–		37
	Repeater Mode <Off>	–		19

\*1 Although the handset displays these items, these features are not available for this model.

\*2 When the ringer volume is turned off, “Ring off” is displayed and the handset does not ring for outside calls.  
However even when the ringer volume is set to off, the handset still rings for paging (page 13).

\*3 If you select one of the melody ringer tones, the ringer tone continues to play for several seconds even if the caller has already hung up. You may either hear a dial tone or no one on the line when you answer the call.

\*4 The preset melodies in this product are used with permission of © 2007 Copyrights Vision Inc.

\*5 Turn this feature off if you prefer not to hear key tones while you are dialling or pressing any keys, including confirmation tones and error tones.

\*6 If you subscribe to a Caller ID service and want to view the caller’s information after lifting up the handset to answer a call, turn off this feature.

\*7 The recall/flash time depends on your telephone exchange or host PBX. Contact your PBX supplier if necessary.

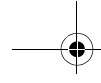

***Programming***

\*8 To prevent other users from joining your conversations with outside callers, turn this feature on.

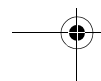
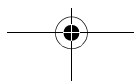
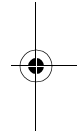
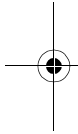

**Programming****Special programming****Storing an area code to be deleted automatically**

In some situations, phone numbers stored automatically in the caller list (page 20) will include area codes. If you do not want to dial the area code when making calls from the caller list, you can store the area code which you want the unit to delete automatically.

**Example:** You have stored the area code "123". If you make a call from the caller list to the phone number "123-456-7890", the unit dials "456-7890".

- 1 [OK]
- 2 [v]/[▲]: "Base Unit Setup" → [OK]
- 3 [v]/[▲]: "Area Code" → [OK]
- 4 Enter an area code (5 digits max.). → [OK] → [⏏]

**Increasing the range of the base unit**

You can increase the signal range of the base unit by using a DECT repeater. Please use only the Panasonic DECT repeater noted on page 3. Contact your Panasonic dealer for details.

**Important:**

- Before registering the repeater to this base unit, you must turn the repeater mode on.
- Do not use more than one repeater at a time.

**Setting the repeater mode**

- 1 [OK]
- 2 [v]/[▲]: "Base Unit Setup" → [OK]

- 3 [v]/[▲]: "Repeater Mode" → [OK]
- 4 [v]/[▲]: Select the desired setting. → [OK] → [⏏]

**Note:**

- After turning the repeater mode on or off, Y flashes on the handset momentarily. This is normal and the handset can be used once Y stops flashing.

## Caller ID Service

### Using Caller ID service

#### Important:

- This unit is Caller ID compatible. To use Caller ID features, you must subscribe to a Caller ID service. Contact your service provider/telephone company for details.

#### Caller ID features

When an outside call is being received, the caller's phone number is displayed. Caller information for the last 50 callers is logged in the caller list from the most recent call to the oldest.

- If the unit cannot receive caller information, the following is displayed:
  - “**Out of Area**”: The caller dials from an area which does not provide a Caller ID service.
  - “**Private Caller**”: The caller requests not to send caller information.
- If the unit is connected to a PBX system, caller information may not be properly received. Contact your PBX supplier.

#### Missed calls

If a call is not answered, the unit treats it as a missed call and “**Missed Call**” is displayed. This lets you know if you should view the caller list to see who called while you were away.

#### Note:

- Even when there are unviewed missed calls, “**Missed Call**” disappears from the standby display if the following operation is performed by one of the registered handsets:
  - Being replaced on the base unit or charger.
  - Pressing [**✕**].

#### Phonebook name display

When caller information is received and it matches a phone number stored in the phonebook, the stored name in the phonebook is displayed and logged in the caller list.

### Caller list

#### Important:

- Make sure the unit's date and time setting is correct (page 11).

#### Viewing the caller list and calling back

- 1 [**←**] (**→**)
- 2 Press [**▼**] to search from the most recent call, or press [**▲**] to search from the oldest call.
- 3 To call back, press [**↶**]. To exit, press [**✕**].

#### Note:

- If the entry has already been viewed or answered, “**✓**” is displayed.
- If you do not want to dial the area code when making calls from the caller list, you can store the area code which you want the unit to delete automatically (page 19).

#### Editing a caller's phone number before calling back

- 1 [**←**] (**→**)
- 2 [**▼**]/[**▲**]: Select the desired entry. → [**☐**/OK]
- 3 [**▼**]/[**▲**]: “**Edit and Call**” → [**☐**/OK]
- 4 Edit the number.
  - Press dial key ([**0**] to [**9**]) to add, [**☐**/C] to delete.

**5** [↶]

---

**Erasing caller information**

- 1 [↶] (↷)
- 2 [▼]/[▲]: Select the desired entry.  
→ [OK]
- 3 [▼]/[▲]: "Erase" or "Erase All"  
→ [OK]
- 4 [▼]/[▲]: "Yes" → [OK] →  
[↵]

---

**Storing caller information to the phonebook**

- 1 [↶] (↷)
- 2 [▼]/[▲]: Select the desired entry.  
→ [OK]
- 3 [▼]/[▲]: "Add Phonebook" →  
[OK]
- 4 To store the name, continue from step 3, "Adding entries", page 15.

## Answering System

### Answering system

The answering system can answer and record calls for you when you are unavailable to answer the phone. You can also set the unit to play a greeting message but not to record caller messages by selecting "Greeting Only" as the recording time setting (page 27).

#### Important:

- When callers leave messages, the unit records the day and time of each message. Make sure the date and time have been set correctly (page 11).
- Answering system announcements are in English only.

### Memory capacity (including your greeting message)

The total recording capacity is about 20 minutes. A maximum of 64 messages can be recorded.

#### Note:

- If message memory becomes full, "Messages Full" is shown on the handset display.
- When the message memory becomes full:
  - If you use the pre-recorded greeting message, the unit automatically switches to another pre-recorded greeting message asking callers to call again later.
  - If you recorded your own greeting message, the same message is still announced to callers even though their messages are not recorded.

### Turning the answering system on/off

The answering system is preset to on.

- 1 [≡/OK]
- 2 [▼]/[▲]: "Answer System" → [≡/OK]
- 3 [▼]/[▲]: Select "Answer On" or "Answer Off". → [≡/OK] → [↻⏻]

#### Note:

- When the answering system is turned on,  is displayed.

### Call screening

While a caller is leaving a message, you can listen to the call through the handset's speaker. To adjust the speaker volume, press [▲] or [▼] repeatedly. You can answer the call by pressing [↻] on the handset. The default setting is "On".

- 1 [≡/OK]
- 2 [▼]/[▲]: "Answer System" → [≡/OK]
- 3 [▼]/[▲]: "Settings" → [≡/OK]
- 4 [▼]/[▲]: "Call Screening" → [≡/OK]
- 5 [▼]/[▲]: Select the desired setting. → [≡/OK] → [↻⏻]

### Greeting message

When the unit answers a call, a greeting message is played to callers.

You can use either:

- your own greeting message
- pre-recorded greeting message

## Answering System

### Recording your greeting message

You can record your own greeting message.

- 1 [OK]
- 2 [v]/[▲]: "Answer System" → [OK]
- 3 [v]/[▲]: "Greeting" → [OK]
- 4 [v]/[▲]: "Start REC" → [OK]
- 5 [v]/[▲]: "Yes" → [OK]
- 6 After a beep sounds, hold the handset about 20 cm away and speak clearly into the microphone (2 minutes max.).
- 7 Press [OK] to stop recording.
- 8 [Power]

### Using a pre-recorded greeting message

The unit provides 2 pre-recorded greeting messages:

- If you erase or do not record your own greeting message, the unit plays a pre-recorded greeting asking callers to leave a message.
- If the message recording time (page 27) is set to "Greeting Only", callers' messages are not recorded and the unit plays a different pre-recorded greeting message asking callers to call again.

### Resetting to a pre-recorded greeting message

If you want to use a pre-recorded greeting message once you record your own greeting message, you need to erase your own greeting message.

- 1 [OK]

- 2 [v]/[▲]: "Answer System" → [OK]
- 3 [v]/[▲]: "Greeting" → [OK]
- 4 [v]/[▲]: "Default" → [OK]  
2 times
- 5 [Power]

### Playing back the greeting message

- 1 [OK]
- 2 [v]/[▲]: "Answer System" → [OK]
- 3 [v]/[▲]: "Greeting" → [OK]
- 4 [v]/[▲]: "Play Greeting" → [OK]
- 5 [Power]

### Listening to messages

When new messages have been recorded, "Messages" is displayed on the handset with the total number of new messages.

- 1 [OK]
- 2 [v]/[▲]: "Answer System" → [OK]
- 3 [v]/[▲]: Select "Play New Msg." or "Play All Msg." → [OK]
- 4 When finished, press [Power].

#### Note:

- To switch to the receiver, press [Power].
- If "Messages Full" is shown on the display, "Messages" and the total number of new messages are not displayed.

## Answering System

### Operating the answering system

[**☰**]/OK → [**▼**]/[**▲**]: "Answer System" → [**☰**]/OK

Key	Operation
[ <b>▲</b> ] or [ <b>▼</b> ]	Adjust the receiver or speaker volume (during playback)
[ <b>1</b> ] or [ <b>◀</b> ]	Repeat message (during playback)*1
[ <b>2</b> ] or [ <b>▶</b> ]	Skip message (during playback)
[ <b>3</b> ]	Enter the "Settings" menu
[ <b>4</b> ]	Play new messages
[ <b>5</b> ]	Play all messages
[ <b>6</b> ]	Play greeting message
[ <b>7</b> ]/[ <b>6</b> ]	Record greeting message
[ <b>8</b> ]	Turn answering system on
[ <b>☰</b> ]/OK	Pause message*2
[ <b>9</b> ]	Stop recording Stop playback
[ <b>0</b> ]	Turn answering system off
[ <b>*</b> ]/[ <b>4</b> ]	Erase currently playing message
[ <b>*</b> ]/[ <b>5</b> ]	Erase all messages
[ <b>*</b> ]/[ <b>6</b> ]	Reset to a pre-recorded greeting message

\*1 If pressed within the first 5 seconds of a message, the previous message is played.

\*2 To resume playback:  
[**▼**]/[**▲**]: "Play" → [**☰**]/OK

### Calling back (Caller ID subscribers only)

If caller information is received for the call, you can call the caller back while listening to a message.

- 1 Press [**☰**]/OK during playback.
- 2 [**▼**]/[**▲**]: "Call Back" → [**☰**]/OK

### Editing the number before calling back

- 1 Press [**☰**]/OK during playback.
- 2 [**▼**]/[**▲**]: "Edit and Call" → [**☰**]/OK
- 3 Edit the number. → [**↶**]

### Erasing all messages

- 1 [**☰**]/OK
- 2 [**▼**]/[**▲**]: "Answer System" → [**☰**]/OK
- 3 [**▼**]/[**▲**]: "Erase All Msg." → [**☰**]/OK
- 4 [**▼**]/[**▲**]: "Yes" → [**☰**]/OK → [**↶**]

### Remote operation

Using a touch-tone phone, you can call your phone number from outside and access the unit to listen to messages or change answering system settings. The unit's voice guidance prompts you to press certain dial keys to perform different operations.

### Remote access code

A 3-digit remote access code must be entered when operating the answering system remotely. This code prevents



## Answering System

unauthorised parties from listening to your messages remotely.

### Important:

- In order to operate the answering system remotely, you must first set a remote access code.

- 1 **[M]/OK**
- 2 **[v]/[▲]: "Answer System" → [M]/OK**
- 3 **[v]/[▲]: "Settings" → [M]/OK**
- 4 **[v]/[▲]: "Remote Code" → [M]/OK**
- 5 To turn on remote operation, enter the desired 3-digit remote access code.
- 6 **[M]/OK → [✖]⏻**

### Deactivating remote operation

Press **[✖]** in step 5 on "Remote access code", page 24.

- The entered remote access code is deleted.

### Using the answering system remotely

- 1 Dial your phone number from a touch-tone phone.
- 2 After the greeting message starts, enter your remote access code.
  - The unit announces the number of new messages.
- 3 Follow the voice guidance prompts as necessary or control the unit using remote commands (page 25).
- 4 When finished, hang up.

### Note:

- You can also leave a message just as any outside caller can. After the greeting message starts, press **[✖]** to skip the greeting message and record your message after the beep.

### Voice guidance

During remote operation, the unit's voice guidance starts and prompts you to press **[1]** to perform a specific operation, or press **[2]** to listen to more available operations.

### Note:

- If you do not press any dial keys within 10 seconds after a voice guidance prompt, the unit disconnects your call.

### Remote commands

You can press dial keys to access certain answering system functions without waiting for the voice guidance to prompt you.

Key	Operation
<b>[1]</b>	Repeat message (during playback)*1
<b>[2]</b>	Skip message (during playback)
<b>[4]</b>	Play new messages
<b>[5]</b>	Play all messages
<b>[6]</b>	Play greeting message
<b>[7]</b>	Record greeting message
<b>[9]</b>	Stop recording Stop playback
<b>[0]</b>	Turn answering system off
<b>[✖][4]</b>	Erase currently playing message
<b>[✖][5]</b>	Erase all messages
<b>[✖][6]</b>	Reset to a pre-recorded greeting message (during greeting message playback)
<b>[✖][#]</b>	End remote operation (or hang up)

\*1 If pressed within the first 5 seconds of a message, the previous message is played.

## Answering System

### Turning on the answering system remotely

If the answering system is off, you can turn it on remotely.

- 1 Dial your phone number from a touch-tone phone.
- 2 Let the phone ring 15 times.
  - A long beep is heard.
- 3 Enter your remote access code within 10 seconds after the long beep.
  - The greeting message is played back.
  - You can either hang up, or enter your remote access code again and begin remote operation (page 24).

### Answering system settings

#### Number of rings before the unit answers a call

You can change the number of times the phone rings "Number of Rings" before the unit answers a call. You can select 2 to 7 rings, or "Auto".

The default setting is "4 Rings".

"Auto": The unit's answering system answers at the end of the 2nd ring when new messages have been recorded, or at the end of the 5th ring when there are no new messages. If you call your phone from outside to listen to new messages (page 25), you know that there are no new messages when the phone rings for the 3rd time. You can then hang up without being charged for the call.

- 1 [OK]

- 2 [v]/[^]: "Answer System" → [OK]
- 3 [v]/[^]: "Settings" → [OK]
- 4 [v]/[^]: "Number of Rings" → [OK]
- 5 [v]/[^]: Select the desired setting. → [OK] → [MUTE]

#### For voice mail service subscribers

To receive voice mail and use answering system properly, please note the following:

- To use the voice mail service (page 28) provided by your service provider/telephone company rather than the unit's answering system, turn off the answering system (page 22).
- To use this unit's answering system rather than the voice mail service provided by your service provider/telephone company, please contact your service provider/telephone company to deactivate your voice mail service.

If your service provider/telephone company cannot do this:

- Set this unit's "Number of Rings" setting so that this unit's answering system answers calls before the voice mail service of your service provider/telephone company does. It is necessary to check the number of rings required to activate the voice mail service provided by your service provider/telephone company before changing this setting.
- Change the number of rings of the voice mail service so that the answering system can answer the call first. To do so, contact your service provider/telephone company.

## Answering System

### Caller's recording time

You can change the maximum message recording time allowed for each caller. You can also select "Greeting Only" which sets the unit to announce a greeting message to callers but not record messages. The default setting is "3 Minutes".

- 1 [ ]/OK
- 2 [v]/[▲]: "Answer System" → [ ]/OK
- 3 [v]/[▲]: "Settings" → [ ]/OK
- 4 [v]/[▲]: "Recording Time" → [ ]/OK
- 5 [v]/[▲]: Select the desired setting. → [ ]/OK → [ ]/OK

#### Note:

- When you select "Greeting Only":
  - If you do not record your own message, the unit will play the pre-recorded greeting-only message asking callers to call again later.
  - If you use your own message, record the greeting-only message asking callers to call again later (page 23).

## Voice Mail Service

### Voice mail service

Voice mail is an automatic answering service offered by your service provider/telephone company. After you subscribe to this service, your service provider/telephone company's voice mail system answers calls for you when you are unavailable to answer the phone or when your line is busy. Messages are recorded by your service provider/telephone company, not your telephone. When you have new messages,  is displayed on the handset if message indication service is available. Please contact your service provider/telephone company for details of this service.

**Important:**

- If  still remains on the display even after you have listened to new messages, turn it off by pressing and holding **[#]** for 2 seconds.
- To use the voice mail service provided by your service provider/telephone company rather than the unit's answering system, turn off the answering system (page 22). For details, see page 26.

**Useful Information**

**Character entry**

The dial keys are used to enter characters and numbers. Each dial key has multiple characters assigned to it. The characters that can be entered depend on the character entry mode (page 29).

- Press [◀] or [▶] to move the cursor left or right.
- Press dial keys to enter characters and numbers.
- Press [□/⌫] to erase the character or number highlighted by the cursor. Press and hold [□/⌫] to erase all characters or numbers.
- Press [✱] (A→a) to switch between uppercase and lowercase.
- To enter another character located on the same dial key, press [▶] to move the cursor to the next space, then press the appropriate dial key.

**Character entry modes**

The available character entry modes are Alphabet (ABC), Numeric (0-9), Greek (ABΓ), Extended 1 (AÄÄ), Extended 2 (SŠŠ), and Cyrillic (АБВ). When in these entry modes except Numeric, you can select which character is entered by pressing a dial key repeatedly.

**When the unit displays the character entry screen:**

[☒/P] → [▼]/[▲]: Select a character entry mode. → [☑/OK]

**Note:**

- ◻ in the following tables represents a single space.

**Alphabet character table (ABC)**

0 ◻	1 & ' ( )	2 ABC	3 DEF	4 GHI	5 JKL	6 MNO	7 PQRS	8 TUV	9 WXYZ
◻ 0	◻ # & ' ( ) * , - . / 1	A B C 2	D E F 3	G H I 4	J K L 5	M N O 6	P Q R S 7	T U V 8	W X Y Z 9
		a b c 2	d e f 3	g h i 4	j k l 5	m n o 6	p q r s 7	t u v 8	w x y z 9

**Numeric entry table (0-9)**

0 ◻	1 & ' ( )	2 ABC	3 DEF	4 GHI	5 JKL	6 MNO	7 PQRS	8 TUV	9 WXYZ
0	1	2	3	4	5	6	7	8	9

**Greek character table (ABΓ)**

0 ◻	1 & ' ( )	2 ABC	3 DEF	4 GHI	5 JKL	6 MNO	7 PQRS	8 TUV	9 WXYZ
◻ 0	◻ # & ' ( ) * , - . / 1	A B Γ 2	Δ E Z 3	H Θ I 4	K Λ M 5	N Ξ O 6	Π Ρ Σ 7	T Υ Φ 8	X Ψ Ω 9

**Useful Information**

**Extended 1 character table (AÄÅ)**

0 _	1 &'()	2 ABC	3 DEF	4 GHI	5 JKL	6 MNO	7 PQRS	8 TUV	9 WXYZ
_ 0	_ # & ' ( ) * , - . / 1	A Ä Å À Á Â Ã Ä Å Æ B Ç 2	D E È É Ê Ë Ë F 3	G Ğ H I Ì Í Î Ï 4	J K L 5	M N Ñ O Ò Ó Ô Ö Ø ø 6	P Q R S Ş ß 7	T U Û Ú Ü Ü Û V 8	W X Y Z 9
		a à á â ã ä å æ b c ç 2	d e è é ê ë ë f 3	g ğ h i ì í î ï 4	j k l 5	m n ñ o ó ô ö ø 6	p q r s ş ß 7	t u û ú ü ü û v 8	w x y z 9

- The following are used for both uppercase and lowercase: ø Ş Ŵ Ŷ

**Extended 2 character table (ŠŠš)**

0 _	1 &'()	2 ABC	3 DEF	4 GHI	5 JKL	6 MNO	7 PQRS	8 TUV	9 WXYZ
_ 0	_ # & ' ( ) * , - . / 1	A Á Ā Ā B C Ĉ Ċ 2	D Ď E É Ě ě F 3	G H I Í 4	J K L Ľ Ĺ ĺ 5	M N Ń Ń O Ó Ŕ Ŗ 6	P Q R Ŗ Ŕ Š Š 7	T Ť U Ú Ů ů ú v 8	W X Y Ý Z Ž Ž Ž 9
		a á ā ā b c ĉ ċ 2	d ď e é ě ě f 3	g h i í 4	j k l ľ ĺ 5	m n ŋ ň o ó ř ŕ 6	p q r ř ŕ š š 7	t ť u ú ů ů ů v 8	w x y ý z ž ž ž 9

- The following are used for both uppercase and lowercase:

Ą Ć Ć Ę Ł Ĺ Ĺ Ĺ Ń Ŕ Ŕ Š Ů ů Ź Ž Ž

**Cyrillic character table (АБВ)**

0 _	1 &'()	2 ABC	3 DEF	4 GHI	5 JKL	6 MNO	7 PQRS	8 TUV	9 WXYZ
_ 0 Г Є І і ҃	_ # & ' ( ) * , - . / 1	А Б В Г 2	Д Е Ж З 3	И Й К Л 4	М Н О П 5	Р С Т У 6	Ф Х Ц Ч 7	Ш Щ Ъ Ы 8	Ь Э Ю Я 9

**Useful Information****Error messages**

If the unit detects a problem, one of the following messages is shown on the display.

Display message	Cause/solution
<b>Error</b>	<ul style="list-style-type: none"> <li>Recording was too short. Try again.</li> </ul>
<b>Memory Full</b>	<ul style="list-style-type: none"> <li>The phonebook memory is full. Erase unnecessary entries (page 15).</li> </ul>
<b>Messages Full</b>	<ul style="list-style-type: none"> <li>Message memory is full. Erase unnecessary messages (page 24).</li> </ul>
<b>No link to base. Reconnect AC adaptor.</b>	<ul style="list-style-type: none"> <li>The handset has lost communication with the base unit. Move closer to the base unit and try again.</li> <li>Unplug the base unit's AC adaptor to reset the unit. Reconnect the adaptor and try again.</li> <li>The handset's registration may have been cancelled. Re-register the handset (page 36).</li> </ul>

**Troubleshooting**

If you still have difficulties after following the instructions in this section, disconnect the base unit's AC adaptor and turn off the handset, then reconnect the base unit's AC adaptor and turn on the handset.

**General use**

Problem	Cause/solution
The handset does not automatically turn on even after installing charged batteries.	<ul style="list-style-type: none"> <li>Place the handset on the base unit or charger to turn on the handset.</li> </ul>
The unit does not work.	<ul style="list-style-type: none"> <li>Make sure the batteries are installed correctly (page 7).</li> <li>Fully charge the batteries (page 7).</li> <li>Check the connections (page 7).</li> <li>Unplug the base unit's AC adaptor to reset the unit and turn off the handset. Reconnect the adaptor, turn on the handset and try again.</li> <li>The handset has not been registered to the base unit. Register the handset (page 36).</li> </ul>



### Useful Information

Problem	Cause/solution
I cannot hear a dial tone.	<ul style="list-style-type: none"> <li>• Make sure that you are using the supplied telephone line cord. Your old telephone line cord may have a different wiring configuration.</li> <li>• The base unit's AC adaptor or telephone line cord is not connected. Check the connections.</li> <li>• Disconnect the base unit from the telephone line and connect the line to a known working telephone. If the working telephone operates properly, contact our service personnel to have the unit repaired. If the working telephone does not operate properly, contact your service provider/telephone company.</li> </ul>
I cannot use the intercom or phonebook copy feature.	<ul style="list-style-type: none"> <li>• These features are shared between the handsets. Although the handset displays "Intercom", "Copy A11", or "Copy", these features are not available for this model.</li> </ul>

### Programmable settings

Problem	Cause/solution
The display is in a language I cannot read.	<ul style="list-style-type: none"> <li>• Change the display language (page 10).</li> </ul>
I cannot activate the eco mode.	<ul style="list-style-type: none"> <li>• You cannot set eco mode when you set the repeater mode "On". If required, set the repeater mode to "Off" (page 19).</li> </ul>

### Battery recharge

Problem	Cause/solution
The handset beeps and/or  flashes.	<ul style="list-style-type: none"> <li>• Battery charge is low. Fully charge the batteries (page 7).</li> </ul>
I fully charged the batteries, but <ul style="list-style-type: none"> <li>–  still flashes or</li> <li>– the operating time seems to be shorter.</li> </ul>	<ul style="list-style-type: none"> <li>• Clean the battery ends (+, -) and the charge contacts with a dry cloth and charge again.</li> <li>• It is time to replace the batteries (page 7).</li> </ul>
The handset display is blank.	<ul style="list-style-type: none"> <li>• The handset is not turned on. Turn the power on (page 10).</li> </ul>



**Useful Information****Making/answering calls**

<b>Problem</b>	<b>Cause/solution</b>
∇ is flashing.	<ul style="list-style-type: none"><li>• The handset is too far from the base unit. Move closer.</li><li>• The base unit's AC adaptor is not properly connected. Reconnect AC adaptor to the base unit.</li><li>• The handset is not registered to the base unit. Register it (page 36).</li><li>• Activating one touch eco mode reduces the range of the base unit in standby mode. If required, turn eco mode off (page 11).</li></ul>
Noise is heard, sound cuts in and out.	<ul style="list-style-type: none"><li>• You are using the handset or base unit in an area with high electrical interference. Reposition the base unit and use the handset away from sources of interference.</li><li>• Move closer to the base unit.</li><li>• If you use a DSL/ADSL service, we recommend connecting a DSL/ADSL filter between the base unit and the telephone line jack. Contact your DSL/ADSL provider for details.</li><li>• Unplug the base unit's AC adaptor to reset the unit and turn off the handset. Reconnect the adaptor, turn on the handset and try again.</li></ul>
The handset does not ring.	<ul style="list-style-type: none"><li>• The ringer volume is turned off. Adjust ringer volume (page 17).</li></ul>
I cannot make a call.	<ul style="list-style-type: none"><li>• The dialling mode may be set incorrectly. Change the setting (page 10).</li><li>• The handset is too far from the base unit. Move closer and try again.</li></ul>

**Useful Information**

**Caller ID**

Problem	Cause/solution
<p>Caller information is not displayed.</p>	<ul style="list-style-type: none"> <li>● You must subscribe to a Caller ID service. Contact your service provider/telephone company for details.</li> <li>● If your unit is connected to any additional telephone equipment, remove and plug the unit directly into the wall jack.</li> <li>● If you use a DSL/ADSL service, we recommend connecting a DSL/ADSL filter between the base unit and the telephone line jack. Contact your DSL/ADSL provider for details.</li> <li>● Other telephone equipment may be interfering with this unit. Disconnect the other equipment and try again.</li> </ul>
<p>Caller information is slow to display.</p>	<ul style="list-style-type: none"> <li>● Depending on your service provider/telephone company, the unit may display the caller's information at the 2nd ring or later.</li> <li>● Move closer to the base unit.</li> </ul>
<p>The name stored in the phonebook is not fully displayed while an outside call is being received.</p>	<ul style="list-style-type: none"> <li>● Edit the phonebook entry name to fit in 1 line of text (page 15).</li> </ul>

**Useful Information****Answering system**

<b>Problem</b>	<b>Cause/solution</b>
The unit does not record new messages.	<ul style="list-style-type: none"><li>• The answering system is turned off. Turn it on (page 22).</li><li>• The message memory is full. Erase unnecessary messages (page 24).</li><li>• The recording time is set to “<b>Greeting Only</b>”. Change the setting (page 27).</li><li>• If your own greeting message is not recorded properly, callers are unable to leave a message. Record your own greeting message again (page 23).</li><li>• If you subscribe to a voice mail service, messages are recorded by your service provider/telephone company, not your telephone. Change the unit’s number of rings setting or contact your service provider/telephone company (page 26).</li></ul>
My own greeting message cannot be properly heard.	<ul style="list-style-type: none"><li>• Record your own greeting message again (page 23).</li></ul>
I cannot operate the answering system.	<ul style="list-style-type: none"><li>• A caller is leaving a message. Wait for the caller to finish.</li><li>• The handset is too far from the base unit. Move closer.</li></ul>
I cannot operate the answering system remotely.	<ul style="list-style-type: none"><li>• The remote access code is not set. Set the remote access code (page 24).</li><li>• You are entering the wrong remote access code. If you have forgotten your remote access code, enter the remote access code setting to check your current code (page 24).</li><li>• Press each key firmly.</li><li>• The answering system is turned off. Turn it on (page 26).</li></ul>

## Useful Information

### Liquid damage

Problem	Cause/solution
Liquid or other form of moisture has entered the handset/base unit.	<ul style="list-style-type: none"> <li>Disconnect the AC adaptor and telephone line cord from the base unit. Remove the batteries from the handset and leave to dry for at least 3 days. After the handset/base unit are completely dry, reconnect the AC adaptor and telephone line cord. Insert the batteries and charge fully before use. If the unit does not work properly, contact an authorised service centre.</li> </ul>

#### Caution:

- To avoid permanent damage, do not use a microwave oven to speed up the drying process.

### Registering a handset to the base unit

- Handset:**  
[/OK]
- []/[]: "Handset Setup" → [/OK]
- []/[]: "Register H.set" → [/OK]
- Base unit:**  
Press and hold [] for about 5 seconds. (No registration tone)
  - The next step must be completed within 90 seconds.
- Handset:**  
Wait until "Enter Base PIN" is displayed. → Enter the base unit PIN (default: "0000"). → [/OK]
  - If you forget your PIN, contact an authorised service centre.
  - When the handset has been registered successfully, stops flashing.

#### Note:

- If the registration fails, try to deregister the handset and then re-register it again.  
Press [/OK]. → []/[]: "Base Unit Setup" → [/OK] → [3][3][5] → [/OK] → Select the handset(s) you want to cancel by pressing the desired handset number. → [/OK] → []/[]: "Yes" → [/OK] → Repeat from step 1.

## Useful Information

### Changing the base unit PIN (Personal Identification Number)

#### Important:

- If you change the PIN, please make note of your new PIN. The unit will not reveal the PIN to you. If you forget your PIN, contact an authorised service centre.

- 1 [OK]
- 2 [v]/[^]: "Base Unit Setup" → [OK]
- 3 [v]/[^]: "Base Unit PIN" → [OK]
- 4 Enter the current 4-digit base unit PIN (default: "0000").
- 5 Enter the new 4-digit base unit PIN. → [OK] → [⏏]

## Wall mounting

#### Note:

- Make sure that the wall is strong enough to support the weight of the unit.

#### ■ Base unit

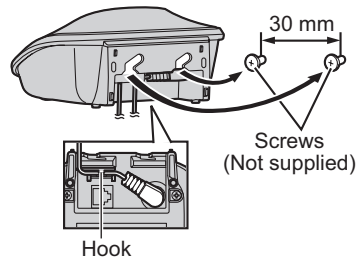

**Index**

**Index**

- A** Answering calls: 12
- Answering system: 22
  - Call screening: 22
  - Erasing messages: 24, 25
  - Greeting message: 22
  - Greeting only: 27
  - Listening to messages: 23, 25
  - Number of rings: 26
  - Recording time: 27
  - Remote access code: 24
  - Remote operation: 24
  - Turning on/off: 22, 24, 26
- Area code: 19
- Auto talk: 12
- B** Battery: 7, 8
- C** Caller ID service: 20
- Caller list: 20
- Caller list edit: 20
- Call waiting: 13
- Call Waiting Caller ID: 13
- Character entry: 29
- D** Date and time: 11
- Dialling mode: 10
- Display
  - Contrast: 17
  - Language: 10
- E** Eco mode: 11
- Error messages: 31
- H** Handset
  - Deregistration: 36
  - Locator: 13
  - Registration: 36
- Hold: 13
- K** Keytones: 17
- M** Making calls: 12
- Missed calls: 20
- Mute: 13
- P** Pause: 12
- Phonebook: 15
- PIN: 37
- Power failure: 8
- Power on/off: 10
- Privacy mode: 17
- R** Recall/flash: 13
- Redialling: 12
- Repeater: 19
- Ringer tone: 17
- S** Speakerphone: 12
- T** Temporary tone dialling: 14
- Troubleshooting: 31
- V** Voice mail: 28
- Volume
  - Receiver: 12
  - Ringer (Handset): 12
  - Speaker: 12
- W** Wall mounting: 37



---

## Notes

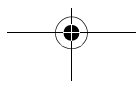
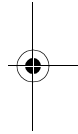
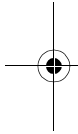



**For your future reference**

We recommend keeping a record of the following information to assist with any repair under warranty.

Serial No.

Date of purchase

(found on the bottom of the base unit)

Name and address of dealer

Attach your purchase receipt here.

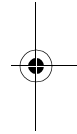
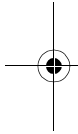

Panasonic System Networks Co., Ltd.  
1-62, 4-chome, Minoshima, Hakata-ku, Fukuoka 812-8531, Japan

**Copyright:**

This material is copyrighted by Panasonic System Networks Co., Ltd., and may be reproduced for internal use only. All other reproduction, in whole or in part, is prohibited without the written consent of Panasonic System Networks Co., Ltd.

© Panasonic System Networks Co., Ltd. 2010



\*TG2521 BX\*

**PNQX2460ZA** CC0510DL0 (A)

