

# Panasonic

## Operating Instructions

إرشادات التشغيل

دفترچه راهنما

هدایات برائے استعمال

प्रचालन अनुदश

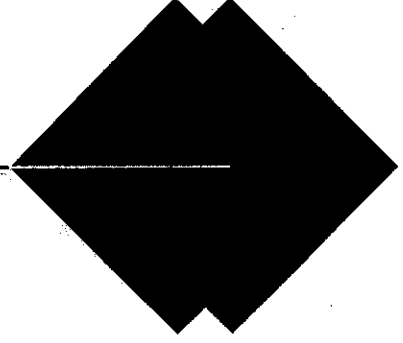

## Microwave/Convection Oven

فرن تحمیلی/مایکروویف

اجاق مائکروویو/کنوکسیون

مائکروویو/کنوکشن اوون

माइक्रोवेव/संवहन ओवन

## Model NN-C2003S/NN-C2002W

Before operating this oven, please read these instructions completely.

قبل تشغيل هذا الفرن، يرجى قراءة هذه التعليمات بالكامل.

قبل از بکارگیری این اجاق، لطفاً این دفترچه راهنما را کاملاً مطالعه نمایید.

اس اوون کو چلانے سے قبل ان ہدایات کو مکمل طور پر پڑھئے۔

इस ओवन को इस्तेमाल करने से पहले कृपया सम्पूर्ण निर्देश पढ़ लें।

## Important Safety Instructions

### Precautions in the Use of Microwave Ovens for Heating Food

#### INSPECTION FOR DAMAGE:

A microwave oven should only be used if an inspection confirms all the following items:

1. The grille is not damaged or broken.
2. The door fits squarely and securely and opens and closes smoothly.
3. The door hinges are in good condition.
4. The metal plates of a metal seal on the door are neither buckled nor deformed.
5. The door seals are neither covered with food nor have large burn marks.

#### PRECAUTIONS:

Microwave radiation from microwave ovens can cause harmful effects if the following precautions are not taken:

1. Never tamper with or deactivate the interlocking devices on the door.
2. Never poke an object, particularly a metal object, through a grille or between the door and the oven while the oven is operating.
3. Never place saucepans, unopened cans or other heavy metal objects in the oven.
4. Do not let other metallic articles, e.g. fast food foil containers, touch the side of the oven.
5. Clean the oven cavity, the door and the seals with water and a mild detergent at regular intervals. Never use any form of abrasive cleaner that may scratch or scour surfaces around the door.
6. Always use the oven with the trays or cookware recommended by the manufacturer.
7. Never operate the oven without a load (i.e. an absorbing material such as food or water) in the oven cavity unless specifically allowed in the manufacturer's literature.
8. For horizontally hinged doors, never rest heavy objects such as food containers on the door while it is open.
9. Do not place sealed containers in the microwave ovens.  
Baby bottles fitted with a screw cap or a teat are considered to be sealed containers.
10. The appliance is not intended for use by young children or infirm persons without supervision.
11. Young children should be supervised to ensure that they do not play with the appliance.

#### PRACTICAL HINTS:

1. Before using CONVECTION BAKE, COMBINATION or GRILL function for the first time, wipe excessive oil off in oven cavity and operate the oven without food and accessories on Grill 1, for 20 minutes. This will allow the oil that is used for rust protection to be burned off.
2. Exterior oven surfaces, including air vents on the cabinet and the oven door will get hot during CONVECTION BAKE, COMBINATION and GRILL. Use care when opening or closing door and when inserting or removing food and accessories.

#### WARNING

- a) The door seals and door seal areas should be cleaned with a damp cloth.  
The appliance should be inspected for damage to the door seals and door seal areas and if these areas are damaged the appliance should not be operated until it has been repaired by a service technician trained by the manufacturer.
- b) It is dangerous for anyone other than a service technician trained by the manufacturer to perform repair service.
- c) If the supply cord of this appliance is damaged, it must be replaced by the special cord available only from the manufacturer.
- d) Before use, the user should check that utensils are suitable for use in microwave ovens.
- e) Liquids or other foods must not be heated in sealed containers since they are liable to explode.
- f) Only allow children to use the oven without supervision when adequate instructions have been given so that the child is able to use the oven in a safe way and understands the hazards of improper use.
- g) Accessible parts may become hot when CONVECTION BAKE/COMBINATION /GRILL is in use children should be kept away.

## SAVE THESE INSTRUCTIONS

# Installation and Earthing Instructions

## Important Instructions

**WARNING**—To reduce the risk of burns, electric shock, fire, injury to persons or excessive microwave energy:

1. Read all instructions before using microwave oven.
2. Some products such as whole eggs and sealed containers - (for example, closed glass jars **and sealed baby bottles with a teat**) - may explode and should not be heated in microwave oven.
3. Use this microwave oven only for its intended use as described in this manual.
4. As with any appliance, close supervision is necessary when used by children.
5. Do not operate this microwave oven, if it is not working properly, or if it has been damaged or dropped.
6. Do not store or use this appliance outdoors.
7. Do not immerse cord or plug in water.
8. Keep cord away from heated surfaces.
9. Do not let cord hang over edge of table or counter.
10. To reduce the risk of fire in the oven cavity:
  - (a) Do not overcook food. Carefully attend microwave oven if paper, plastic, or other combustible materials are placed inside the oven to facilitate cooking.
  - (b) Remove wire twist-ties from bags before placing bag in oven.
  - (c) If materials inside the oven should ignite, keep oven door closed, turn oven off at the wall switch, or shut off power at the fuse or circuit breaker panel.
11. Do not remove outer panel from oven.

## Earthing Instructions

This microwave oven must be earthed. In the event of an electrical short circuit, earthing reduces the risk of electric shock by providing an escape wire for the electric current. This microwave oven is equipped with a cord having an earthing wire with an earthing plug. The plug must be plugged into an outlet that is properly installed and earthed.

**WARNING**—Improper use of the earthing plug can result in a risk of electric shock.

## Placement of Oven

1. The oven must be placed on a flat, stable surface, more than 85 cm above the floor. For correct operation, the oven must have sufficient air flow. **Allow 15 cm of space on the top of the oven, 10cm at back and 5cm on both sides. If one side of the oven is placed flush to a wall, the other side or top must not be blocked. Do not remove feet.**
  - (a) Do not block air vents. If they are blocked during operation, the oven may overheat. If the oven overheats, a thermal safety device will turn the oven off. The oven will remain inoperable until it has cooled.
  - (b) Do not place oven near a hot or damp surface such as a gas stove, electric range **or sink etc.**
  - (c) Do not operate oven when room humidity is too high.
2. The surfaces of top, back and left side of the oven become hot during operation. Do not allow the main cable to come in contact with these surfaces of the oven.

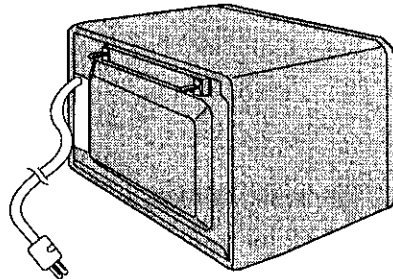

3. This oven was manufactured for household use only.
4. This oven may be built into a wall cabinet, if desired. Trim kits may be purchased from a local National dealer. See page En-18 for technical specifications.

## Circuits

Your microwave ovens should be operated on a separate circuits from other appliances. Failure to do this may cause the power board fuse to blow, and/or food to cook slower. Do not insert higher value fuse in the power board.

## Fan Motor Operation

After using the oven, the fan may rotate to cool the electric components. This is perfectly normal, and you can take out the food from the oven while the fan operates.

# General Instructions

## General Use

1. For microwave cooking, only use utensils that are suitable for use in microwave ovens.
2. In order to maintain high quality, do not operate the oven when empty. The microwave energy will reflect continuously throughout the oven if no food or water is present to absorb energy.
3. If smoke is observed, press the STOP/RESET Pad and leave the door closed in order to stifle any flames. Disconnect the power cord, or shut off power at the fuse or circuit breaker panel.
4. Do not dry clothes, newspapers or other materials in oven. They may catch on fire.
5. Do not use recycled paper products unless the paper product is labelled as safe for microwave oven use. Recycled paper products may contain impurities which may cause sparks and/or fires when used.
6. Do not use newspapers or paper bags for cooking.
7. Do not hit or strike control panel. Damage to controls may occur.
8. POT HOLDERS may be needed as heat from food is transferred to the cooking container and from the container to the Ceramic Tray. The Ceramic Tray can be very hot after removing the cooking container from the oven.
9. Do not store flammable materials next to, on top of, or in the oven. It could be a fire hazard.
10. Do not cook food directly on Ceramic Tray unless indicated in recipes. (Food should be placed in a suitable cooking utensil.)
11. **DO NOT** use this oven to heat chemicals or other non-food products. **DO NOT** clean this oven with any product that is labeled as containing corrosive chemicals. **The heating of corrosive chemicals in this oven may cause microwave radiation leaks.**
12. When using the COMBINATION mode, never place any aluminum or metal container directly on the Low Rack.  
Always insert a heat-proof, glass plate or dish between the Low Rack and the aluminum container. This will prevent sparking that may damage the oven.
13. It is recommended not to use the Low/High Rack when cooking in the MICROWAVE mode only.
14. If Ceramic Tray is hot, allow to cool before cleaning or placing in water.
15. Look at the oven from time to time when food is heated or cooked in disposal containers of plastic, paper or other combustible materials, as these types of containers ignite if overheated.

## Food

1. Do not use your oven for home canning or the heating of any closed jar. Pressure will build up and the jar may explode. In addition, the microwave oven cannot maintain the food at the correct canning temperature. Improperly canned food may spoil and be dangerous to consume.
2. Do not attempt to deep fat fry in your microwave oven.
3. Do not cook eggs in their shell and whole hard boiled eggs in microwave oven (unless otherwise stated in cookbook). Pressure will build up and the eggs will explode.
4. Potatoes, apples, egg yolks, whole squash and sausages are examples of foods with nonporous skins. This type of food must be pierced before cooking, to prevent bursting.
5. When heating liquids, e.g. soup, sauces and beverages in your microwave oven, overheating the liquid beyond boiling point can occur without evidence of bubbling. This could result in a sudden boil over the hot liquid. To prevent this possibility the following steps should be taken:
  - a) Avoid using straight-sided containers with narrow necks.
  - b) Do not overheat.
  - c) Stir the liquid before placing the container in the oven and again halfway through cooking time.
  - d) After heating, allow to stand in the oven for a short time, stirring again before carefully removing the container.
6. **DO NOT USE A CONVENTIONAL MEAT THERMOMETER IN THE MICROWAVE OVEN. To check the degree of cooking of roasts and poultry use a MICROWAVE THERMOMETER.** Alternatively, a conventional meat thermometer may be used after the food is removed from the oven. If undercooked, return meat or poultry to the oven and cook for a few more minutes at the recommended power level. It is important to ensure that meat and poultry are thoroughly cooked.
7. **COOKING TIMES given in the cookbook are APPROXIMATE.** Factors that may affect cooking time are preferred degree of moisture content, starting temperature, altitude, volume, size, shape of food and utensils used. As you become familiar with the oven, you will be able to adjust for these factors.
8. **It is better to UNDERCOOK RATHER THAN OVERCOOK foods.** If food is undercooked, it can always be returned to the oven for further cooking. If food is overcooked, nothing can be done. Always start with minimum cooking times recommended.
9. Extreme care should be taken when cooking popcorn in a microwave oven. Cook for minimum time as recommended by manufacturer. Use the directions suitable for the wattage of your microwave oven. **NEVER** leave oven unattended when popping popcorn.
10. When reheating babies bottles always remove top and teat. Liquid at the top of the bottle will be much hotter than at the bottom and must be shaken thoroughly before checking the temperature. The lid must also be removed from babies food jars, the contents must also be stirred or shaken before the temperature is checked.

# Feature Diagram

English

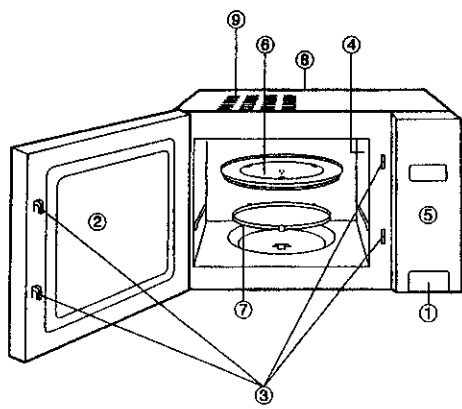

## ① Door Release Button

Opening the door during cooking will stop the cooking process without cancelling the program. Cooking resumes as soon as the door is closed and START Pad is pressed. The oven light will turn on and stay on whenever the door is opened. It is quite safe to open the door at any time during a cooking program and there is no risk of Microwave exposure.

## ② Oven Window

## ③ Door Safety Lock System

## ④ Oven Air Vent

## ⑤ Control Panel

## ⑥ Ceramic Tray

## ⑦ Roller Ring

## ⑧ Identification Plate (model number)

## ⑨ External Oven Air Vents

**NOTE:** Place the roller ring correctly, then set the ceramic tray exactly.

# Control Panel

NN-C2003S

**Microwave Power Pad**

**Grill Pad**

**Display Window**

**Auto Menu Pad**

**Timer Pad**

**Recipe Store Pad**

**Stop/Reset Pad:**

**Before cooking:** One tap clears your instructions.

**During cooking:** One tap temporarily stops the cooking process. Another tap cancels all your instructions and time of day appears in the display window.

**Turbo Defrost Pad**

**Combination Pad**

**2 Level Convection Pad**

**Convection Bake Pad**

**Sensor Reheat Pad**

**Temperature / Menu Select Dial**

**Time / Weight Dial**

**Clock Pad**

**More/Less Pads**

**Start Pad:**

One tap allows oven to begin functioning. If door is opened or STOP/RESET Pad is tapped once during oven operation, START Pad must again be pressed to restart oven.

**Quick Min. Pad**

MADE IN JAPAN  
NN-C2003S

\*The control panel of NN-C2002W has the same key layout as NN-C2003S.

### Beep Sound:

When a pad is pressed correctly, a beep will be heard. If a pad is pressed and no beep is heard, the unit has not or cannot accept the instruction. The oven will beep twice between programmed stages. At the end of preheating on Grill or Convection Bake Function, the oven will beep three times. At the end of any complete program, the oven will beep five times.

# Oven Accessories

The following chart shows you the correct use of the accessories in the oven.

English

	Ceramic Tray	Low Rack	High Rack
Microwave	YES	NO	NO
Grill	YES	NO	YES
Convection Bake	YES	YES	YES
2 Level Convection	YES	YES	YES
Combination	YES	YES	NO

## Cooking Modes; Heating Source

Microwave

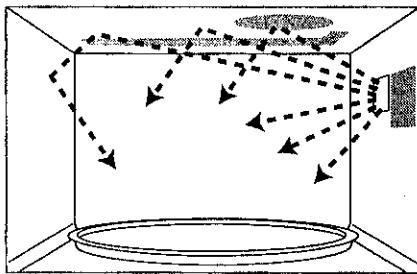

Grill

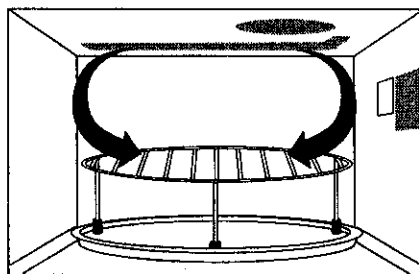

Convection Bake

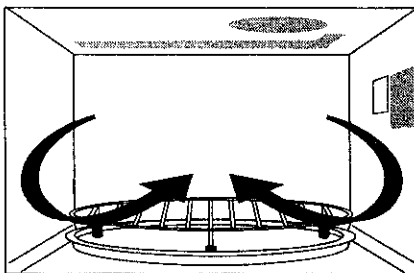

2 Level Convection

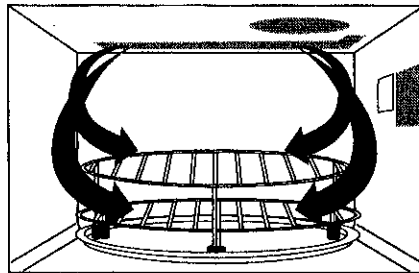

Combination

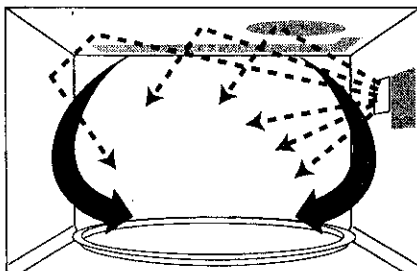

← - - - Microwave  
 ← Heat

Low Rack can be used for combination cooking.

## Operation Guide

To assist you in programming your oven, an operation guide of English will appear in the display window.

When you become familiar with your oven, the operation guide can be turned off.

### To Turn Off:

	<ul style="list-style-type: none"> <li>● Press 3 times.</li> <li>➡ "OPERATION GUIDE OFF" rolls across and colon or time of day reappears in the display window.</li> </ul>
---	--

### To Turn On:

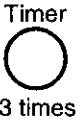
	<ul style="list-style-type: none"> <li>● Press 3 times.</li> <li>➡ "OPERATION GUIDE ON" rolls across and colon or time of day reappears in the display window.</li> </ul>
---	---

## Cook Navigator

This feature allows you to guide you through the cooking process. Once a pad has been selected, the oven will prompt you the NEXT step until cooking starts.

e.g.

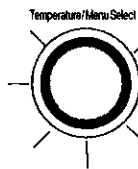

- **Set the cooking temperature.**  
e.g. After pressing the Convection Bake Pad.
- or
- **Select menu.**  
e.g. After pressing the Auto Menu Pad.

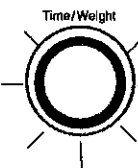

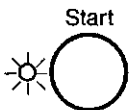

- **Set the cooking time.**  
e.g. After selecting the Micro Power level.
- or
- **Set the weight.**  
e.g. After pressing the Turbo Defrost Pad.



- **Press Start Pad.**  
e.g. After selecting the Micro Power level and time.

## To Set Clock

You can use the oven without setting the clock.

<b>1</b> 	<ul style="list-style-type: none"> <li>● Press.</li> <li>➡ Colon blinks.</li> </ul>
<b>2</b> 	<ul style="list-style-type: none"> <li>● Enter time of day using the Time / Weight Dial.</li> </ul>
<b>3</b> 	<ul style="list-style-type: none"> <li>● Press.</li> <li>➡ Colon stops blinking; time of day is entered and locked into display.</li> </ul>

### NOTE:

1. To reset time of day, repeat step 1 through step 3.
2. The clock will keep the time of day as long as oven is plugged in and electricity is supplied.
3. Max time available is 12:59. Clock is 12 hour only.

## To Use Child Safety Lock

This feature allows you to prevent operation of the oven by a young child; however, the door will open.

**Note:** Child Lock can be set when colon or time of day is displayed.

### To Set:

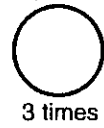

	<ul style="list-style-type: none"> <li>● Press 3 times.</li> <li>➡ "LOCK" appears in the display window.</li> </ul>
---	---

### To Cancel:

	<ul style="list-style-type: none"> <li>● Press 3 times.</li> <li>➡ "LOCK" disappears and colon or time of day appears.</li> </ul>
---	---

## To Reheat/Defrost/Cook by setting Power and Time

How do I program Power and Time?

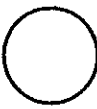
<p>1</p> <p>Micro Power</p> 	<p>•Select Micro Power Level. e.g. Press 4 times for MEDIUM.</p>
<p>2</p> <p>Time/Weight</p> 	<p>•Set Cooking Time using the Time / Weight Dial. (HIGH→ up to 30 minutes others→ up to 1 hour and 30 minutes) Time can be entered 10 second intervals up to 5 min. then 1 min. intervals.</p>
<p>3</p> <p>Start</p> 	<p>•Press. •Cooking starts. The time in the display window counts down.</p>



**NOTE:**

- For 2 or 3 stage cooking, repeat steps 1 and 2 above before pressing Start Pad.
- Micro Power Pad:**

Press	Power Level	Power
once	HIGH	1000 W
twice	DEFROST	270 W
3 times	MEDIUM-HIGH	600 W
4 times	MEDIUM	440 W
5 times	MEDIUM-LOW	250 W
6 times	LOW	100 W

## To Defrost by the Turbo Defrost Pad

This feature allows you to defrost meat, poultry and seafood by weight.

<p>1 Turbo Defrost</p> 	<p>•Press.</p>
<p>2</p> <p>Time/Weight</p> 	<p>•Set the weight using the Time / Weight Dial. (up to 3.0 Kg) Weight can be entered 0.1 Kg intervals.</p>
<p>3 Start</p> 	<p>•Press. •Defrosting time appears in the display window and begins to count down.</p>

**NOTE:**

- The shape and size of your food will determine the maximum weight the oven can accommodate.
- Stand time or power level may be programmed after Turbo Defrost.
- Oven will beep twice halfway through the defrosting time, to remind you to turn the food over, break apart, separate pieces, etc.



# To Cook on Grill by Time Setting

There are two Grill settings available.

Grill 1(HIGH) is suitable for grilling meat, chicken and fish fillets.

Grill 2(LOW) is ideal for grilling whole fish and oven bake chips and browning cheese and egg dishes.

Place a heatproof glass or ceramic dish under the High Rack to catch any drips from the roast.

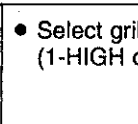
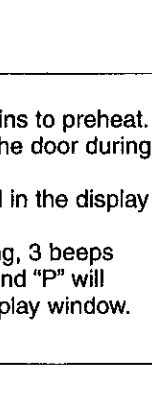
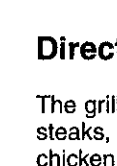
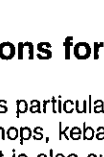
1	 <p>Grill</p>	<ul style="list-style-type: none"> <li>Select grill setting. (1-HIGH or 2-LOW)</li> </ul>
2	 <p>Start</p>	<ul style="list-style-type: none"> <li>Press.                             <ul style="list-style-type: none"> <li>The oven begins to preheat. Do not open the door during preheating. "P" is indicated in the display window.</li> <li>After preheating, 3 beeps will be heard and "P" will blink in the display window.</li> </ul> </li> </ul>
3	<p>Place food in the oven.</p> 	
4	 <p>Time/Weight</p>	<ul style="list-style-type: none"> <li>Set Cooking Time using the Time / Weight Dial. (up to 1 hour and 30 minutes) Time can be entered in 10 second intervals up to 5 min. then 1 min. intervals.</li> </ul>
5	 <p>Start</p>	<ul style="list-style-type: none"> <li>Press.                             <ul style="list-style-type: none"> <li>Cooking starts. The time in the display window counts down.</li> </ul> </li> </ul>

## Directions for Grilling:

The grill is particularly useful for thin slices of meat, steaks, chops, kebabs, sausages or pieces of chicken. It is also suitable for hot sandwiches and au gratin dishes.



The food being grilled should normally be turned over after half the grilling time. When the oven door is opened, the program is interrupted. Turn the food over, place it back in the oven, close the door and re-start the oven. While grilling, the oven door can be opened at any time to check the food.

Item	Grill Setting	Approx. Cooking Time (in minutes)
<b>FISH</b>		
Fillets 1 cm thick	1	6 to 8
1.5 cm thick	1	8 to 10
Steaks 2 cm thick	1	14 to 16
<b>WHOLE FISH</b>		
250 g to 375 g	2	10 to 12
500 g	2	14 to 16
<b>SHELLFISH</b>		
Lobster Tails		
250 g to 300 g	2	12 to 14
Sea Scallops 500 g	1	4 to 6
Prawns 500 g	2	6 to 8
<b>CHICKEN</b>		
4 half Breasts	1	15 to 18
Cut-up (whole)	1	25 to 30
8 Drumsticks	1	20 to 22
4 Thighs	1	20 to 22
16 Wings	1	18 to 22
4 Marylands	1	18 to 20
4 Kebabs	1	15 to 18
<b>BEEF</b>		
Hamburger (Approx. 3 cm thick)		
Well	1	12 to 14
Fillet Mignon (Approx. 3 cm thick)		
Rare	1	8 to 10
Medium	1	12 to 14
Steak (Approx. 3 cm thick)		
Rare	1	10 to 12
Medium	1	14 to 16
Well	1	16 to 18
<b>LAMB</b>		
Chops 2 cm thick		
Medium	1	12 to 14
Well	1	14 to 16
4 Kidneys (halved)	1	6 to 8

### NOTE:

- Place the Ceramic Tray correctly in the oven before preheating.
- If the oven door is not opened after the completion of preheating, the oven will maintain the selected Grill Power for 30 minutes from the beginning of preheating. After 30 minutes, the oven will shut off automatically and revert to the time of day.
- If preheat is not required, eliminate step 2.

# To Cook on Convection Bake by Time Setting

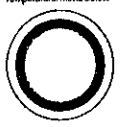
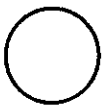
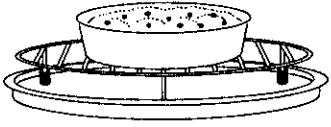
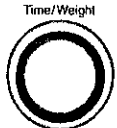
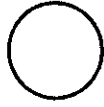
<p>1</p> <p>Conv. Bake</p>  <p>or</p> <p>2 Level Conv. Bake</p> 	<p>• Press.</p>
<p>2</p> <p>Temperature/Menu Select</p> 	<p>• Select the desired oven temperature using the Temperature / Menu Select Dial. (100 - 250°C) Refer to the chart on page En-11.</p>
<p>3</p> <p>Start</p> 	<p>• Press.</p> <ul style="list-style-type: none"> <li>☛ The oven begins to preheat. Do not open the door during preheating. "P" is indicated in the display window.</li> <li>☛ After preheating, 3 beeps will be heard and "P" will blink in the display window.</li> </ul>
<p>4 Place food in the oven.</p> 	
<p>5</p> <p>Time/Weight</p> 	<p>• Set Cooking Time using the Time / Weight Dial. (up to 9 hours and 59 minutes) Time can be entered in 1 min. intervals.</p>
<p>6</p> <p>Start</p> 	<p>• Press.</p> <ul style="list-style-type: none"> <li>☛ Cooking starts. The time in the display window counts down.</li> </ul>

## NOTE:

1. Place the Ceramic Tray correctly in the oven before preheating.
2. If the oven door is not opened after the completion of preheating, the oven will maintain the selected temperature for 30 minutes from the beginning of preheating. After 30 minutes, the oven will shut off automatically and revert to the time of day.
3. If preheat is not required, eliminate step 3.
4. When selected cooking time is less than one hour, the time counts down by seconds.
5. When selected cooking time is more than one hour, the time counts down by minutes until only "1H 00(1 hour)" remains. The display then counts down by seconds.

## One Level Convection:

Just like a conventional oven, the convection oven has a heating element to give the dry heating needed to produce crisp, browned exteriors.

Convection cooking has the addition of a fan to produce conventional results with a slightly reduced cooking time.

Most conventional recipes will be suitable for use.

Follow the minimum suggested cooking times and add additional time if required.

Convection recipes are also available throughout the recipe section.

### Use of accessories:

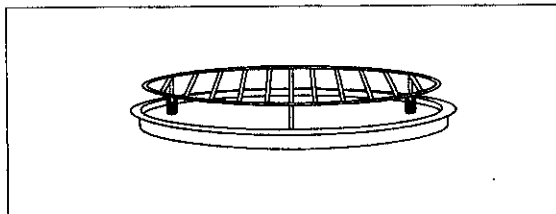

## Two Level Convection:

Two Level Convection is available for when you wish to cook a larger quantity of food.

The entire oven cavity may then be utilized.

For example, cooking two trays of biscuits or two sponge cakes.

Foods placed on the Low Rack may require a slightly longer cooking time than those on the High Rack.

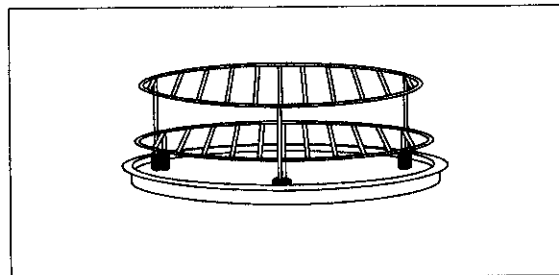

### Use of accessories:

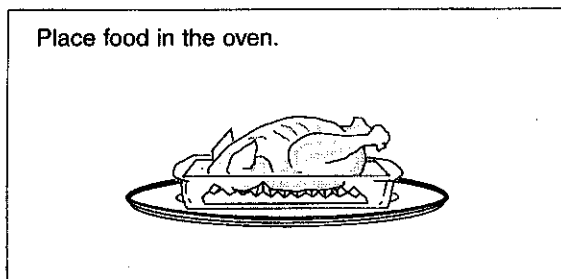

# To Cook on Combination by Time Setting

There are 6 combination setting modes. There is no need to set the temperature or the Micro Power Level.



<b>1</b> Combination 	<ul style="list-style-type: none"> <li>• Select Combination setting. There are 6 settings as below.</li> </ul>
<b>2</b> Time/Weight 	<ul style="list-style-type: none"> <li>• Set cooking time using the Time / Weight Dial. (up to 9 hours and 59 minutes) Time can be entered in 1 min. intervals.</li> </ul>
<b>3</b> Start 	<ul style="list-style-type: none"> <li>• Press.  <ul style="list-style-type: none"> <li>• Cooking starts. The time in the display counts down.</li> </ul> </li> </ul>

Combination cooking is ideal for roasting meats, poultry and cooking cakes, pastries and slices. Combination cooking automatically alternates between Convection and Microwave heating.

The advantage of Combination cooking is that it gives you the browning of Convection and often shortens the conventional cooking time. Time is also reduced as preheating is not required.

To calculate cooking time start by cooking for approximately  $\frac{2}{3}$  of the conventional cooking time and add additional time if required. For examples of recipes and cooking times, consult recipes in the recipe section.

Ovenproof cookware, including glass and ceramic is suitable for use on Combination cooking. Cakes, slices, desserts etc. May be cooked in metal cookware providing there is suitable quantity of food to be absorbed by the microwave heat. For example, do not place a small amount of food in a large metallic dish as arcing may occur.

When cooking by Combination, place dishes to be cooked on the Ceramic Tray.

For crispy jacket potatoes, roast vegetables and chicken pieces place directly on the Low Rack. Sausages and rissoles may also be cooked in this way.

Place a heatproof glass or ceramic dish under the Low Rack to catch any drips from the roast. Alternately, elevate the roast on the roasting rack in a baking dish and place directly on the Ceramic Tray.

## Examples of foods to cook

Combination Setting	Foods Suitable	Oven Temperature	Micro Power Level
COMB 1	casseroles, pot roasts, meat loaves, corned meat	150°C	LOW
COMB 2	quiche, baked custards, rice pudding	160°C	LOW
COMB 3	cakes, self saucing pudding, layered slices, apple pie	170°C	LOW
COMB 4	single layer slices, light cakes, roast lamb	180°C	LOW
COMB 5	roast beef, jacket potato, turkey, duck, garlic bread, chicken piece casseroles, lasagne, reheating sweet/savoury pies, reheating muffins	200°C	MEDIUM-LOW
COMB 6	pastries, bread, grilling sausages and rissoles, whole chicken, chicken pieces, pizzas, reheating croissants	230°C	LOW

## Chart for Convection Baking:

Temperature	Use
100°C	Pavlova
110°C	Meringues
120°C	Slow Drying Herbs
130°C	Large Rich Fruit Cakes, Casseroles
140°C	To start Rich Fruit Cakes(then reduce)
150°C	
160°C	Gingerbread, Biscuits, Shortbread, Small Tarts
170°C	
180°C	Souffle, Stuffed Aubergines
190°C	Lemon Meringue Pie, Mince Pies, Treacle Tarts, Stuffed Chicken, Roulades
200°C	Choux Pastry, Scones, Bread, Sausages Rolls, Vol-au-Vents, Roast Potatoes, Yorkshires
210°C	
220°C	
230°C	
240°C	Some Biscuits eg. Cheese and Almond biscuits
250°C	

## Chart for Combination Cooking:

Item	Combination Setting	Cooking Time
<b>POULTRY</b>		
Chickens (up to 2.8 kg)	6	15 min. / 500 g
Chicken Pieces (1 to 1.5 kg)	6	Approx. $\frac{2}{3}$ conventional cooking time
Turkey (2 to 6 kg)	5	14 min. / 500 g
Duck (1.5 to 2.5 kg)	5	15 to 18 min. / 500 g
<b>BEEF ROASTS</b>		
Rib, Boneless Rib, Top Sirloin		
Rare	5	11 to 14 min. / 500 g
Medium	5	14 to 16 min. / 500 g
Well	5	18 to 20 min. / 500 g
Rump, Eye of Round (High Quality)		
Rare	5	12 to 15 min. / 500 g
Medium	5	13 to 18 min. / 500 g
Well	5	18 to 20 min. / 500 g
Beef Tenderloin		
Rare	5	16 to 18 min. / 500 g
Medium	5	22 to 24 min. / 500 g
Pot Roast (1½ to 2 kg)	1	1½ to 2 hrs. total
Chuck (Turn meat over after 1 hour of cooking)	1	1½ to 2 hrs. total
<b>LAMB ROASTS</b>	4	18 to 20 min. / 500 g
<b>MEATLOAVES</b>	1	25 to 30 min. / 500 g
<b>CASSEROLES</b>	1	Approx. $\frac{2}{3}$ conventional cooking time

# Sensor Reheat /Auto Menu (Sensor Cook, Weight Cook, Auto Cook)

## Sensor Reheat:

This feature allows you to reheat precooked room temperature and refrigerator temperature foods without having to select cooking times and powers. The oven does it automatically.

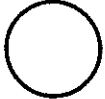

1	Sensor Reheat 	● Press.
2	Start 	● Press. ➤ After the burst of steam is detected by SENSOR, the remaining cooking time appears in the display and begins to count down.

**For best results on Sensor Reheat, follow these recommendations:**

1. Foods weighing less than 125 grams and more than 1 kg should be reheated by power and time only.
2. Do not reheat bread and pastry products. Use manual power and time.
3. Do not use if oven cavity is warm.
4. Do not use for beverages.
5. Do not use for frozen foods.

## Sensor Cook (Auto Menu 1 - 5):

This feature allows you to cook most of your favorite foods without having to select cooking times and powers. The oven does it automatically.

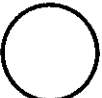
1	Auto Menu 	● Press.
2	Temperature/Menu Select 	● Select desired Category using the Temperature / Menu Select Dial.
3	Start 	● Press. ➤ After the burst of steam is detected by SENSOR, the remaining cooking time appears in the display and begins to count down.

## NOTES:

1. The Auto Sensor system works by detecting a build-up of steam on the sensor. All foods cooked using the Auto Sensor should be covered with a securely fitted lid or plastic wrap. Do not pierce holes on plastic wrap. As foods cook in a microwave oven, steam is produced. After the burst of steam escapes from under the food covering and is detected by the SENSOR, a two beep signal is heard and the oven automatically calculates the remaining cooking time, which counts down in the display window.
2. When a Sensor Reheat/Cook is selected, the oven door should not be opened for longer than one minute. Opening the door may cause inaccurate cooking results. The oven door may be opened to stir, turn or add foods when "STIR" or "TURN OVER" appears in the display window.
3. The room air temperature surrounding the oven should not be above 35°C when using Sensor Reheat/Cook.
4. Foods less than 125 grams should be heated by micro power and time only, not by Sensor Reheat/Cook.
5. When the remaining cooking time is over 60 minutes, the time will appear as hours and minutes.
6. All foods should be taken from their normal storage place.
7. Before using the Sensor Reheat/Cook make sure the Ceramic Tray in the oven is dry to assure best results.
8. Stand time or a power level can be programmed after Sensor Reheat/Cook.
9. If the oven has been previously used on CONVECTION, BAKE, COMBINATION or GRILL, and it is too hot to be used on a Sensor Program, a "HOT" will appear in the display window. The cooling fan will operate to cool the oven rapidly. After the "HOT" disappears, the program may be used. If you are in a hurry, cook food manually i.e. select Micro Power Level and cooking time yourself.

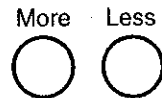

### More/Less Pad:

Preferences for food doneness vary with each individual. After having used Sensor Reheat/Cook a few times, you may decide you would prefer your food cooked to a different doneness. By using the More/Less Pads, the Auto Sensor programs can be adjusted to cook food for a longer or shorter time. Press More/Less Pad after selecting category and before pressing Start Pad.

Press More Pad for more cooking with indication "MORE +"

Press Less Pad for less cooking with indication "LESS -"

If you are satisfied with the result of the Auto Sensor program, you don't have to use this pad.

## SENSOR REHEAT (200 g - 1.2 kg)

- All foods must be pre-cooked.
- Foods should be at room or refrigerated temperatures.
- Stirrable foods are recommended.
- Dish should be covered with plastic wrap or a fitting lid.
- All foods should have a covered stand time of 3 to 5 minutes.
- Do not reheat in foil or plastic containers.

### 1. VEGETABLES (125 g - 1.0 kg)

### 2. ROOT VEGETABLES (125 g - 1.0 kg)

- Vegetables should be trimmed, prepared and cut into even sized pieces.
- Add 1 tablespoon to 1/4 cup of water if vegetables appear slightly dehydrated or a softer texture is desired.
- Place in a suitably sized dish and cover dish with plastic wrap or a fitting lid.
- If desired, butter, herbs, etc. may be added but do not add salt until the completion of cooking.

### 3. FROZEN VEGETABLES (125 g - 1.0 kg)

- Place in a suitably sized dish and cover with plastic wrap or a fitting lid.
- Larger vegetables are placed in a single layer and select a shallow dish for these.
- Add 1 tablespoon to 1/4 cup of water if vegetables appear slightly dehydrated or a softer texture is desired.
- Do not add salt before cooking.
- At the completion of cooking, stir larger quantities and allow to stand for 2 to 3 minutes.





### 4. RICE (100 g · 1/2 cup - 600 g · 3 cup)

- Use a larger sized dish to prevent rice from boiling over.
- Use cold water at a ratio of:  
 1/2 cup rice / 1 cup water  
 1 cup rice / 1 1/2 cups water  
 2 cup rice / 3 cups water
- Cover with plastic wrap or a fitting lid.
- When the cooking time appears in the display window, remove plastic wrap or lid.
- At the completion of cooking, allow 5-10 minutes standing time.

### 5. FISH (250 g - 1.0 kg)

- Suitable for cooking whole fish, fish fillets and cutlets.
- Select fish suitable for microwave cooking and place skin side down in a shallow dish.
- Overlap thin ends of fillets to prevent overcooking.
- Shield the eye and tail area with small amounts of aluminium foil to prevent overcooking.
- For dense pieces of fish, slightly extra cooking time should be allowed by pressing "MORE" pad.

## Weight Cook (Auto Menu 5 - 9)

<p>1 Auto Menu</p> 	<p>• Press.</p>
<p>2 Temperature/Menu Select</p> 	<p>• Select the desired food category using the Temperature / Menu Select Dial.</p>
<p>3 Time/Weight</p> 	<p>• Set the weight using the Time / Weight Dial. Weight can be entered 0.1 Kg intervals.</p>
<p>4 Start</p> 	<p>• Press.              • Cooking time appears in the display and begins to count down.</p>

#### NOTE:

1. Categories "Beef", "Lamb" and "Chicken" are cooked by Combination, and "Meat Skewers" by Grill.
2. When the weight has been entered, the cooking time will be determined.

### 6. BEEF (0.1 kg - 3.0 kg)

- Select roasts that are even in shape, if not, tie roasts with string, to aid with even cooking.
- Place the beef fat side down on the Low Rack, with a shallow dish underneath to collect drips.
- Turn the beef approximately halfway through cooking time.
- At the completion of cooking, wrap in aluminium foil and allow to stand for 10 - 15 minutes before carving.

### 7. LAMB (0.1 kg - 3.0 kg)

- Place the lamb fat side down on the Low Rack with a shallow dish underneath to collect drips.
- Turn the lamb over after approximately halfway through cooking time.
- At the completion of the cooking time, wrap the meat in aluminium foil and allow to stand for 10- 15 minutes before carving.
- Boneless roasts may require an additional 5 - 10 minutes cooking time: Micro Power MEDIUM.



## 8. CHICKEN (0.1 kg - 3.0 kg)

- To keep chicken on shape during cooking, truss or tie the legs of the bird together.
- Place the chicken breast side up on the Low Rack, with a shallow dish underneath to collect the drips.
- There is no need to turn the chicken during the cooking time. If desired, baste the chicken halfway through cooking.
- At the completion of cooking, wrap the chicken in aluminium foil and allow to stand for 10 -15 minutes before carving.

## 9. MEAT SKEWERS (0.1 kg - 1.0 kg)

- Place meat skewers on the High Rack with a shallow dish underneath to collect drips.
- There is no need to turn the meat skewers during the cooking time.
- Cut Meat and Vegetables into even sized pieces.
- Preheating is not required.

### Auto Cook (Auto Menu 10 - 14):

1 Auto Menu 	• Press.
2 Temperature/Menu Select 	• Select desired category using the Temperature / Menu Select Dial.
3 Start 	• Press. • Programmed time appears and begins to count down into the display window.

## 10. COOKIE

- This setting is designed for baking cookies on Convection Bake.
- Metal cookware may be used. Position the tray to be cooked on the High Rack, placed on the Ceramic Tray.
- Preheating is not required.

### Chocolate chip cookie

#### Ingredients:

A: 125 g	softened butter
1/3 cup	brown sugar
1/3 cup	sugar
1/2 cup	chocolate chip
B: 1 1/4 cups	all purpose flour
1/2 tsp.	vanilla extract
1/2 tsp.	baking soda
1/4 tsp.	salt
1	egg

#### Method:

1. Beat the butter together with both kinds of sugar in a mixing bowl until creamy.
2. Add egg into the mixture and beat until smooth. Then add vanilla extract and mix it in.
3. Add flour, salt and baking soda to the mixture at a time. Stir until smooth.
4. Add chocolate chip and mix well.
5. Place spoon small mounds of the dough on a buttered baking tray over High Rack on Ceramic Tray. Leave lots of space between the mounds and transfer onto an attractive serving dish. Select **Cookie** and press **Start Pad**.
6. When cookie is done, invert cookie to cool on a rack and transfer onto an attractive serving dish.

## 11. CAKE

- This setting is designed for baking butter cakes on Convection Bake.
- Metal cookware may be used. Position the dish to be cooked on the Low Rack, placed on the Ceramic Tray.
- Preheating is not required.

### Butter Cakes

#### Ingredients:

150 g self raising flour  
1 tsp. baking powder  
pinch of salt

sifted together

130 g butter  
130 g caster sugar  
240 g (4 no.) eggs, beaten  
1 tbsp. milk  
1 tsp. vanilla essence

#### Method:

1. Line and grease a 20 cm ring cake pan.
2. Cream butter and sugar until fluffy. Gradually beat in eggs and essence.
3. Slowly fold in sifted flour alternating with 1. tbsp. of milk.
4. Place cake pan over Low Rack on Ceramic Tray. Select **Cake** and then **Start Pad**.
5. When cake is done, invert cake to cool on a rack and transfer onto an attractive serving dish.

## 12 - 14. STEW



- This feature is designed for cooking meat/poultry and mixed stews. Suitable for tougher cuts of meat/poultry.
- Place all ingredients liquid in a high microwave safe and heat proof casserole.
- Allow at least 1/2 depth of volume for evaporation to prevent boiling over.
- Cook stew covered.

Food Category	Recommended Food Weight		
	Vegetables	Meat	Liquid
12. Vegetable Stew	600 g	-----	150 ml
13. Meat Stew	-----	1 - 1.5 kg	500 ml
14. Mix Stew	300 g	400 g	150 ml



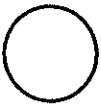

# To Set Timer

This feature allows you to program Standing Time after cooking is completed and to program the oven as a minute timer and/or to program delay start.



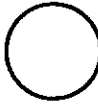

## To Use as a Kitchen Timer:

1	Timer 	● Press.
2	Time/Weight 	● Set desired amount of time using the Time / Weight Dial. (up to 1 hour 30 minutes)
3	Start 	● Press. ☛ Time counts down without operating oven.

## To Set Delay Start:

1	Timer 	● Press.
2	Time/Weight 	● Set desired amount of delay time using the Time / Weight Dial. (up to 1 hour 30 minutes)
3	Micro Power  4 times ↓ Time/Weight 	● Set the desired cooking program. (See page En-7-10 for directions.)
4	Start 	● Press. ☛ Delayed time will count down. Then cooking will start.

## To Set Standing Time:

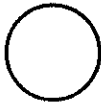
1	e.g. Micro Power  4 times ↓ Time/Weight 	● Set the desired cooking program. (See page En-7-10 for directions.)
2	Timer 	● Press.
3	Time/Weight 	● Set desired amount of Standing Time using the Time / Weight Dial. (up to 1 hour 30 minutes)
4	Start 	● Press. ☛ Cooking will start. After cooking, standing time will count down without operating oven.

### NOTE:

1. If oven door is opened during the Standing Time or Kitchen Timer, the time in the display window will continue to count down.
2. Delay Start cannot be programmed before any Auto Control Function. This is to prevent the standing temperature of the food from rising before defrosting or cooking begins. A change in the starting temperature could cause inaccurate results.







## To Cook using the Recipe Store Pad

This feature allows you to conveniently program into memory.

### To Set Recipe Program:

**Example: To program — 1 minute and 30 seconds at MEDIUM power — into the Recipe Store Pad**

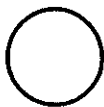
<p>1</p> <p>Recipe Store</p> 	<p>• Press.</p>
<p>2 e.g.</p> <p>Micro Power</p>  <p>4 times</p> <p>↓</p> <p>Time/Weight</p> 	<p>• Set the desired cooking program. (See Page En-7-10 for directions.)</p>
<p>3</p> <p>Recipe Store</p>  <p>or</p> <p>Start</p> 	<p>• Press Recipe Store Pad. If you press Start Pad, cooking starts and cooking program is set.</p> <p>• Time of day or colon appears in the display window.</p>

### To Start Recipe Store Program:

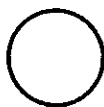
<p>1</p> <p>Recipe Store</p> 	<p>• Press.</p> <p>• The program appears in the display window.</p>
<p>2</p> <p>Start</p> 	<p>• Press.</p> <p>• Cooking time in the display begins to count down.</p>

#### NOTE:



1. Auto Control Functions cannot be programmed into Recipe Store.
2. A new recipe program will cancel the recipe program previously stored.
3. The recipe program will be cancelled if the oven is unplugged.

## To Cook using the Quick Min. Pad

This feature allows you to set cooking times at micro power "HIGH" easily in multiples of one minute.

### To Set Cooking Time:

**Example: To cook at HIGH Power for 5 minutes**

<p>1</p> <p>Quick Min.</p>  <p>5 times</p>	<p>• Set cooking time. (up to 10 minutes)</p> <p>• Cooking time appears in the display window.</p>
<p>2</p> <p>Start</p> 	<p>• Press.</p> <p>• Cooking starts. The time in the display window begins to count down.</p>

#### NOTE:

If you use Quick Min., you cannot use the Time / Weight dial or vice versa.

## To Change the Cooking Time

While operating, you can change the cooking time.

1. Press the Function Pad you set.
2. Change the cooking time to desired amount by using the Time / Weight Dial.

You can change the oven temperature for Convection cooking.

This feature is **not** available for Sensor Reheat or Auto Menu.

# Before Requesting Service

## ALL THESE THINGS ARE NORMAL:

The oven causes interference with my TV.	Some radio and TV interference might occur when you cook with the microwave oven. This interference is similar to the interference caused by small appliances such as mixers, vacuums, hair dryers, etc. It does not indicate a problem with your oven.
Steam accumulates on the oven door and warm air comes from the oven vents.	During cooking, steam and warm air are given off from the food. Most of the steam and warm air are removed from the oven by the air which circulates in the oven cavity. However, some steam will condense on cooler surfaces such as the oven door. This is normal.
I accidentally operate my microwave oven without any food in it.	Operating the oven empty for a short time will not damage the oven. However, we do not recommend this to be done.
There are humming and clicking noises from my oven when I cook by Combination.	These noises occur as the oven automatically switches from microwave power to Convection, to create the Combination setting. This is normal.
The oven has an odor and generates smoke when using the Convection Bake, Combination and Grill function.	It is essential that your oven is wiped out regularly particularly after cooking by Combination or Grill. Any fat and grease that builds up on the roof and walls of the oven will begin to smoke if not cleaned.

### PROBLEM

### POSSIBLE CAUSE

### REMEDY

Oven will not turn on.

The oven is not plugged in securely.

Remove plug from outlet, wait 10 seconds and re-insert.

Circuit breaker or fuse is tripped or blown.

Reset circuit breaker or replace fuse.

There is a problem with the outlet.

Plug another appliance into the outlet to check if the outlet is working.

Oven will not start cooking.

The door is not closed completely.

Close the oven door securely.

Start Pad was not pressed after programming.

Press Start Pad.

Another program has already been entered into the oven.

Press Stop/Reset Pad to cancel the previous program and program again.

The program has not been entered correctly.

Program again according to the Operating Instructions.

Stop/Reset Pad has been pressed accidentally.

Program oven again.

The words "DEMO MODE" appear on the screen.

Clock Pad has been pressed three times.

Deactivate mode by pressing Clock Pad three times.

When the oven is turning on, there is noise coming from Glass Tray.

The roller ring and oven bottom are dirty.

Clean these parts according to care of your oven (See next page).

\* DEMO MODE is designed for retail store display.

Cooking and other functions will not operate during demo mode.

If it seems there is a problem with the oven, contact an authorized Service Centre.

# Care of Your Microwave Oven

1. Turn the oven off and remove the power plug from the wall socket before cleaning.
2. Keep the inside of the oven clean. When food splatters or spilled liquids adhere to oven walls, wipe with a damp cloth. Non caustic oven cleaners may be used if the oven gets very dirty. The use of harsh detergent or abrasives is not recommended.  
**Note:** Do not use oven cleaners on the top of the oven.
3. The outside oven surfaces should be cleaned with a damp cloth. To prevent damage to the operating parts inside the oven, water should not be allowed to seep into the ventilation openings.
4. Do not allow the Control Panel to become wet. Clean with a soft, damp cloth. Do not use detergents, abrasives or spray-on cleaners on the Control Panel.  
When cleaning the Control Panel, leave oven door open to prevent oven from accidentally turning on. After cleaning press STOP/RESET Pad to clear display window.
5. If steam accumulates inside or around the outside of the oven door, wipe with a soft cloth. This may occur when the microwave oven is operated under high humidity conditions and in no way indicates malfunction of the unit.
6. It is occasionally necessary to remove the Ceramic Tray for cleaning. Wash the tray in warm sudsy water or in a dishwasher. If grease accumulates, clean with a nonabrasive nylon mesh scouring pad and non caustic oven cleaners.
7. The roller ring and oven cavity floor should be cleaned regularly to avoid excessive noise. Simply wipe the bottom surface of the oven with mild detergent, water or window cleaner and dry. The roller ring may be washed in mild sudsy water or dish washer. Cooking vapors collect during repeated use but in no way affect the bottom surface or roller ring wheels. When removing the roller ring from cavity floor for cleaning, be sure to replace in the proper position.
8. When using the GRILL or cooking in the COMBINATION mode, some foods may inevitably splatter grease on to the oven walls. If the oven is not cleaned occasionally to eliminate this grease, it can accumulate and cause the oven to "SMOKE" during use. To avoid smoking, run the oven without food and accessories on Grill 1 for 20 minutes.
9. When it becomes necessary to replace the oven light, please consult a dealer to have it replaced.

## Technical Specifications

Power Source:	220 V 50-60Hz	240 V 50 Hz
Power Consumption:		
Microwave	5.9 Amps, 1,220 W	5.3 Amps, 1,220 W
Heater	8.2 Amps, 1,800 W	7.5 Amps, 1,800 W
Output:		
Microwave*	1,000 W	1,000 W
Heater	Approx. 1,800 W	Approx. 1,800 W
Outside Dimensions:	376 (H) x 611 (W) x 501 (D) mm	376 (H) x 611 (W) x 501 (D) mm
Oven Cavity Dimensions:	242 (H) x 412 (W) x 426 (D) mm	242 (H) x 412 (W) x 426 (D) mm
Operating Frequency:	2,450 MHz	2,450 MHz
Uncrated Weight:	21.5 kg	21.5 kg

\* IEC Test Procedure  
Specifications subject to change without notice.  
Voltage requirement may differ by country.

As for the voltage requirement, the production year and month, country and serial number, please refer to the identification plate on the microwave oven.