

Operating Instructions DVD Home Theater Sound System

Model No. **SC-PT570**
SC-PT870

This illustration shows SC-PT570.



Dear customer

Thank you for purchasing this product. For optimum performance and safety, please read these instructions carefully.

**Before connecting, operating or adjusting this product, please read the instructions completely.
Please keep this manual for future reference.**

The illustrations shown may differ from your unit.

Region number

The player plays DVD-Video marked with labels containing the region number "2" or "ALL".

Example:



- These operating instructions are applicable to models SC-PT570 and SC-PT870.
- Unless otherwise indicated, illustrations in these operating instructions are of SC-PT570.
- Operations in these instructions are described mainly with the remote control, but you can perform the operations on the main unit if the controls are the same.

Indicates features applicable to:

PT570 : SC-PT570	PT870 : SC-PT870	
System	SC-PT570	SC-PT870
Main unit	SA-PT570	SA-PT870
Front speakers	SB-HF770	SB-HF770
Center speaker	SB-HC470	SB-HC470
Surround speakers	SB-HS470	SB-HS870
Subwoofer	SB-HW560	SB-HW560

CAUTION!

THIS PRODUCT UTILIZES A LASER.
USE OF CONTROLS OR ADJUSTMENTS OR PERFORMANCE OF PROCEDURES OTHER THAN THOSE SPECIFIED HEREIN MAY RESULT IN HAZARDOUS RADIATION EXPOSURE.
DO NOT OPEN COVERS AND DO NOT REPAIR YOURSELF. REFER SERVICING TO QUALIFIED PERSONNEL.

WARNING:

TO REDUCE THE RISK OF FIRE, ELECTRIC SHOCK OR PRODUCT DAMAGE,

- DO NOT EXPOSE THIS APPARATUS TO RAIN, MOISTURE, DRIPPING OR SPLASHING AND THAT NO OBJECTS FILLED WITH LIQUIDS, SUCH AS VASES, SHALL BE PLACED ON THE APPARATUS.
- USE ONLY THE RECOMMENDED ACCESSORIES.
- DO NOT REMOVE THE COVER (OR BACK); THERE ARE NO USER SERVICEABLE PARTS INSIDE. REFER SERVICING TO QUALIFIED SERVICE PERSONNEL.

CAUTION!

- DO NOT INSTALL OR PLACE THIS UNIT IN A BOOKCASE, BUILT-IN CABINET OR IN ANOTHER CONFINED SPACE. ENSURE THE UNIT IS WELL VENTILATED. TO PREVENT RISK OF ELECTRIC SHOCK OR FIRE HAZARD DUE TO OVERHEATING, ENSURE THAT CURTAINS AND ANY OTHER MATERIALS DO NOT OBSTRUCT THE VENTILATION VENTS.
- DO NOT OBSTRUCT THE UNIT'S VENTILATION OPENINGS WITH NEWSPAPERS, TABLECLOTHS, CURTAINS, AND SIMILAR ITEMS.
- DO NOT PLACE SOURCES OF NAKED FLAMES, SUCH AS LIGHTED CANDLES, ON THE UNIT.
- DISPOSE OF BATTERIES IN AN ENVIRONMENTALLY FRIENDLY MANNER.

This product may receive radio interference caused by mobile telephones during use. If such interference is apparent, please increase separation between the product and the mobile telephone.

The socket outlet shall be installed near the equipment and easily accessible.
 The mains plug of the power supply cord shall remain readily operable.
 To completely disconnect this apparatus from the AC Mains, disconnect the power supply cord plug from AC receptacle.

THIS UNIT IS INTENDED FOR USE IN MODERATE CLIMATES.



(Side of product)

CAUTION	- LASER RADIATION WHEN OPEN. DO NOT STARE INTO BEAM. FDA 21 CFR / Class
CAUTION	- CLASS 1M VISIBLE AND INVISIBLE LASER RADIATION WHEN OPEN. DO NOT VIEW DIRECTLY WITH OPTICAL INSTRUMENTS. IEC60825-1+A21 Class 1M.
WARNING	- KLASSE 1M SYNLIG OCH OSYNLIG LASERSTRÅLNING NÄR DENNA DEL ÄR ÖPPNAD. BETRÄKTA EJ STRÅLEN DIREKT GENOM OPTISKT INSTRUMENT.
FORSIGTIG	- SYNLIG OG USYNLIG LASERSTRÅLING KLASSE 1M. NÄR LÅGET ER ÅBENT, UNDGÅ AT SE UDGE PÅ MED OPTISKE INSTRUMENTER.
VARO!	- AVATTAESSA OLET ALTIINA LUOKAN 1M NÄKYVÄÄ JA NÄKYMÄTÖNTÄ LASERISÄTELYÄ. ÄLÄ KATSO OPTISELLÄ LAITTEELLA SUORAAN SÄTEESEEN.
VORSICHT	- SICHTBARE UND UNSICHTBARE LASERSTRÄHLUNG KLASSE 1M. WENN ABDECKUNG GEÖFFNET, NICHT DIREKT MIT OPTISCHEN INSTRUMENTEN BETRACHTEN.
ATTENTION	- RAYONNEMENT LASER VISIBLE ET INVISIBLE, CLASSE 1M EN CAS D'OUVERTURE. NE PAS REGARDER DIRECTEMENT À L'ŒIL DES INSTRUMENTS D'OPTIQUE.
注意	- ここを覗くと可視及び不可視レーザー光が出ます。ヒームを見たり、覗いたりしないでください。
注意	- 打用時有可能見及不可見激光辐射。避免光照射。 GB7241, 1-20010B 类 ROLX50075

(Inside of product)

Accessories

Please check and identify the supplied accessories.



- 1 Remote control (N2QAYB000361)



- 2 Remote control batteries



- 1 FM indoor antenna



- PT570** 3 Speaker cables
- PT870** 1 Speaker cable



- 1 AC mains lead



- 1 Sheet of speaker cable stickers



- PT570** 2 Speaker stands (with cable)
- PT870** 4 Speaker stands (with cable)



- PT570** 2 Bases
- PT870** 4 Bases



- PT570** 8 Screws
- PT870** 16 Screws



- 1 Auto speaker setup microphone



TABLE OF CONTENTS

Getting Started

Accessories	2
-------------------	---

Quick Start Guide

step 1 Assembling the speakers	4
step 2 Positioning	5
step 3 Connections	6
Speaker connections	6
Radio antenna connections	6
Audio and video connections	7
step 4 AC mains lead connection	8
step 5 Preparing the remote control	8
step 6 SMART SETUP	9

Setting up the radio	10
Presetting stations automatically	10
Confirming the preset channels	10
Manual tuning	10
RDS broadcasting	11
Selecting the playback source	11
Selecting the source from the START menu	11
Selecting the source by the remote control	12

Enjoying sound from all speakers and various sound effects

Enjoying surround sound effects	12
Selecting sound mode	13
Whisper-mode Surround	13
Adjusting the speaker output level manually	13

Playing Discs

Basic play	14
Using the main unit	14
Using the remote control	15
Other modes of play	16
Repeat play	16
Program and Random play	16

Using navigation menus	17
Playing data discs	17
Playing RAM and DVD-R/-RW (DVD-VR) discs	17
Using on-screen menus	18

Other Operations

Using the VIERA Link "HDAVI Control™"	20
One touch play	20
Auto input switching	20
Power off link	20
Speaker control	20
VIERA Link Control only with TV's remote control (for "HDAVI Control 2 or later")	21

Operating other devices	21
Playing from an USB device	21
Using the iPod	22

Reference

Speaker installation option	23
Changing the player settings	24
DivX information	26
Displaying DivX subtitles text	26
Safety precautions	27
Discs that can be played	28
Maintenance	29

Troubleshooting guide	30
Specifications	32
Glossary	33
Control reference guide	34

step 1 | Assembling the speakers

PT570 Front speaker

PT870 Front and surround speakers

Preparation

- To prevent damage or scratches, lay down a soft cloth and perform assembly on it.
- For assembly, use a Phillips-head screwdriver (not included).

Make sure you have all the indicated components before starting assembly, setup, and connection.

- Keep the screws out of reach of children to prevent swallowing.
- For optional wall mount, refer to page 23.



PT570
2 Front speakers

PT870
2 Front speakers
2 Surround speakers



PT570
2 Stands (with cable)

PT870
4 Stands (with cable)

PT570 2 Bases
PT870 4 Bases

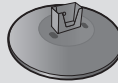

PT570 8 Screws
PT870 16 Screws

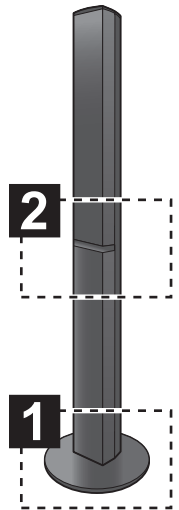
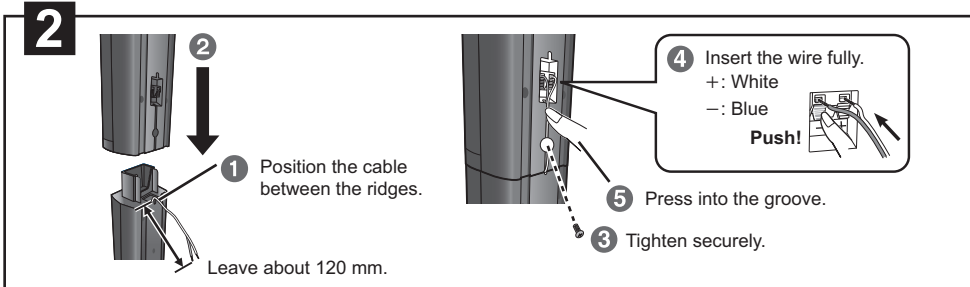
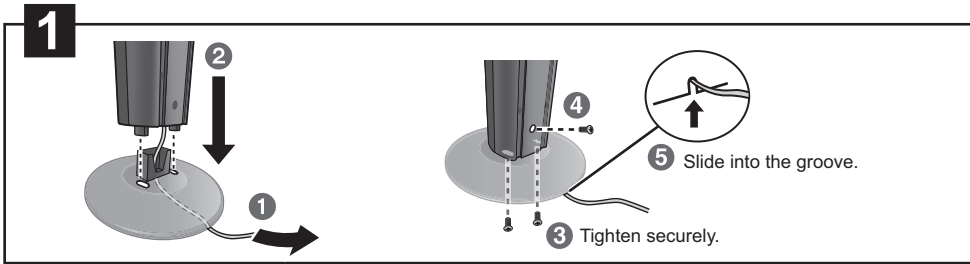

Speaker assembly option

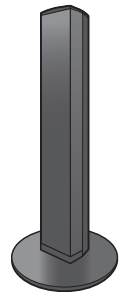
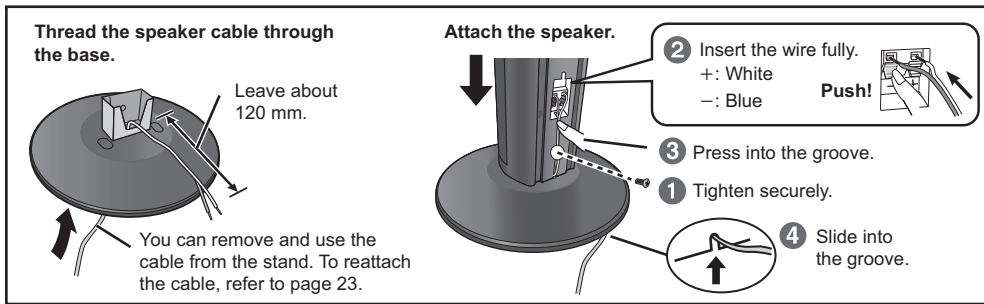

Preventing the speakers from falling

- You will need to obtain the appropriate screw eyes to match the walls or pillars to which they are going to be fastened.
- Consult a qualified housing contractor concerning the appropriate procedure when attaching to a concrete wall or a surface that may not have strong enough support. Improper attachment may result in damage to the wall or speakers.

e.g. Front speaker

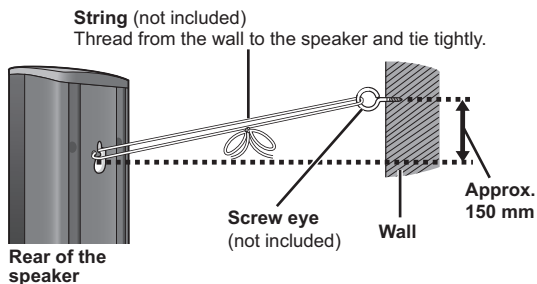

Caution

Do not stand on the base. Be cautious when children are near.

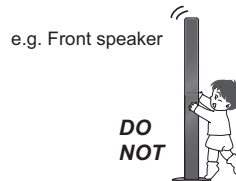

step 2 | Positioning

How you set up your speakers can affect the bass and the sound field.

Note the following points:

- Place speakers on flat secure bases.
- Placing speakers too close to floors, walls, and corners can result in excessive bass. Cover walls and windows with thick curtains.

Note

Keep your speakers at least 10 mm away from the system for proper ventilation.

Setup example

Place the front, center, and surround speakers at approximately the same distance from the seating position. Using "Auto speaker setup" (→ 9) is a convenient way to get the ideal surround sound from your speakers when you are unable to place them. The angles in the diagram are approximate.

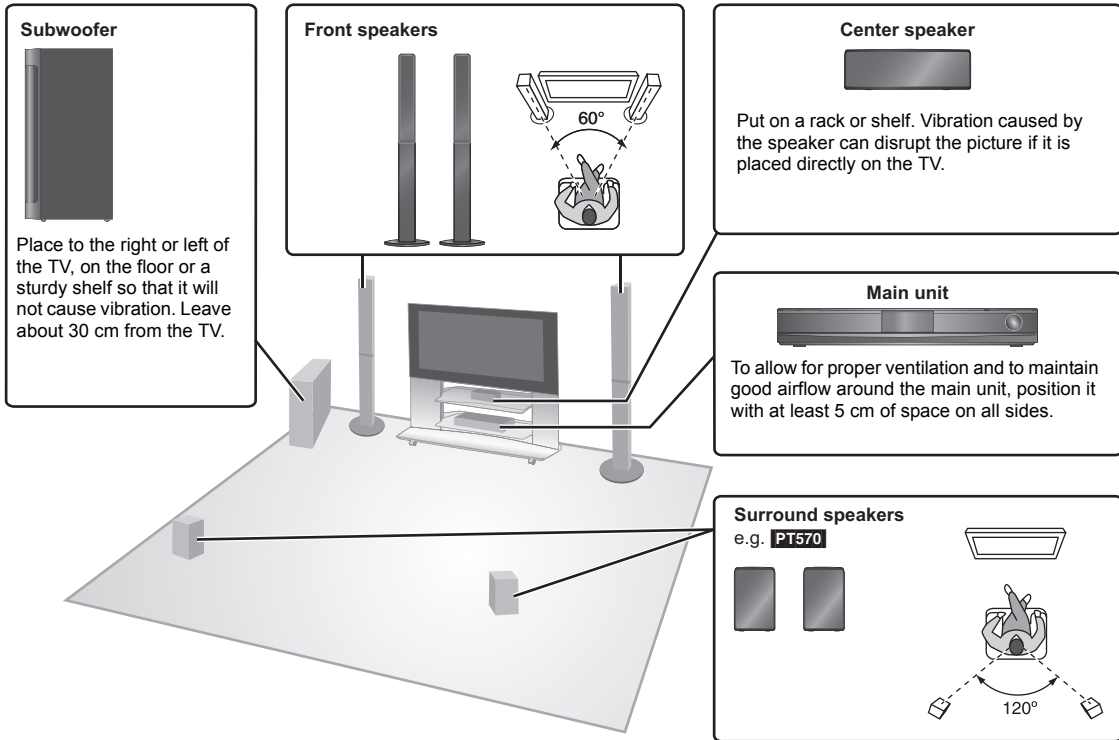

Caution

Do not touch the front netted area of the speakers. Hold by the sides.

e.g. Center speaker



If irregular colouring occurs on your TV

The center speaker is designed to be used close to a TV, but the picture may be affected with some TVs and setup combinations.

If this occurs, turn the TV off for about 30 minutes.

The demagnetising function of the TV should correct the problem. If it persists, move the speakers further away from the TV.



Set your surround sound free! Optional Panasonic wireless accessory (example: SH-FX70)

You can enjoy surround speaker sound wirelessly when you use the optional Panasonic wireless accessory (example: SH-FX70).

For details, please refer to the operating instructions for the optional Panasonic wireless accessory.

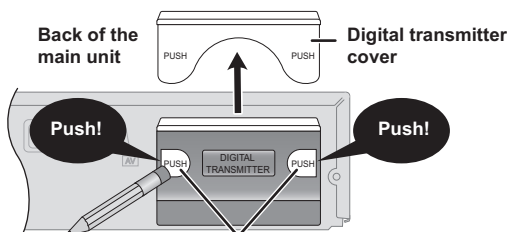

You can use the blunt end of a writing instrument to push here until the cover pops out.

- Remove the digital transmitter cover before installing any optional Panasonic wireless accessory.
- Replace the cover when the digital transmitter is not in use.

Caution

- The main unit and supplied speakers are to be used only as indicated in this setup. Failure to do so may lead to damage to the amplifier and/or the speakers, and may result in the risk of fire. Consult a qualified service person if damage has occurred or if you experience a sudden change in performance.
- Do not attempt to attach these speakers to walls using methods other than those described in this manual.

Notes on speaker use

- Use only supplied speakers
Using other speakers can damage the unit, and sound quality will be negatively affected.
- You can damage your speakers and shorten their useful life if you play sound at high levels over extended periods.
- Reduce the volume in the following cases to avoid damage:
 - When playing distorted sound.
 - When the speakers are reverberating due to a record player, noise from FM broadcasts, or continuous signals from an oscillator, test disc, or electronic instrument.
 - When adjusting the sound quality.
 - When turning the unit on or off.

step 3 | Connections

Turn off all equipment before connection and read the appropriate operating instructions.
Do not connect the AC mains lead until all other connections are complete.

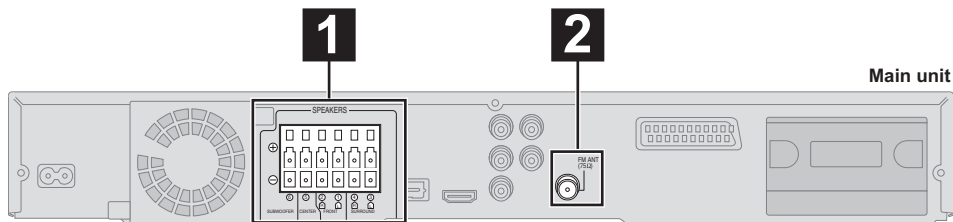

1 Speaker connections

Setup example

Pay attention to the type of speaker and the connector colour when you place the speakers.
Connect to the terminals of the same colour.

Use of the speaker cable stickers is convenient when making cable connections.

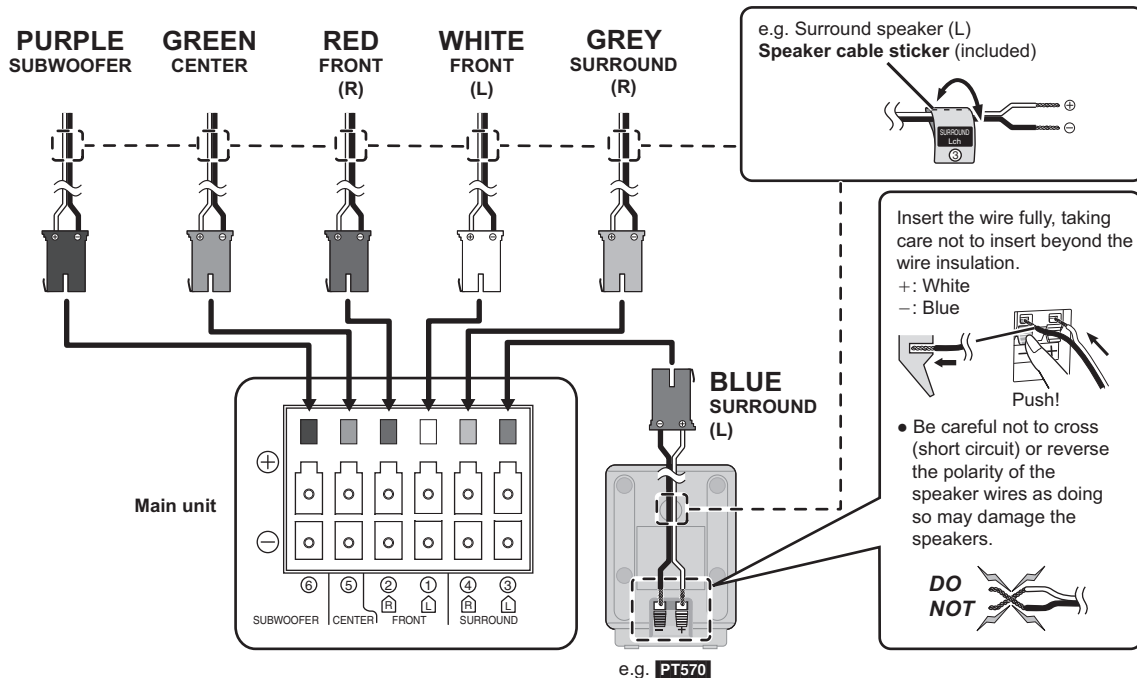

2 Radio antenna connections

Using an indoor antenna

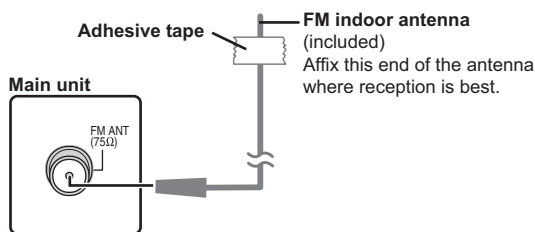

Using an outdoor antenna

Use outdoor antenna if FM radio reception is poor.
• Disconnect the antenna when the unit is not in use.
• Do not use the outdoor antenna during an electrical storm.

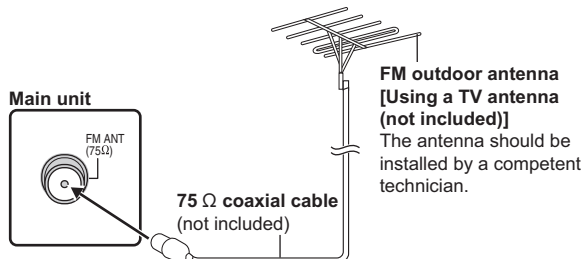

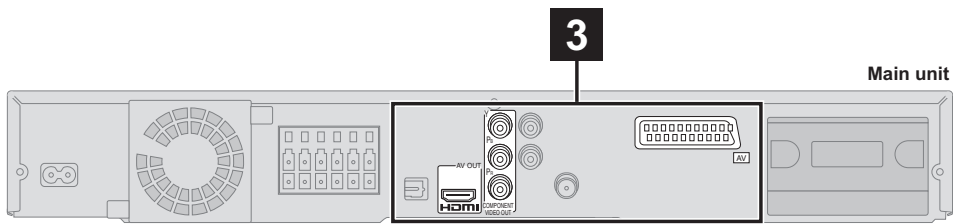

3 Audio and video connections

Basic setup example

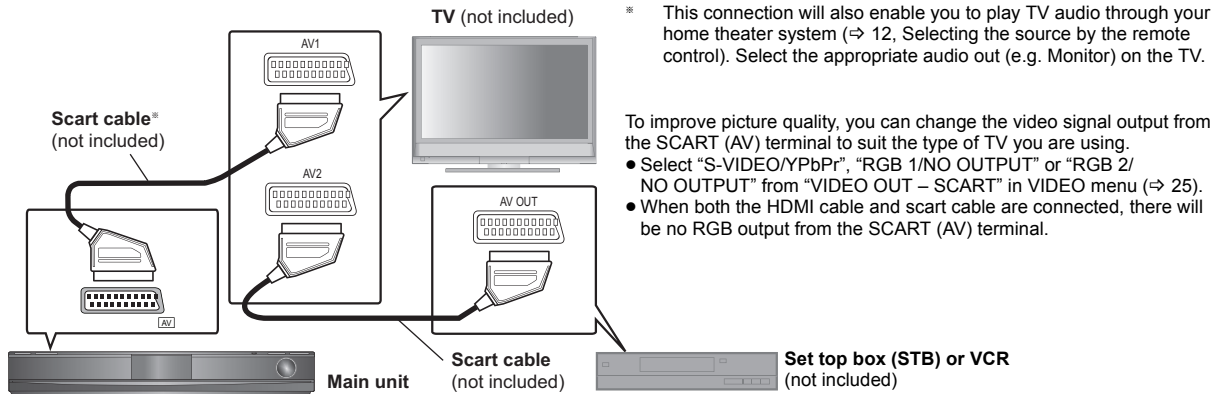

Other video connections

TV terminal	Cable required (not included)	Main unit terminal	Features
<p>Note If there is more than one HDMI terminal, refer to the operating instructions for the TV to determine terminal to connect to.</p>	<p>HDMI cable</p> <p>Note</p> <ul style="list-style-type: none"> • Non-HDMI-compliant cables cannot be utilized. • It is recommended that you use Panasonic's HDMI cable. Recommended part number: RP-CDHG15 (1.5 m), RP-CDHG30 (3.0 m), RP-CDHG50 (5.0 m), etc. 		<p>This connection provides the best picture quality.</p> <ul style="list-style-type: none"> • Set "VIDEO PRIORITY" to "ON" (⇒ 25, HDMI menu). • Set "VIDEO FORMAT" in Menu 4 (HDMI) (⇒ 19). <p>VIERA Link "HDAVI Control"</p> <p>If your Panasonic TV is VIERA Link compatible, you can operate your TV synchronising with home theater operations or vice versa (⇒ 20, Using the VIERA Link "HDAVI Control™").</p> <ul style="list-style-type: none"> • Make the extra audio connection (⇒ 8) when you use VIERA Link "HDAVI Control" function.
<p>Panasonic TVs with 576/50i-50p, 480/60i-60p input terminals are progressive compatible. Consult the manufacturer if you have another brand of TV.</p>	<p>Video cables</p>	<ul style="list-style-type: none"> • Connect to terminals of the same colour. 	<p>This connection provides a much purer picture than the SCART (AV) terminal.</p> <ul style="list-style-type: none"> • When making this connection, select "VIDEO/YPbPr" or "S-VIDEO/YPbPr" in "VIDEO OUT – SCART" in VIDEO menu. If "RGB 1/NO OUTPUT" or "RGB 2/NO OUTPUT" is selected, no signal is output from the component video terminals. (⇒ 25) <p>To enjoy progressive video</p> <ul style="list-style-type: none"> • Connect to a progressive output compatible TV. <ul style="list-style-type: none"> – Set "VIDEO OUT (I/P)" in VIDEO menu to "PROGRESSIVE" and then follow the instructions on the menu screen (⇒ 25).

Note

- Do not make the video connections through the VCR. Due to copy guard protection, the picture may not be displayed properly.
- Only one video connection is required. Choose one of the video connections above depending on your TV.

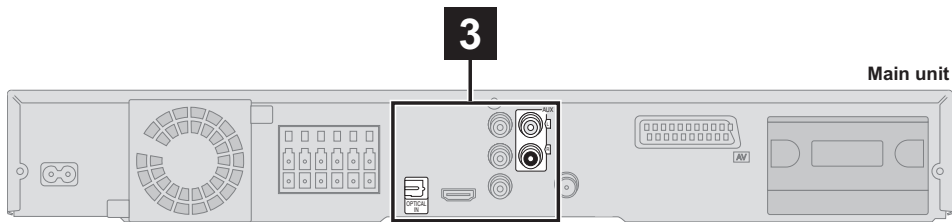

Main unit

3 Audio and video connections (continued)

Other audio connections

TV or external equipment terminal	Cable required (not included)	Main unit terminal	Features
 OPTICAL OUT	<ul style="list-style-type: none"> Do not bend sharply when connecting. <p>Optical digital audio cable</p>	 OPTICAL IN	<p>This is the preferred connection for best sound and true surround sound.</p> <p>This unit can decode the surround signals received from your TV, cable or satellite STB. Refer to the operating instructions for the TV, cable or satellite STB for the settings necessary to output its audio from the digital audio output to your home theater system. Only Dolby Digital and PCM can be played with this connection.</p> <ul style="list-style-type: none"> After making this connection, make settings to suit the type of audio from your digital equipment (⇒ 12).
 AUDIO OUT L R	<p>Audio cable</p>	 AUX	<p>This connection enables you to play audio from your TV, STB or VCR through your home theater system (⇒ 12, Selecting the source by the remote control).</p>

Note

If you have various sound sources (such as Blu-ray player, DVD recorder, VCR, etc.), connect them to the available inputs on the TV and the TV output should then be connected to the AUX or OPTICAL IN terminal of the main unit.

step 4 AC mains lead connection

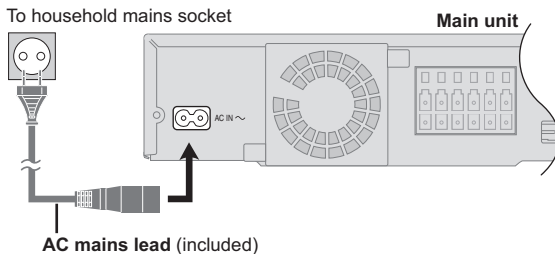

Conserving power

The main unit consumes a small amount of power, even when it is in standby mode (approx. 0.2 W). To save power when the unit is not to be used for a long time, unplug it from the household AC mains socket. You will need to reset some memory items after plugging in the main unit.

Note

The included AC mains lead is for use with the main unit only. Do not use it with other equipment. Also, do not use cords for other equipment with the main unit.

step 5 Preparing the remote control

Batteries

- Insert so the poles (+ and -) match those in the remote control.

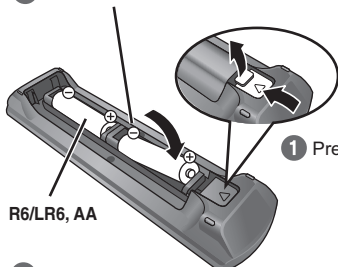

R6/LR6, AA

- Replace the cover.

CAUTION

Danger of explosion if battery is incorrectly replaced. Replace only with the same or equivalent type recommended by the manufacturer. Dispose of used batteries according to the manufacturer's instructions.

- Use alkaline or manganese batteries.
- Do not heat or expose to flame.
- Do not leave the battery(ies) in an automobile exposed to direct sunlight for a long period of time with doors and windows closed.

Do not:

- mix old and new batteries.
 - use different types at the same time.
 - take apart or short circuit.
 - attempt to recharge alkaline or manganese batteries.
 - use batteries if the covering has been peeled off.
- Mishandling of batteries can cause electrolyte leakage which can severely damage the remote control.

Remove the batteries if the remote control is not going to be used for a long period of time. Store in a cool, dark place.

Use

Aim at the remote control signal sensor (⇒ 35), avoiding obstacles, at a maximum range of 7 m directly in front of the unit.

The Smart setup screen assists you to make necessary settings.

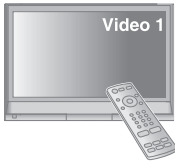

Preparation

Turn on your TV and select the appropriate video input mode (e.g. VIDEO 1, AV 1, HDMI, etc.) to suit the connections to this unit.

- To change your TV's video input mode, refer to its operating instructions.
- This remote control can perform some basic TV operations (⇒ 34).

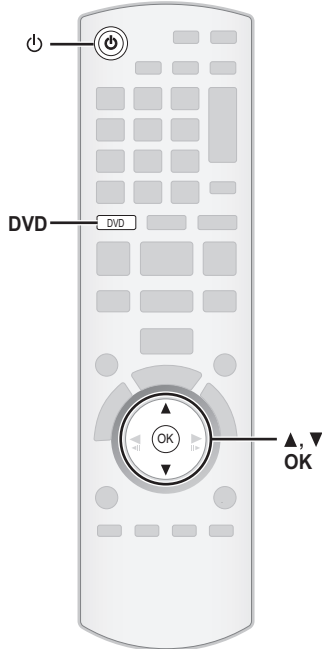

1		<p>Turn on the unit.</p> <ul style="list-style-type: none"> • When the Smart setup screen appears automatically, skip step 2 and 3.
2		<p>Select "DVD/CD".</p>
3	 (Main unit only)	<p>Show the Smart setup.</p> <div style="border: 1px solid black; padding: 5px; width: fit-content; margin: 0 auto;"> <p>Smart setup</p> <p>Would you like to start smart setup?</p> <p style="text-align: center;">Yes No</p> <p style="text-align: center;"></p> </div>
4		<p>Select "Yes".</p>
5		<p>Follow the messages and make the settings. (⇒ right, Smart setup settings)</p>
6		<p>Finish Smart setup.</p>

Smart setup settings

- **Language**
Select the language used on menu screen.
- **TV aspect**
Select the aspect to suit your TV.
- **Video out**
Choose the video signal format to be output from SCART (AV) and COMPONENT VIDEO OUT terminals.
- **Speaker check**
Listen to speaker output to confirm speaker connections.
- **Auto speaker setup**
Adjust the speaker output level automatically. (⇒ below)
- **Speaker output**
Make surround sound setting for speaker output.
- **TV audio**
Select the audio input connection from your TV.
For AUX connection (⇒ 8): Select "AUX".
For OPTICAL IN connection (⇒ 8): Select "DIGITAL IN".
This will be the TV audio setting for VIERA Link "HDAVI Control". (⇒ 20)

Note

- If this unit is connected to a "HDAVI Control 3 or later" compatible TV via HDMI cable, the menu language and TV aspect information will be retrieved via VIERA Link.
- If this unit is connected to a "HDAVI Control 2" compatible TV via HDMI cable, the menu language information will be retrieved via VIERA Link.
- Settings in the Smart setup can also be changed in the player settings [e.g. language, TV aspect, speaker level and TV audio (⇒ 24)].

Adjusting the speaker output level automatically: Auto speaker setup

The speaker level settings can be optimized to accommodate your room's listening conditions so that you can enjoy the ideal surround sound experience.

Keep as quiet as possible during the Auto speaker setup. Loud voices, air-conditioning noise, or excessive wind may lead to incorrect settings. The speakers output loud test signals during setup.

- Place the Auto speaker setup microphone at actual seating position. (At ear level when seated.)
- The test signal is output from each speaker.

e.g. **PT570**

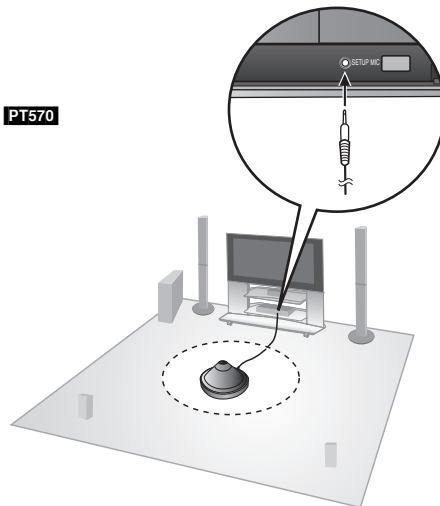

Note

Auto speaker setup can be activated through Smart setup only.

Setting up the radio

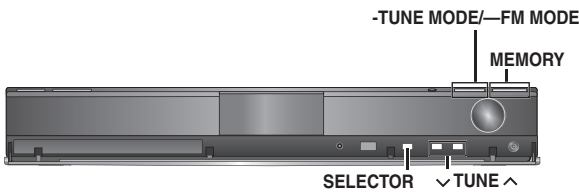
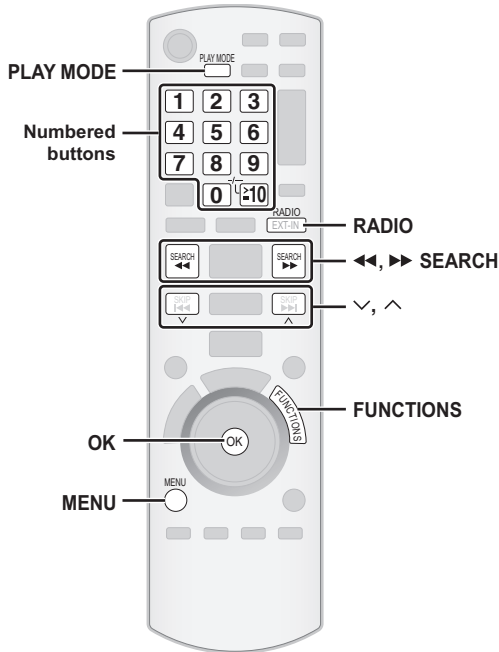

Confirming the preset channels

1		Select "FM". <ul style="list-style-type: none"> • Main unit: Press [SELECTOR].
2		Select the channel. <ul style="list-style-type: none"> • To select a 2-digit number e.g. 12: [≥10] ⇒ [1] ⇒ [2] <div style="border: 1px solid black; padding: 5px; width: fit-content; margin: 5px auto;"> </div> <p>Alternatively, press [v, ^].</p> <ul style="list-style-type: none"> • Main unit: Press [-TUNE MODE] to select "PRESET" on the display, and then press [v TUNE ^] to select the channel. <p>When a stereo FM broadcast is being received, "ST" lights in the display.</p> <div style="border: 1px solid black; padding: 5px; width: fit-content; margin: 5px auto;"> </div>

• The FM setting is also shown on the TV display.

If noise is excessive

Press and hold [PLAY MODE] (main unit: [-FM MODE]) to display "MONO".

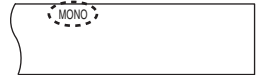

Press and hold the button again to cancel the mode.

• The mode is also cancelled when you change the frequency.

Presetting stations automatically

Up to 30 stations can be set.

1		Select "FM". <ul style="list-style-type: none"> • Main unit: Press [SELECTOR].
2		<p>Each time you press the button: LOWEST (factory preset): To begin auto preset with the lowest frequency.</p> <p>CURRENT: To begin auto preset with the current frequency.*</p> <p>* To change the frequency, refer "Manual tuning" (⇒ right).</p>
3	<p>(press and hold)</p>	<p>Release the button when "FM AUTO" is displayed.</p> <div style="border: 1px solid black; padding: 5px; width: fit-content; margin: 5px auto;"> </div> <ul style="list-style-type: none"> • Main unit: Press and hold [MEMORY]. <p>The tuner starts to preset all the stations it can receive into the channels in ascending order.</p>

• "SET OK" is displayed when the stations are set, and the radio tunes to the last preset station.

• "ERROR" is displayed when automatic presetting is unsuccessful. Preset the channels manually (⇒ 11).

Manual tuning

1		Select "FM". <ul style="list-style-type: none"> • Main unit: Press [SELECTOR].
2		Select the frequency. <ul style="list-style-type: none"> • Main unit: Press [-TUNE MODE] to select "MANUAL" on the display, and then press [v TUNE ^] to select the frequency. • To start automatic tuning, press and hold [◀▶] (main unit: [v TUNE ^]) until the frequency starts scrolling. Tuning stops when a station is found.

Presetting stations manually

Up to 30 stations can be set.

- ① While listening to the radio broadcast
Press **[OK]**.
- ② While the frequency is flashing on the display
Press the numbered buttons to select a channel.
 - To select a 2-digit number
e.g. 12: [≥10] ⇒ [1] ⇒ [2]

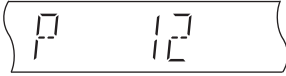

Alternatively, press [v, ^], and then press [OK].

Main unit:

- ① While listening to the radio broadcast
Press **[MEMORY]** twice.
- ② While a channel number is flashing on the display
Press [v TUNE ^], and then press **[MEMORY]**.

A station previously stored is overwritten when another station is stored in the same channel preset.

RDS broadcasting

The unit can display the text data transmitted by the radio data system (RDS) available in some areas.
If the station you are listening to is transmitting RDS signals, "RDS" will light up on the display.

While listening to the radio broadcast
Press **[FUNCTIONS]** to display the text data.

Each time you press the button:

PS: Program service

PTY: Program type

FREQ: Frequency display

PTY displays			
NEWS	VARIED	FINANCE	COUNTRY
AFFAIRS	POP M	CHILDREN	NATIONAL
INFO	ROCK M	SOCIAL A	OLDIES
SPORT	M-O-R- M*	RELIGION	FOLK M
EDUCATE	LIGHT M	PHONE IN	DOCUMENT
DRAMA	CLASSICS	TRAVEL	TEST
CULTURE	OTHER M	LEISURE	ALARM
SCIENCE	WEATHER	JAZZ	

*"M-O-R- M"=Middle of the road music

Note

RDS displays may not be available if reception is poor.

Selecting the playback source

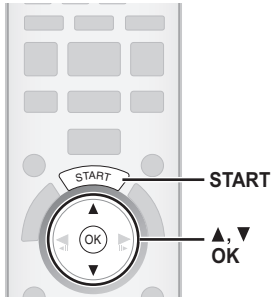

When "Input Selection" is selected

You can select a desired source from the menu.

- DVD/CD (⇒ 9), FM (⇒ 10), AV (⇒ 12), AUX* (⇒ 12), DIGITAL IN* (⇒ 12), USB (⇒ 21), iPod (⇒ 22)

* "(TV)" will appear beside "AUX" or "DIGITAL IN", indicating the TV audio setting for VIERA Link "HDAVI Control" (⇒ 20).

When "Sound" is selected

You can select sound quality settings (⇒ 13, Equalizer).

When a disc is loaded or an USB device is connected, you can also access playback or menus from the START menu.

e.g. **[DVD-V]**

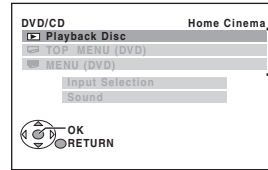

Playback/menu access

When the on-screen control panel appears

e.g. **[DVD-V]** (when "Playback Disc" is selected from the START menu)

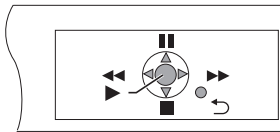

You can operate the playback with the indicated controls.

(Continued on next page)

Selecting the source from the START menu

You can select sound effects, desired source, or access playback/menus by using the START menu.

1



Show the START menu.

This unit automatically turns on. (The TV also turns on when using VIERA Link "HDAVI Control". This works only when in "DVD/CD", "USB" or "IPOD" mode without any disc/device being loaded/connected.)
e.g.

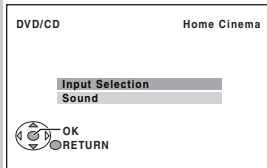

2



Select an item.

- To exit, press [START].

3



Make the setting.

Selecting the playback source (continued)

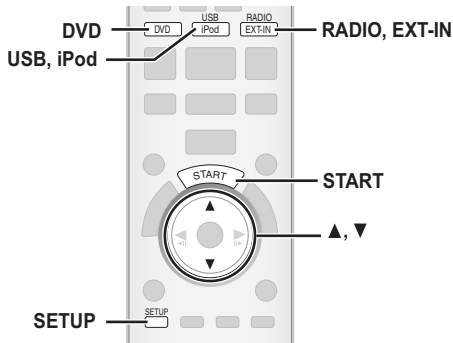

Press [SELECTOR] on the main unit to select source from the main unit. (⇒ 35)

Note

Confirm the audio connection to the SCART (AV), AUX or OPTICAL IN terminal on the main unit when you select the corresponding sources (⇒ 7). Reduce the volume on the TV to its minimum, and then adjust the volume of the main unit.

Making settings for digital audio input

Select to suit the type of audio from the OPTICAL IN terminal on the main unit.

- 1 While in "D-IN" mode
Press [SETUP] to select "MAIN/SAP", "DRC" or "PCM FIX".
- 2 While the selected mode is displayed
Press [▲, ▼] to make the setting.

MAIN/SAP mode (Only works with Dolby Dual Mono):

MAIN, SAP*, **MAIN+SAP*** (stereo audio)
* "SAP" = Secondary Audio Program

Dynamic Range Compression

DRC ON: Adjust for clarity even when the volume is low by compressing the range of the lowest sound level and the highest sound level. Convenient for late night viewing. (Only works with Dolby Digital)

DRC OFF: The full dynamic range of the signal is reproduced.

PCM FIX mode

PCM ON: Select when receiving only PCM signals.

PCM OFF: Select when receiving Dolby Digital and PCM signals.

(When receiving true 5.1-channel surround sound, select "PCM OFF".)

Note

- Audio that is input through the OPTICAL IN terminal is not output from the HDMI terminal.
- Underlined items in the above are factory settings.

Selecting the source by the remote control

	DVD/CD (⇒ 9)
	Each time you press the button: FM (⇒ 10) AV: For audio input through the SCART (AV) terminal. AUX*: For audio input through the AUX terminal. D-IN*: For audio input through the OPTICAL IN terminal. (⇒ right) * "(TV)" will appear beside "AUX" or "D-IN", indicating the TV audio setting for VIERA Link "HDAVI Control" (⇒ 20).
	USB (⇒ 21) iPod (⇒ 22)

Enjoying sound from all speakers and various sound effects

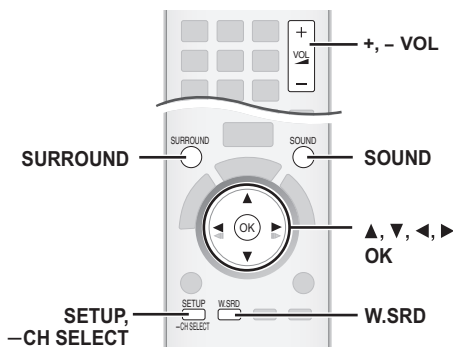

- The following sound effects may not be available or have no effect with some sources, or when headphones are used (⇒ 35).
- You may experience a reduction in sound quality when these sound effects are used with some sources. If this occurs, turn the sound effects off.

Enjoying surround sound effects



SURROUND OUTPUT indicator on the main unit will light up when there is surround sound effect.

Each time you press the button:

STANDARD:
Sound is output as it was recorded/encoded. Speaker output varies depending on the source.

MULTI-CH:
You can enjoy sound from the front speakers, as well as the surround speakers even when playing a 2-channel sound or non-surround sound.

MANUAL: (⇒ right)

While "MANUAL" is displayed



Select other surround modes.

Each time you press [◀, ▶]:

PLII MOVIE*
Suitable for movie software, or the one recorded in Dolby Surround. (except **DivX**)

PLII MUSIC*
Adds 5.1-channel effects to stereo sources. (except **DivX**)

S.SRND

You can enjoy sound from all speakers with stereo sources. (Surround output will be in mono.)

STEREO

Sound will be output to the front speakers and the subwoofer only for any source.

* "□□PLII" lights in the main unit's display when there is effect.

Recommended modes to enjoy TV audio or stereo sources from all speakers:

- PLII MOVIE
- PLII MUSIC
- S.SRND

Selecting sound mode

- 

Select a sound mode.
Each time you press the button:
EQ: Equalizer
SUBW LVL: Subwoofer Level
C.FOCUS: Center Focus
- While the selected mode is displayed**



Make settings.
Refer to the followings for setting details of each sound effect.

Equalizer

You can select sound quality settings.

Each time you press [**◀**, **▶**]:

HEAVY: Adds punch to rock.

CLEAR: Clarifies higher sounds.

SOFT: For background music.

FLAT: Cancel (no effect is added).

Subwoofer level

You can adjust the amount of bass. The unit automatically selects the most suitable setting according to the type of playback source.

SUB W 1 ↔ SUB W 2 ↔ SUB W 3 ↔ SUB W 4

- The setting you make is retained, and recalled every time you play the same type of source.

Center Focus

(Effective when playing audio containing center channel sound or when "DOLBY" lights in the main unit display.)



You can make the sound of the center speaker seem like it is coming from within the TV.

C.FOCUS ON ↔ C.FOCUS OFF

Whisper-mode Surround

Except **DivX**

You can enhance the surround effect for low volume 5.1-channel sound. (Convenient for late night viewing.)

- 
- "(())" lights when there is effect.
- 
- Each time you press the button:
WHISPER-MODE SRD ON
↓
WHISPER-MODE SRD OFF

Adjusting the speaker output level manually

Preparation

- To display the picture, turn on the TV and select the appropriate video input mode.
- Press [**+**, **-** VOL] to adjust the volume to normal listening level.
- Select "TEST TONE" from "SPEAKER SETTINGS" in AUDIO menu (⇒ 25).

- 

Enter test tone mode.

e.g.

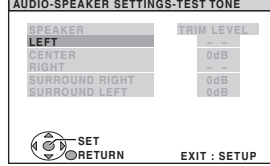

Test tone will be output to each channel in the following order.
LEFT, CENTER, RIGHT, SURROUND RIGHT, SURROUND LEFT
- 

Adjust the speaker level for each speaker. (CENTER, SURROUND RIGHT, SURROUND LEFT)
-6 dB to +6 dB (Factory preset: 0 dB)

 - To exit the screen, press [SETUP].

To adjust speaker level during play

(Effective when playing 5.1-channel sound or when "DOLBY" lights.)

- Press and hold [—CH SELECT] to select the speaker.**

While the speaker channel is displayed, press [—CH SELECT].

L → C → R → RS → LS → SW

- You can adjust SW (Subwoofer) only if the disc includes a subwoofer channel and "DOLBY" is not lit.
- "S" appears on the main unit's display when you have selected "S.SRND" (⇒ 12, Enjoying surround sound effects). In this case, you can adjust both surround speaker levels at the same time using [**▲**, **▼**].
S: -6 dB to +6 dB

- Press [**▲**] (increase) or [**▼**] (decrease) to adjust the speaker level for each speaker.**

C, RS, LS, SW: -6 dB to +6 dB

(L, R: Only the balance is adjustable.)

To adjust the balance of the front speakers, while "L" or "R" is selected, press [**◀**, **▶**].

Basic play

If you are experiencing problems, refer to troubleshooting (⇒ 30 to 31)

Preparation

To display the picture, turn on your TV and change its video input mode (e.g. VIDEO 1, AV 1, HDMI, etc.) to suit the connections to this unit.

Using the main unit

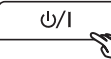
1  **Turn on the unit.**

2  **Select "DVD/CD".**

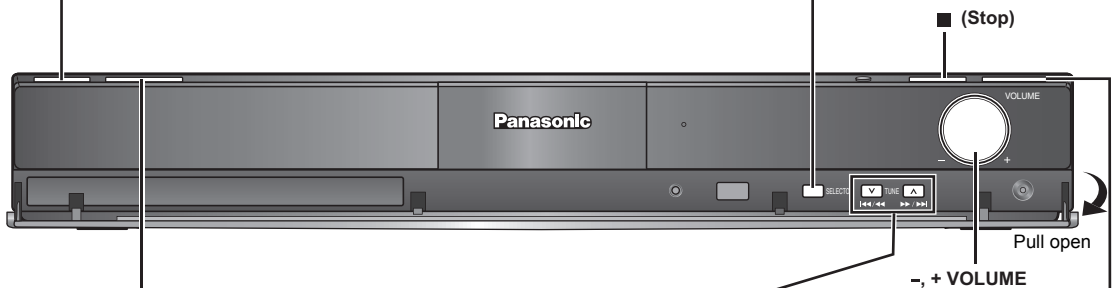

3  **Open the disc tray.**

4 **Load the disc.**

- Load double-sided discs so the label for the side you want to play is facing up.

Label facing up

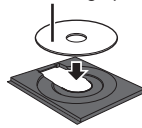

- For DVD-RAM, remove the disc from its cartridge before use.



 TUNE 

Press to skip.
Press and hold to

- search during play
- start slow-motion play during pause
- Press [▶] (Play) to start normal play.

5 

Start play.

- Turn [-, + VOLUME] to adjust the volume.

Note

• **DISC CONTINUES TO ROTATE WHILE MENUS ARE DISPLAYED.**

To preserve the unit's motor and your TV screen, press [■] (Stop) when you are finished with the menus.

• Total title number may not be displayed properly on +R/+RW.

• **ABOUT DIVX VIDEO:**

DivX® is a digital video format created by DivX, Inc. This is an official DivX Certified device that plays DivX video.

Using the remote control

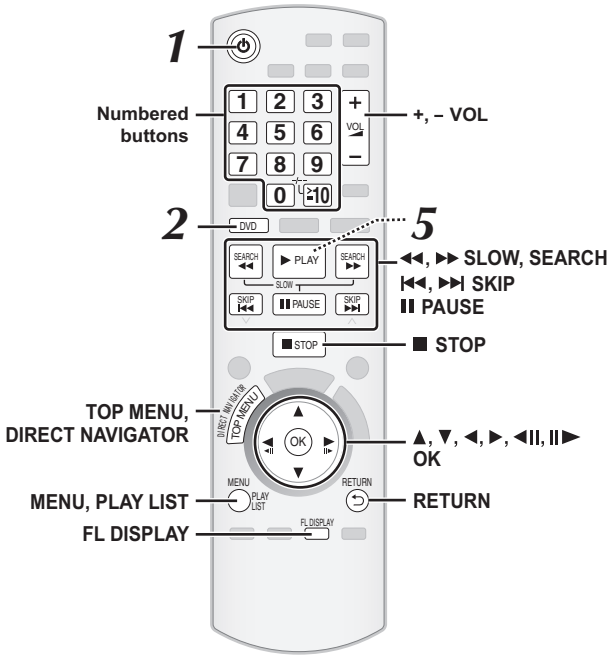

On-screen item select		—
------------------------------	--	---

Enter number		DVD-VR DVD-V VCD CD e.g. To select 12: [≥10] → [1] → [2]
		VCD with playback control Press [■ STOP] to cancel the PBC function, and then press the numbered buttons.

Disc menu		DVD-V Shows a disc top menu.
		DVD-VR Press the button to show the programs (⇒ 17).

		DVD-V Shows a disc menu.
		DVD-VR Press the button to show a play list (⇒ 17).

One touch play (during standby mode)		(Remote control only) The main unit automatically turns on and starts playing the disc in the tray.
--	--	--

Stop		The position is memorised while "RESUME STOP" is on the screen. <ul style="list-style-type: none"> Press [▶ PLAY] to resume. Press [■ STOP] again to clear the position.
-------------	--	--

Pause		<ul style="list-style-type: none"> Press [▶ PLAY] to restart play.
--------------	--	---

Skip		—
-------------	--	---

Search (during play)		<ul style="list-style-type: none"> Up to 5 steps. Press [▶ PLAY] to start normal play.
Slow-motion (during pause)		<ul style="list-style-type: none"> VCD Slow-motion: Forward direction only. MPEG4 DivX Slow-motion: Does not work.

Frame-by-frame (during pause)		DVD-VR DVD-V VCD <ul style="list-style-type: none"> DVD-VR VCD Forward direction only.
---	--	---

Return to previous screen		—
----------------------------------	--	---

Main unit display		DVD-VR DVD-V WMA MP3 MPEG4 DivX Time display ↔ Information display (e.g. DVD-VR Program number) JPEG SLIDE ↔ Contents number
--------------------------	--	--

Playing Discs

Other modes of play

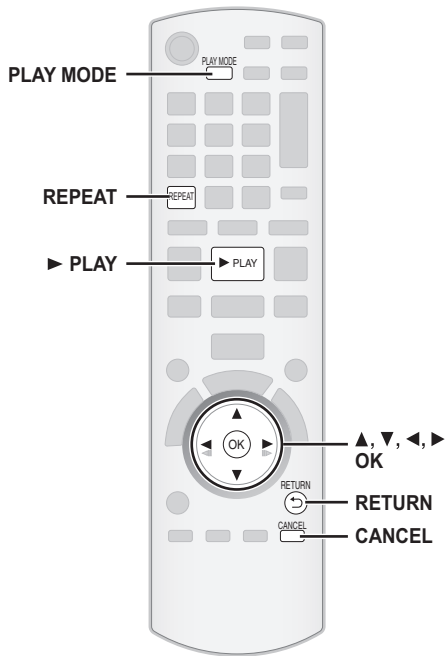

Repeat play

This works only when the elapsed play time can be displayed. It also works with all JPEG content.

During play



Select an item to be repeated.

e.g. DVD-V

TITLE → CHAP. → OFF

To cancel, select "OFF".

Items shown differ depending on the type of disc and playback mode.

Program and Random play

DVD-V VCD CD WMA MP3 JPEG MPEG4 DivX

Preparation

While stopped



Select the play mode.

Program and random playback screens appear sequentially.

Program → Random
 ← Exit program and random screens ←

- **DVD-VR** Select "DATA" in "DVD-VR/DATA" (⇒ 26, OTHERS menu) to play WMA, MP3, JPEG, MPEG4 or DivX contents.
- If "PLAYBACK MENU" screen appears, select "AUDIO/PICTURE" or "VIDEO" (⇒ 17, Using PLAYBACK MENU), then proceed with the above.
- For a disc with both WMA/MP3 and JPEG contents, select either music or picture contents.
 WMA/MP3: Select "MUSIC PROGRAM" or "MUSIC RANDOM".
 JPEG: Select "PICTURE PROGRAM" or "PICTURE RANDOM".
- **DVD-V** Some items cannot be played even if you have programmed them.

Program play (up to 30 items)

1



Select an item.

e.g. DVD-V

DVD-V PROGRAM	
SELECT TITLE	TITLE CHAPTER
TITLE 1	1
TITLE 2	2
TITLE 3	3
TITLE 4	4
	5
	6
	7
	8
	9
	10

START:PLAY CLEAR ALL

- Repeat this step to program other items.
- To return to the previous menu, press [RETURN].

2



Start play.

To select all the items

Press [▲, ▼] to select "ALL" and press [OK].

To clear the selected program

- 1 Press [▶] and then press [▲, ▼] to select the program.
- 2 Press [CANCEL].

To clear the whole program

Press [▶] several times to select "CLEAR ALL", and then press [OK]. The whole program is also cleared when the disc tray is opened, the unit is turned off or another source is selected.

Random play

1



(Only when the disc has groups or multiple titles.)

Select a group or title.

e.g. DVD-V

DVD-V RANDOM	
SELECT TITLE	
TITLE 1	
* TITLE 2	
TITLE 3	

PRESS PLAY TO START

- "*" represents selected. To deselect, press [OK] again.

2



Start play.

Using navigation menus

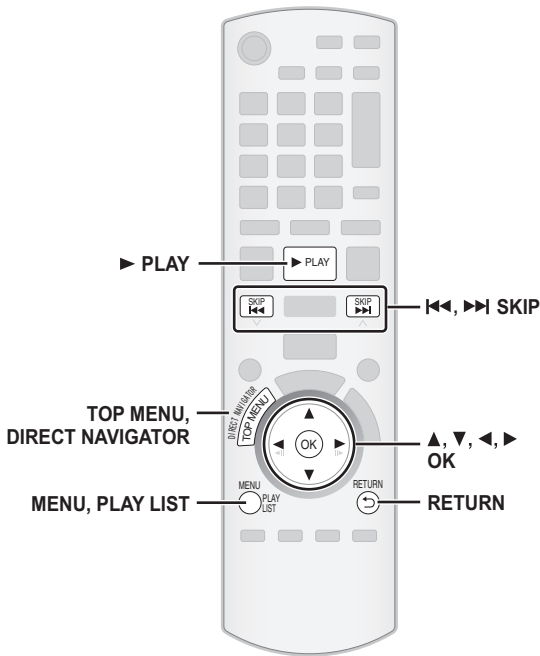

■ Selecting the picture in Thumbnail menu

JPEG

1 While picture is displayed e.g.

Group and content number

Group name

← JPEG images ▶ G 1/ 1:C 3/ 9

2 ▲, ▼, ◀, ▶

Select a picture.

- Press [◀, ▶] SKIP to skip page by page.

OK

To go to other group

- 1 Press [▲] to select the group name.
- 2 Press [◀, ▶] to select the group and press [OK].

Playing RAM and DVD-R/-RW (DVD-VR) discs

DVD-VR

- Titles appear only if the titles are recorded on the disc.
- You cannot edit programs, play lists and disc titles.

Playing the programs

1 While stopped e.g.

PG	DATE	LENGTH	TITLE
1	10/11 02:15	0:16:02	LIVE CONCERT
2	12/05 01:30	0:38:25	AUTO ACTION
3	04/03 02:10	1:16:05	CINEMA

OK
RETURN

- To exit the screen, press [DIRECT NAVIGATOR].

2 ▲, ▼ → OK

Select the program.

- Press [◀, ▶] to skip page by page.

Playing a play list

This works only when the disc contains a play list.

1 While stopped e.g.

PL	DATE	LENGTH	TITLE
1	11/11 00:01	0:00:10	CITY PENGUIN
2	12/01 01:20	0:01:20	FOOTBALL
3	01/02 01:10	1:10:04	SPECIAL

OK
RETURN

- To exit the screen, press [PLAY LIST].

2 ▲, ▼ → OK

Select the play list.

- Press [◀, ▶] to skip page by page.

Playing data discs

WMA MP3 JPEG MPEG4 DivX

[DVD-VR] Select "DATA" in "DVD-VR/DATA" (⇒ 26, OTHERS menu) to play WMA, MP3, JPEG, MPEG4 or DivX contents.

Using PLAYBACK MENU

"PLAYBACK MENU" screen appears when the disc contains both video (MPEG4/DivX) and other format (WMA/MP3/JPEG).

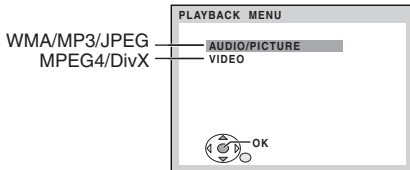

Select "AUDIO/PICTURE" or "VIDEO".

- To start play, press [▶] PLAY.
- To select an item to play, refer "Playing from the selected item" (⇒ below).

Playing from the selected item

You can select to play from your desired item while the "DATA-DISC" screen is displayed.

e.g.

Group (Folder):



Content (File):

🎵 : WMA/MP3

🖼️ : JPEG

🎬 : MPEG4/DivX

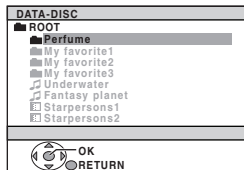

- To display/exit the screen, press [MENU].



Select an item.

- Press [◀, ▶] to skip page by page.
- To return to 1 level up from the current folder, press [RETURN].
- Maximum: 28 characters for file/folder name.

Play starts from the selected content.

Using on-screen menus

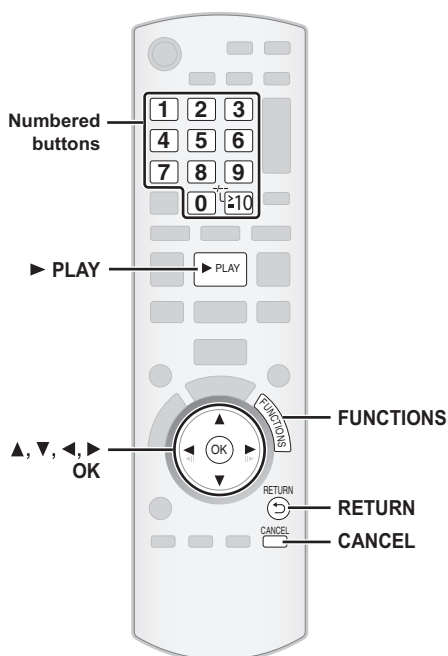

Items shown differ depending on the type of disc.

Menu 1 (Disc/Play)

- TRACK SEARCH** To start from a specific item
- TITLE SEARCH** • **[VCD]** This does not work when using playback control.
- CONTENT SEARCH** e.g. **[DVD-V]: T2 C5**
- CHAPTER SEARCH**
- PG SEARCH** To select numbers for data disc
- (Program Search)** e.g. 123: [≥10] ⇒ [1] ⇒ [2] ⇒ [3] ⇒ [OK]
- PL SEARCH** (Playlist Search)

AUDIO

- [DVD-V] [DivX]** (with multiple soundtracks)
 - To select audio soundtrack
 - [DVD-VR] [VCD]**
 - To select "L", "R", "L+R" or "L R"
 - [DVD-V]** (Karaoke disc)
 - To select "ON" or "OFF" for vocals
 - To select "OFF", "V1", "V2" or "V1+V2" for vocal selections
- Actual operations depend on the disc. Read the disc's instructions for details.

Signal type/data

LPCM/PPCM/□□□□/DTS/MP3/MPEG: Signal type
kHz (Sampling frequency)/bit/ch (Number of channels)

- e.g. 3/2 .1ch
- .1: Low frequency effect (not displayed if there is no signal)
 - 0: No surround
 - 1: Mono surround
 - 2: Stereo surround (left/right)
 - 1: Center
 - 2: Front left+Front right
 - 3: Front left+Front right+Center

- **[DivX]** It may take some time for play to start if you change the audio on a DivX video disc.

PLAY SPEED

- [DVD-VR] [DVD-V]**
- To change play speed
- from "×0.6" to "×1.4" (in 0.1-unit steps)
- Press **[▶ PLAY]** to return to normal play.
- After you change the speed
 - Dolby Pro Logic II has no effect.
 - Audio output switches to 2-channel stereo.
 - Sampling frequency of 96 kHz is converted to 48 kHz.
- This function may not work depending on the disc's recording.

REPEAT MODE

- (⇒ 16, Repeat play)
- A-B Repeat** (To repeat a specified section)
- Except **[JPEG] [MPEG4] [DivX] [DVD-VR]** (Still picture part) **[VCD]** (SVCD)
- Press **[OK]** at the starting and ending points.
- Select "OFF" to cancel.

SUBTITLE

- [DVD-V] [DivX]** (with multiple subtitles)
- [VCD]** (SVCD only)
- To select subtitle language
- On +R/+RW, a subtitle number may be shown for subtitles that are not displayed.
- [DVD-VR]** (with subtitle on/off information)
- To select "ON" or "OFF"
- This may not work depending on the disc.
- [DivX]** (⇒ 26, Displaying DivX subtitles text)

ANGLE

- [DVD-V]** (with multiple angles)
- To select a video angle

- 1**



Show the on-screen menu.

Each time you press the button:

 - Menu 1 (Disc/Play)
 - Menu 2 (Video)
 - Menu 3 (Audio)
 - Menu 4 (HDMI)
 - Exit

e.g. Menu 1 (Disc/Play) **[DVD-V]**

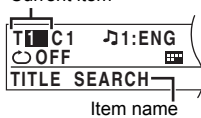

Item name
- 2**



Select the item.

e.g. Menu 1 (Disc/Play) **[DVD-V]**

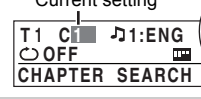



Current setting
- 3**



Make the settings.
- 4**





Exit.

 DATE DISPLAY	JPEG To select "ON" or "OFF" for picture's date display
 ROTATION	To rotate a picture (during pause) JPEG : 0 ↔ 90 ↔ 180 ↔ 270

Menu 2 (Video)

 PICTURE MODE	<p>NORMAL</p> <p>CINEMA1: Mellows images and enhances detail in dark scenes.</p> <p>CINEMA2: Sharpens images and enhances detail in dark scenes.</p> <p>DYNAMIC: Enhances the contrast for powerful images.</p> <p>ANIMATION: Suitable for animation.</p>
--	--

 ZOOM	To select zoom sizes NORMAL, AUTO (DVD-VR, DVD-V, VCD), ×2, ×4 ● JPEG : during pause
--	--

 TRANSFER MODE	<p>If you have chosen "480p"/"576p"/"720p"/"1080p" (progressive), "1080i" (interlaced) ["VIDEO FORMAT" in Menu 4 (HDMI)] or "PROGRESSIVE" under "VIDEO OUT (I/P)" (⇒ 25, VIDEO menu), select the method of conversion for progressive output to suit the type of material.</p> <p>● The setting will return to "AUTO" or "AUTO1" when the disc tray is opened, the unit is turned off or another source is selected.</p>
---	--

When playing PAL discs

AUTO: Automatically detects the film and video content, and appropriately converts it.

VIDEO: Select when using "AUTO", and the content is distorted.

FILM: Select this if the edges of the film content appear jagged or rough when "AUTO" is selected. However, if the video content is distorted as shown in the illustration to the right, then select "AUTO".



When playing NTSC discs

AUTO1: Automatically detects the film and video content, and appropriately converts it.

AUTO2: In addition to "AUTO1", automatically detects film contents with different frame rates and appropriately converts it.

VIDEO: Select if the video content is distorted when using "AUTO1" or "AUTO2".

 SOURCE SELECT DivX	When you select "AUTO" the constructing method of the DivX contents is automatically distinguished and output. If the picture is distorted, select "INTERLACE" or "PROGRESSIVE" depending on which constructing method was used when the contents were recorded to disc. AUTO, INTERLACE, PROGRESSIVE
--	---

Menu 3 (Audio)

 DIALOGUE ENHANCER	To make the dialogue in movies easier to hear DVD-V (Dolby Digital, DTS, 3-channel or higher, with the dialogue recorded in the center channel) DivX (Dolby Digital, 3-channel or higher, with the dialogue recorded in the center channel) OFF, ON
---	---

Menu 4 (HDMI)

HDMI HDMI STATUS	To show HDMI information. (⇒ below, Confirming HDMI information)
-----------------------------------	---

 HD ENHANCER	<p>This works when the HDMI connection is being used with "VIDEO PRIORITY" (⇒ 25, HDMI menu) set to "ON".</p> <p>To sharpen the "720p", "1080i" and "1080p" picture quality OFF, 1 (weakest) to 3 (strongest)</p>
---	--

 VIDEO FORMAT	<p>This works when the HDMI connection is being used with "VIDEO PRIORITY" (⇒ 25, HDMI menu) set to "ON".</p> <p>To select suitable picture quality with your TV (Video recordings will be converted to, and output as, high-definition video.)</p> <ul style="list-style-type: none"> * 480p/576p/720p/1080p (progressive) * 480i/576i/1080i (interlaced) <p>● If the picture is distorted, press and hold [CANCEL] until the picture is displayed correctly. (The output will return to "480p"/"576p".)</p> <ul style="list-style-type: none"> * The numbers displayed depend on the disc being played. One of the above numbers is displayed.
--	---

 COLOUR SPACE	<p>This works when the HDMI connection is being used with "VIDEO PRIORITY" (⇒ 25, HDMI menu) set to "ON".</p> <p>To select suitable picture colour with your TV YCbCr 4:2:2 YCbCr 4:4:4 RGB</p> <p>● If the setting above is not compatible with your TV, it will not be displayed.</p>
--	--

Confirming HDMI information

e.g.

HDMI - INFORMATION	
①	CONNECTED STATE CONNECTED
②	AUDIO STREAM PCM
③	MAX CHANNEL 2ch
④	VIDEO FORMAT 720p
⑤	COLOUR SPACE YCbCr 4:4:4

- ① Connection status
- ② Shows the output signal type.
- ③ Shows the number of audio channels.
- ④ (⇒ above, VIDEO FORMAT)
- ⑤ (⇒ above, COLOUR SPACE)

Note

When "OFF" is selected in "AUDIO OUT" (⇒ 25, HDMI menu), "-- --" will be displayed in "AUDIO STREAM".

Using the VIERA Link “HDAVI Control™”

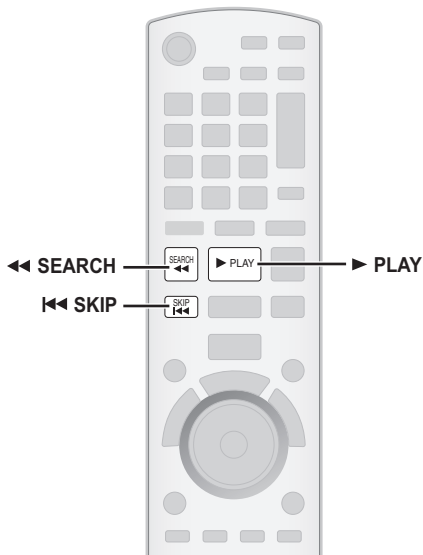

VIERA Link “HDAVI Control”

VIERA Link “HDAVI Control” is a convenient function that offers linked operations of this unit, and a Panasonic TV (VIERA) under “HDAVI Control”. You can use this function by connecting the equipment with the HDMI cable. See the operating instructions for connected equipment for operational details.

- VIERA Link “HDAVI Control”, based on the control functions provided by HDMI which is an industry standard known as HDMI CEC (Consumer Electronics Control), is a unique function that we have developed and added. As such, its operation with other manufacturers’ equipment that supports HDMI CEC cannot be guaranteed.
- This unit supports “HDAVI Control 4” function. “HDAVI Control 4” is the newest standard (current as of December 2008) for Panasonic’s HDAVI Control compatible equipment. This standard is compatible with Panasonic’s conventional HDAVI equipment.
- Please refer to individual manuals for other manufacturers’ equipment supporting VIERA Link function.

The TV with “HDAVI Control 2 or later” function enables the following operation: VIERA Link Control only with TV’s remote control (for “HDAVI Control 2 or later”) (⇒ 21).

Preparation

- Confirm that the HDMI connection has been made (⇒ 7).
- Set “VIERA Link” to “ON” (⇒ 25, HDMI menu).
- To complete and activate the connection correctly, turn on all VIERA Link “HDAVI Control” compatible equipment and set the TV to the corresponding HDMI input mode for this unit.

Setting the TV audio for VIERA Link “HDAVI Control”

Select between “AUX” and “DIGITAL IN” to work with the linked operations.

Refer to TV audio setting in Smart setup (⇒ 9) or “TV AUDIO” in HDMI menu (⇒ 25).

Confirm the audio connection to the AUX terminal (for “AUX”) or OPTICAL IN terminal (for “DIGITAL IN”) (⇒ 8).

Whenever the connection or settings are changed, reconfirm the points above.

※ “AUX” or “D-IN” (“DIGITAL IN”) works depending on the TV audio setting (⇒ above, Setting the TV audio for VIERA Link “HDAVI Control”).

Auto lip sync

(Available when using VIERA Link “HDAVI Control” with “HDAVI Control 3 or later” compatible TV)

This function automatically provides synchronised audio and video output. (This works only when the source is “DVD/CD”, “USB”, “AUX” or “D-IN”.)

- When using “DVD/CD” or “USB” as the source, set “TIME DELAY” in VIDEO menu to “0 ms/AUTO” (⇒ 24).

One touch play

You can turn on this unit and the TV, and start playing the disc with a single press of a button.

During standby mode



(Remote control only)

Start disc playback.

This unit’s speakers will be automatically activated (⇒ below).

Note

Playback may not be immediately displayed on the TV. If you miss the beginning portion of playback, press [◀◀] or [◀] to go back to where playback started.

Auto input switching

- When you switch the TV input to TV tuner mode, this unit will automatically switch to “AUX”* or “D-IN”*. (For “IPOD” mode, this works only in iPod music mode, or when iPod is not connected.)
- When this unit is in “DVD/CD” mode, the TV will automatically switch its input mode for this unit.
- When playback stops (DVD-V | VCD) or when this unit turns off, the TV will automatically return to TV tuner mode.
- When you select “AUX”* or “DIGITAL IN”* from “Input Selection” in START menu (⇒ 11), the TV will automatically switch to TV tuner mode.

Power off link

When the TV is turned off, this unit goes into standby mode automatically. To continue audio playback even when the TV is turned off, select “VIDEO” (⇒ 25, “POWER OFF LINK” in HDMI menu).

Note

- When you press [⏻], only this unit turns off. Other connected equipment compatible with VIERA Link “HDAVI Control” stays on.
- If this unit is connected to a “HDAVI Control 4” compatible TV with the “Intelligent Auto Standby” setting activated on the TV, the main unit will be automatically turned to standby under the following conditions: e.g.,
 - when changing the TV input from the one the main unit is connected
 - when changing the speaker use from this unit’s speakers to the TV speakers

For details, refer also to the operating instructions of your TV.

Speaker control

You can select whether audio is output from this unit’s speakers or the TV speakers by using the TV menu settings. For details, refer to the operating instructions of your TV.

Home Cinema

This unit’s speakers are active.

- When you turn on this unit, this unit’s speakers will be automatically activated.
- When this unit is in standby mode, changing the TV speakers to this unit’s speakers in the TV menu will automatically turn this unit on and select “AUX”* or “D-IN”* as the source.
- The TV speakers are automatically muted.
- You can control the volume setting using the volume or mute button on the TV’s remote control. (The volume level is displayed on the main unit’s display.)
- To cancel muting, you can also use this unit’s remote control (⇒ 34).
- If you turn off this unit, TV speakers will be automatically activated.

TV

TV speakers are active.

- The volume of this unit is set to “0”.
 - This function works only when “DVD/CD”, “USB”, “AUX”* or “D-IN”* is selected as the source on this unit.
- Audio output is 2-channel audio.

When switching between this unit speakers and TV speakers, the TV screen may be blank for several seconds.

VIERA Link Control only with TV's remote control (for "HDAVI Control 2 or later")

You can control the playback menus of this unit with the TV's remote control. When operating the TV's remote control, refer to the below illustration for operation buttons.

- 1 Select this unit's operation menu by using the TV menu settings. (For details, refer to the operating instructions of your TV.) The START menu will be shown. e.g. **DVD-V**

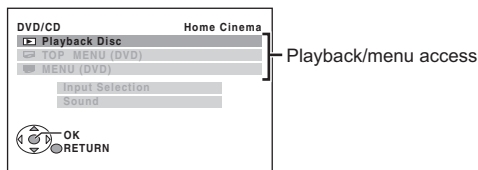

- The START menu can also be shown by using a button on the TV's remote control (e.g. [OPTION]).
 - When "DVD/CD" or "USB" is selected as the source, this works only during stop mode.
 - This does not work while iPod music playback screen is displayed on the TV.

- 2 Select the desired item on the START menu (⇒ 11).

When the on-screen control panel appears e.g. **DVD-V** (when "Playback Disc" is selected from the START menu.)

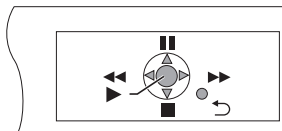

You can operate the playback with the indicated controls.

- The on-screen control panel can also be shown by using a button on the TV's remote control (e.g. [OPTION]).
 - This works only during "DVD/CD" or "USB" playback and resume modes or, while iPod music playback screen is displayed on the TV.

If the TV has automatically switched to the HDMI input mode for this unit (⇒ 20, Auto input switching)

The TV will automatically switch to TV tuner mode when:

- you press [EXIT] button on the TV's remote control.
- you press [EXIT] or [RETURN] button on the TV's remote control to exit the START menu.

This does not work during playback or resume mode when "DVD/CD" or "USB" is selected as the source. (For "IPOD" mode, this works only in iPod music mode, or when iPod is not connected.)

Note

- Depending on the menu, some button operations cannot be performed from the TV's remote control.
- You cannot input numbers with the numbered buttons on the TV's remote control ([0] to [9]). Use this unit's remote control to select the play list etc.

Operating other devices

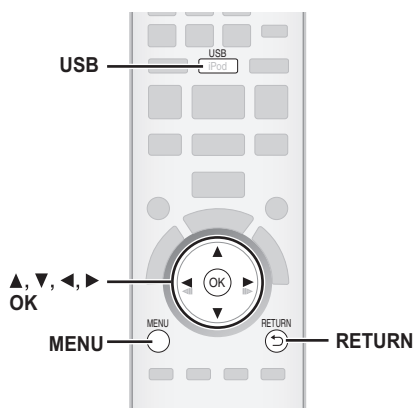

You can play an external device through your home theater system.

Playing from a USB device

You can connect and play tracks or files from USB mass storage class devices.

Devices which are defined as USB mass storage class:

- USB devices that support bulk only transfer.
- USB devices that support USB 2.0 full speed.

Preparation

- Before connecting any USB mass storage device to the unit, ensure that the data stored therein has been backed up.
- It is not recommended to use a USB extension cable. The USB device connected using the cable will not be recognised by this unit.

Connect the USB device (not included).

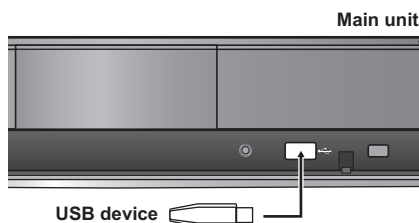

- 1 **Select "USB".**
The menu screen appears. e.g.
 - If "PLAYBACK MENU" screen appears, select "AUDIO/PICTURE" or "VIDEO" by pressing [▲, ▼] and then [OK].
 - To display/exit the screen, press [MENU].
- 2 **Select an item.**
 - Press [◀, ▶] to skip page by page.
 - To return to 1 level up from the current folder, press [RETURN].

Play starts from the selected content.

- For other operating functions, they are similar to those described in "Playing Discs" (⇒ 14 to 19).

Supported Formats

Still pictures	JPEG (Extension: ".jpg", ".JPG", ".jpeg", ".JPEG")
Music	MP3 (Extension: ".mp3", ".MP3") WMA (Extension: ".wma", ".WMA")
Video	MPEG4* (Extension: ".asf", ".ASF") DivX (Extension: ".divx", ".DIVX", ".avi", ".AVI")

* For Panasonic D-Snap/DIGA

Note

- Maximum: 255 folders (excluding Root folder), 4000 files, 28 characters for file/folder name.
- Only one memory card will be selected when connecting a multiport USB card reader. Typically the first memory card inserted.

(Continued on next page)

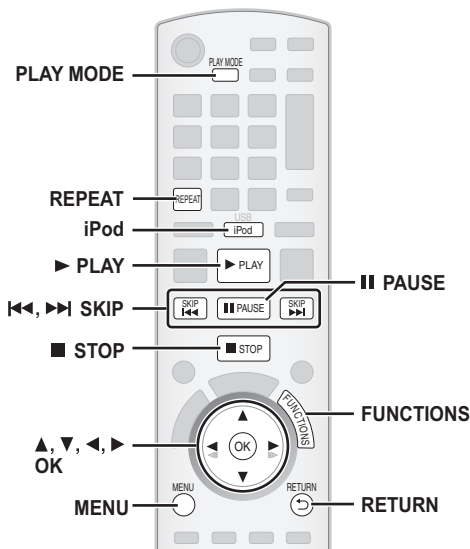

Using the iPod

You can enjoy iPod music through this unit's speakers or view iPod videos/photos on the TV.

Preparation

- To view photos/videos from the iPod
 - Ensure the video connection to the SCART (AV) terminal on this unit and select "VIDEO/YPbPr" from "VIDEO OUT – SCART" in VIDEO menu (⇒ 25).
 - Operate the iPod menu to make the appropriate photo/video output settings for your TV. (Refer to operating instructions of your iPod.)
- To display the picture, turn on the TV and select the appropriate video input mode.
- Before connecting/disconnecting the iPod, turn the main unit off or reduce the volume of the main unit to its minimum.

Connect the iPod (not included) firmly.

Recharging starts when the iPod is inserted.

e.g.

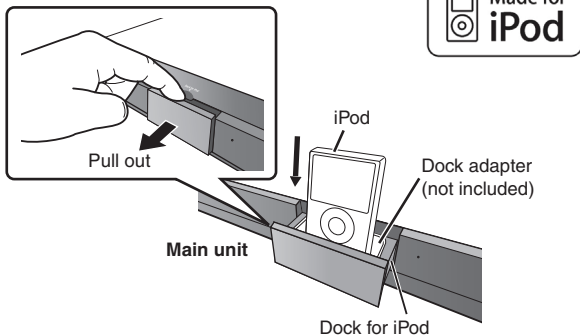

- Attach the dock adapter which should be supplied with your iPod to the dock for the stable use of the iPod. If you need an adapter, consult your iPod dealer.



Select "IPOD".

The iPod automatically switches to this unit's display mode.

Music menu appears on the TV.

e.g.



Select the menu.

Each time you press the button:

Music menu → Video menu
 ↑ iPod menu (iPod LCD) ←

When using the START menu in "IPOD" mode

e.g.

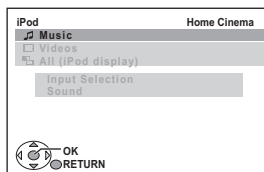

Music: Shows the music menu.

Videos: Shows the video menu.

All (iPod display): Switches to iPod menu.

Enjoying music/videos

1



Select music or video menu on the TV.

2



Select an item.

- Press [◀, ▶] to skip page by page.
- To return to the previous screen, press [RETURN].

Play starts from the selected song or video.

e.g. music playback screen

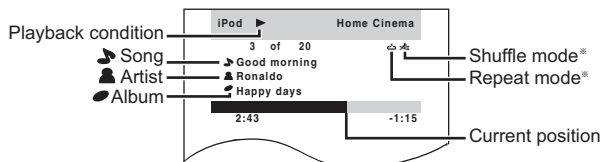

* These icons will only appear for music mode.



: Song shuffle
 : Album shuffle



: Repeat 1 song
 : Repeat all

Basic controls (For music and videos only)

Button	Function
[▶ PLAY]	Play
[■ STOP], [PAUSE]	Pause
[◀◀, ▶▶ SKIP]	Skip
(press and hold) [◀◀, ▶▶ SKIP]	Search

Other methods of playback

Shuffle mode (For music playback only)

Press [PLAY MODE] several times.

SONGS, ALBUMS, OFF

Repeat mode

Press [REPEAT] several times.

During the music/video playback: ONE, ALL, OFF



1 Select the iPod menu.

2 Play a slideshow on your iPod.

You can use the remote control to operate the iPod menu.
 [▲, ▼]: To navigate menu items.
 [OK]: To go to the next menu.
 [RETURN]: To return to the previous menu.

While an iPod is connected

- Do not push the Dock for iPod.

DO NOT



- Do not push or pull your iPod back and forth with great force.

DO NOT



About recharging the battery

- iPod will start recharging regardless of whether this unit is on or off.
- "IPOD *" will be shown on the main unit's display during iPod charging in main unit standby mode.
- Check iPod to see if the battery is fully recharged.
- If you are not using iPod for an extended period of time after recharging has completed, disconnect it from main unit, as the battery will be depleted naturally. (Once fully recharged, additional recharging will not occur.)

Compatible iPod

- iPod touch 2nd generation (8GB, 16GB, 32GB)
- iPod nano 4th generation (video) (8GB, 16GB)
- iPod classic (120GB)
- iPod touch 1st generation (8GB, 16GB, 32GB)
- iPod nano 3rd generation (video) (4GB, 8GB)
- iPod classic (80GB, 160GB)
- iPod nano 2nd generation (aluminum) (2GB, 4GB, 8GB)
- iPod 5th generation (video) (60GB, 80GB)
- iPod 5th generation (video) (30GB)
- iPod nano 1st generation (1GB, 2GB, 4GB)
- iPod 4th generation (color display) (40GB, 60GB)
- iPod 4th generation (color display) (20GB, 30GB)
- iPod 4th generation (40GB)
- iPod 4th generation (20GB)
- iPod mini (4GB, 6GB)

Compatibility depends on the software version of your iPod.

Speaker installation option

Attaching to a wall

You can attach all of the speakers (except subwoofer) to a wall.

- The wall or pillar on which the speakers are to be attached should be capable of supporting 10 kg per screw. Consult a qualified building contractor when attaching the speakers to a wall. Improper attachment may result in damage to the wall and speakers.

1 Drive a screw (not included) into the wall.

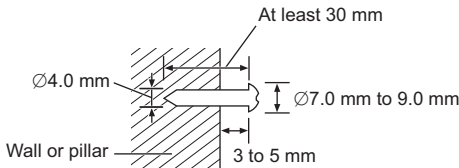

2 Fit the speaker securely onto the screw(s) with the hole(s).

PT570 Front speaker

PT670 Front and surround speakers

Attach to a wall without the base and the stand

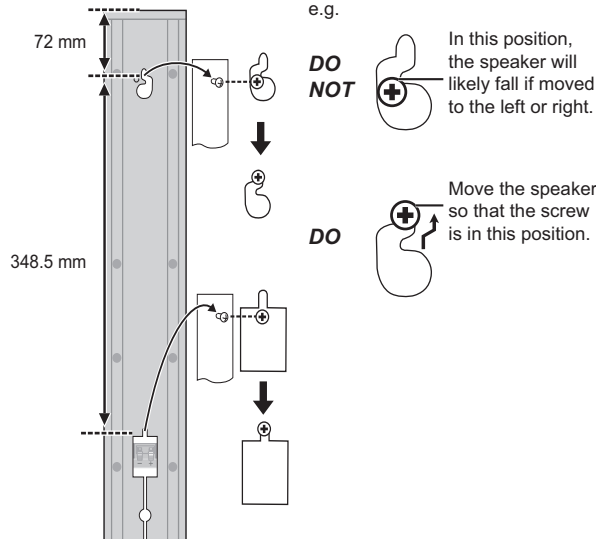

PT570

Surround speaker

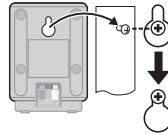

Center speaker

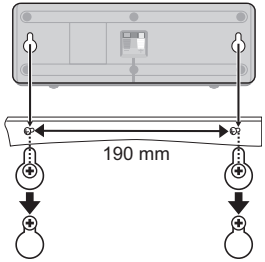

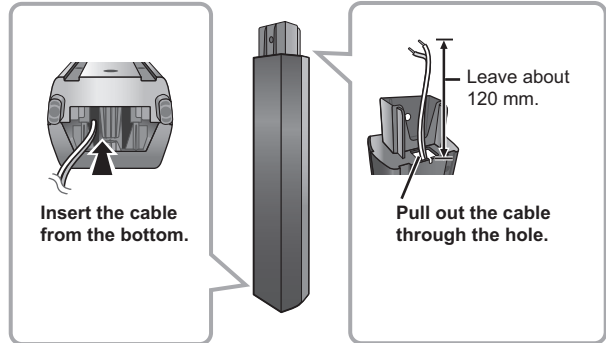

Reattaching the speaker cable



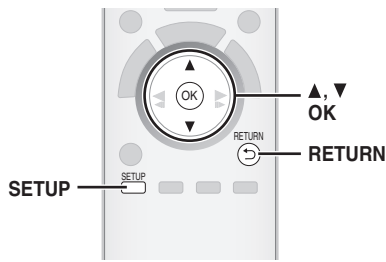

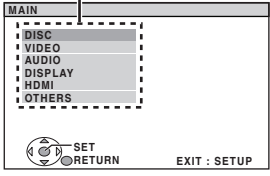
Changing the player settings

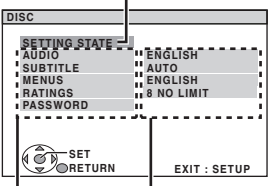

- 1**  **Show the setup menu.**

- 2**  **Select the menu.**
 Display the current setting of the items below

Item	Setting
SETTING STATE	ENGLISH
AUDIO	AUTO
SUBTITLE	ENGLISH
MENUS	NO LIMIT
RATINGS	
PASSWORD	

 - To return to the previous screen, press [RETURN].
- 3**  **Select the item.**
- 4**  **Make the settings.**
- 5**  **Exit.**

- The settings remain intact even if you switch the unit to standby.
- Underlined items are the factory settings in the following menus.

DISC menu

AUDIO

Choose the audio language.

- ENGLISH • FRENCH • SPANISH • GERMAN
- RUSSIAN • HUNGARIAN • CZECH • POLISH
- ORIGINAL*¹ • OTHER - - - -#²

SUBTITLE

Choose the subtitle language.

- AUTO*³ • ENGLISH • FRENCH • SPANISH
- GERMAN • RUSSIAN • HUNGARIAN • CZECH
- POLISH • OTHER - - - -#²

MENUS

Choose the language for disc menus.

- ENGLISH • FRENCH • SPANISH • GERMAN
- RUSSIAN • HUNGARIAN • CZECH • POLISH
- OTHER - - - -#²

- *¹ The original language designated on the disc is selected.
- *² Input the appropriate code from the language code list (⇒ 35).
- *³ If the language selected for "AUDIO" is not available, subtitles appear in that language (if available on the disc).

RATINGS

Set a rating level to limit DVD-Video play.

Setting ratings (When level 8 is selected)

- 0 LOCK ALL: To prevent play of discs without rating levels.
- 1 to 7
- 8 NO LIMIT

When you select your ratings level, a password screen is shown.

Follow the on-screen instructions.

Do not forget your password.

A message screen will be shown if a DVD-Video disc exceeding the rating level is inserted in the unit.

Follow the on-screen instructions.

PASSWORD

Change the password for "RATINGS".

- SETTING

To change ratings (When level 0 to 7 is selected)

- CHANGE: Follow the on-screen instructions.

VIDEO menu

TV ASPECT

Choose the setting to suit your TV.

- 16:9: Widescreen TV (16:9)
- 4:3PAN&SCAN: Regular aspect TV (4:3)
The sides of the widescreen picture are cut off so it fills the screen (unless prohibited by the disc).
- 4:3LETTERBOX: Regular aspect TV (4:3)
Widescreen picture is shown in the letterbox style.



TIME DELAY

When connected with a Plasma display, adjust if you notice the audio is out of sync with the video.

- 0 ms/AUTO • 20 ms • 40 ms • 60 ms
- 80 ms • 100 ms

When using VIERA Link "HDAVI Control" with "HDAVI Control 3 or later" compatible TV (⇒ 20), select "0 ms/AUTO".

Audio and video will automatically be set in sync.

NTSC DISC OUT

Choose PAL 60 or NTSC output when playing NTSC discs (⇒ 28, Video systems).

- NTSC: When connected to an NTSC TV.
- PAL 60: When connected to a PAL TV.

STILL MODE

Specify the type of picture shown when paused.

- AUTO
- FIELD*: The picture is not blurred, but picture quality is lower.
- FRAME*: Overall quality is high, but the picture may appear blurred.

* Refer to "Frame still and field still" (⇒ 33, Glossary).

VIDEO OUT – SCART

Choose the video signal format to be output from the SCART (AV) and COMPONENT VIDEO OUT terminals.

- **VIDEO/YPbPr**
- **S-VIDEO/YPbPr**
- **RGB 1/NO OUTPUT:** (Only when connected to a RGB compatible TV)
If you always would like to view the picture from the unit in RGB signal, select this mode. The TV screen will automatically switch to display the picture from the unit when the unit is turned on.
- **RGB 2/NO OUTPUT:** (Only when connected to a RGB compatible TV)
When in TV tuner mode, if the selector is set to "DVD/CD", the TV screen will automatically switch to display the picture from the unit only during disc playback (**DVD-V** | **DVD-VR** | **VCD**) or when viewing on-screen menu of DVD/CD.

The TV picture will be displayed when the selector is set to "AV". With other selectors, the picture from this unit will be displayed.

VIDEO OUT (I/P)

Select "PROGRESSIVE" only if connecting to a progressive output compatible TV.

- **INTERLACE**
- **PROGRESSIVE:** A message screen will appear. Follow the on-screen instructions.

AUDIO menu

Select to suit the type of equipment you connected to the HDMI AV OUT terminal.

Select "BITSTREAM" when the equipment can decode the bitstream (digital form of 5.1-channel data). Otherwise, select "PCM".

(If the bitstream is output to the equipment without a decoder, high levels of noise can be output and may damage your speakers and hearing.)

DOLBY DIGITAL*

- **BITSTREAM**
- **PCM**

DTS*

- **BITSTREAM**
- **PCM**

MPEG*

- **BITSTREAM**
- **PCM**

* When audio is output from HDMI AV OUT terminal, and the connected equipment does not support the item selected, the actual output will depend on the performance of this connected equipment.

DYNAMIC RANGE

- **ON:** Adjusts for clarity even when the volume is low. Convenient for late night viewing. (Only works with Dolby Digital)
- **OFF**

SPEAKER SETTINGS

Select the delay time of the speakers.

(Effective when playing 5.1-channel sound)

(Center and surround speakers only)

For optimum listening with 5.1-channel sound, all the speakers, except for the subwoofer, should be the same distance from the seating position.

If you have to place the center or surround speakers closer to the seating position, adjust the delay time to make up for the difference.

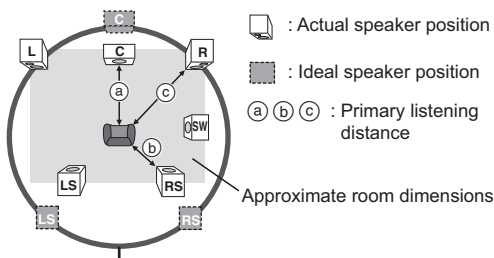

Circle of constant primary listening distance

If either distance (a) or (b) is less than (c), find the difference in the table and change to the recommended setting.

a) Center speaker		b) Surround speaker	
Difference (Approx.)	Setting	Difference (Approx.)	Setting
30 cm	1ms	150 cm	5ms
60 cm	2ms	300 cm	10ms
90 cm	3ms	450 cm	15ms
120 cm	4ms		
150 cm	5ms		

SETTINGS:

- **C DELAY (Center Delay):**
0ms, 1ms, 2ms, 3ms, 4ms, 5ms
Select the delay time for your center speaker.
- **LS/RS DELAY (Left Surround/Right Surround Delay):**
0ms, 5ms, 10ms, 15ms
Select the delay time for your surround speakers.
- **TEST TONE: SETTING**
Use the test tone for speaker level adjustments (⇒ 13, Adjusting the speaker output level manually).

DISPLAY menu

LANGUAGE

Choose the language for the on-screen messages.

- **ENGLISH**
- **FRANÇAIS**
- **ESPAÑOL**
- **DEUTSCH**
- **РУССКИЙ**
- **MAGYAR**
- **ČESKY**
- **POLSKI**

HDMI menu

VIDEO PRIORITY

- **ON:** When using the HDMI AV OUT terminal for video output. The resolution of the video output from the HDMI AV OUT terminal is optimized according to the capability of the connected equipment (e.g. TV).
- **OFF:** When not using the HDMI AV OUT terminal for video output. Video output will not depend on the connected equipment, but on this unit.

AUDIO OUT

- **ON:** When audio output is from the HDMI AV OUT terminal. (Depending on the capabilities of the connected equipment, audio output may differ from the audio settings of the main unit.)
- **OFF:** When audio output is not from the HDMI AV OUT terminal. (The audio is output using the settings of the main unit.)

RGB RANGE

This works only when "COLOUR SPACE" in Menu 4 (HDMI) is set to RGB (⇒ 19).

- **STANDARD**
- **ENHANCED:** When the black and white images are not distinct.

VIERA Link

- **ON:** The VIERA Link "HDAVI Control" function is available (⇒ 20).
- **OFF**

POWER OFF LINK

Select the desired power off link setting of this unit for VIERA Link operation (⇒ 20). (This works depending on the settings of the connected VIERA Link "HDAVI Control" compatible equipment.)

- **VIDEO/AUDIO:** When the TV is turned off, this unit will turn off automatically.
- **VIDEO:** When the TV is turned off, this unit will turn off except during the following conditions:
 - audio playback (**CD** | **MP3** | **WMA**)
 - iPod mode
 - radio mode
 - "AUX" or "D-IN" mode (non-selected TV audio setting for VIERA Link)

TV AUDIO

Select the TV audio input to work with the VIERA Link operations (⇒ 20).

- **AUX**
- **DIGITAL IN**

(Continued on next page)

Changing the player settings (continued)

OTHERS menu

REGISTRATION DivX

Display the unit's registration code.

● SHOW CODE

You need this registration code to purchase and play DivX Video-on-Demand (VOD) content (⇒ below).

JPEG TIME

Set the speed of the slideshow.

Factory preset: 3 SEC

- 1 SEC to 15 SEC (in 1-unit steps)
- 15 SEC to 60 SEC (in 5-unit steps)
- 60 SEC to 180 SEC (in 30-unit steps)

FL DIMMER

Change the brightness of the unit's display and indicator.

● BRIGHT

- DIM: The display is dimmed. (SURROUND OUTPUT indicator will turn off even if it is activated.)
- AUTO: The display is dimmed, but brightens when you perform some operations. (The SURROUND OUTPUT indicator will turn on if it is activated, when you perform some operations.)

DVD-VR/DATA

Select to play only DVD-VR or DATA format.

- DVD-VR: To play the video programs on DVD-RAM or DVD-R/-RW.
- DATA: To play the data files on DVD-RAM or DVD-R/-RW.

SCREEN DIMMER

This is to prevent burn mark on the TV screen.

- OFF
- WAIT 5 MIN: If there is no operation for 5 minutes, the picture turns gray. The TV screen would resume when you perform some operations. (This does not work during video playback.)

DEFAULTS

This returns all values in the MAIN menu to the default settings.

● RESET

The password screen is shown if "RATINGS" (⇒ 24) is set. Please enter the same password, then turn the unit off and on again.

DivX information

ABOUT DIVX VIDEO-ON-DEMAND:

This DivX® Certified device must be registered in order to play DivX Video-on-Demand (VOD) content.

First generate the DivX VOD registration code for your device and submit it during the registration process. [Important: DivX VOD content is protected by a DivX DRM (Digital Rights Management) system that restricts playback to registered DivX Certified devices. If you try to play DivX VOD content not authorized for your device, the message "AUTHORIZATION ERROR" will be displayed and your content will not play.]

Learn more at www.divx.com/vod.

Display the unit's registration code

(⇒ above, "REGISTRATION" in OTHERS menu)

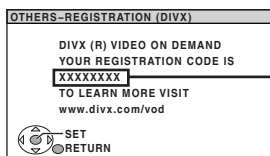

8 alphanumeric characters

- We recommend that you make a note of this code for future reference.
- After playing DivX VOD content for the first time, another registration code is then displayed in "REGISTRATION (DIVX)". Do not use this registration code to purchase DivX VOD content. If you use this code to purchase DivX VOD content, and then play the content on this unit, you will no longer be able to play any content that you purchased using the previous code.

Regarding DivX content that can only be played a set number of times

Some DivX VOD content can only be played a set number of times. When you play this content, the remaining number of plays is displayed. You cannot play this content when the number of remaining plays is zero. ("RENTAL EXPIRED" is displayed.)

When playing this content

- The number of remaining plays is reduced by one if
 - you press [◀] or [SETUP].
 - you press [■ STOP].
 - you press [◀◀, ▶▶ SKIP] or [◀◀, ▶▶ SEARCH] etc. and arrive at another content.

Resume function (⇒ 15, Stop) does not work.

Displaying DivX subtitles text

You can display subtitles text recorded onto the DivX video disc on this unit. Depending on the methods used to create the file, the following functions may not work, or the subtitles may not be displayed correctly.

- 1 During play, select "SUBTITLE" in Menu 1 (⇒ 18).
- 2 Press [▲, ▼] to select "TEXT ON" and press [OK].
 - DivX video files that do not display "TEXT ON" do not contain subtitles text. Subtitles text cannot be displayed.
 - If the subtitles text are not displayed correctly, try changing the language settings (⇒ below).

Subtitles text language settings

[Only when "LANGUAGE" in DISPLAY menu is set to "ENGLISH" (⇒ 25).]

- 1 During play, press [SETUP].
- 2 Press [▲, ▼] to select "DISC" and press [OK].
- 3 Press [▲, ▼] to select "SUBTITLE TEXT" and press [OK].
- 4 Press [▲, ▼] to select "LATIN1", "LATIN2" (factory setting), "CYRILLIC" or "TURKISH" and press [OK].
 - To exit the screen, press [SETUP].

Types of subtitles text file that can be displayed

Subtitles text that satisfy the following conditions can be displayed on this unit.

- File format: MicroDVD, SubRip, or TMLayer
- File extension: ".SRT", ".srt", ".SUB", ".sub", ".TXT", or ".txt"
- File name: No more than 44 characters excluding the file extension
- The DivX video file and subtitles text file are inside the same folder, and the file names are the same except for the file extensions.
- If there are more than one subtitles text files inside the same folder, they are displayed in the following order of priority: ".srt", ".sub", ".txt".

Note

- If the file name of the DivX video file is not displayed correctly on the menu screen (the file name is displayed as "*"), or the file size exceeds 256KB, the subtitles text may not be displayed correctly.
- The subtitles text cannot be displayed during menu display or when operations such as search are being performed.

Safety precautions

Placement

Set the unit up on an even surface away from direct sunlight, high temperatures, high humidity, and excessive vibration. These conditions can damage the cabinet and other components, thereby shortening the unit's service life.

Do not place heavy items on the unit.

Voltage

Do not use high voltage power sources. This can overload the unit and cause a fire.

Do not use a DC power source. Check the source carefully when setting the unit up on a ship or other places where DC is used.

AC mains lead protection

Ensure the AC mains lead is connected correctly and not damaged. Poor connection and lead damage can cause fire or electric shock. Do not pull, bend, or place heavy items on the lead.

Grasp the plug firmly when unplugging the lead. Pulling the AC mains lead can cause electric shock.

Do not handle the plug with wet hands. This can cause electric shock.

Foreign matter

Do not let metal objects fall inside the unit. This can cause electric shock or malfunction.

Do not let liquids get into the unit. This can cause electric shock or malfunction. If this occurs, immediately disconnect the unit from the power supply and contact your dealer.

Do not spray insecticides onto or into the unit. They contain flammable gases which can ignite if sprayed into the unit.

Service

Do not attempt to repair this unit by yourself. If sound is interrupted, indicators fail to light, smoke appears, or any other problem that is not covered in these instructions occurs, disconnect the AC mains lead and contact your dealer or an authorized service center. Electric shock or damage to the unit can occur if the unit is repaired, disassembled or reconstructed by unqualified persons.

Extend operating life by disconnecting the unit from the power source if it is not to be used for a long time.

Information for Users on Collection and Disposal of Old Equipment and used Batteries



These symbols on the products, packaging, and/or accompanying documents mean that used electrical and electronic products and batteries should not be mixed with general household waste.

For proper treatment, recovery and recycling of old products and used batteries, please take them to applicable collection points, in accordance with your national legislation and the Directives 2002/96/EC and 2006/66/EC.

By disposing of these products and batteries correctly, you will help to save valuable resources and prevent any potential negative effects on human health and the environment which could otherwise arise from inappropriate waste handling.

For more information about collection and recycling of old products and batteries, please contact your local municipality, your waste disposal service or the point of sale where you purchased the items.

Penalties may be applicable for incorrect disposal of this waste, in accordance with national legislation.



For business users in the European Union

If you wish to discard electrical and electronic equipment, please contact your dealer or supplier for further information.

[Information on Disposal in other Countries outside the European Union]

These symbols are only valid in the European Union. If you wish to discard these items, please contact your local authorities or dealer and ask for the correct method of disposal.





Note for the battery symbol (bottom two symbol examples):

This symbol might be used in combination with a chemical symbol. In this case it complies with the requirement set by the Directive for the chemical involved.



Cd

Discs that can be played

Commercial discs

Disc	Logo	Indicated in these instructions by	Remarks
DVD-Video		DVD-V	High quality movie and music discs
Video CD		VCD	Music discs with video Including SVCD (Conforming to IEC62107)
CD		CD	Music discs

Recorded discs (○: Playable, —: Not playable)

Disc	Logo	Recorded on a DVD video recorder, etc.		Recorded on a personal computer, etc.					Finalizing ^{※6}
		DVD-VR ^{※2}	DVD-V ^{※4}	WMA	MP3	JPEG	MPEG4	DivX	
DVD-RAM		○	—	—	○	○	○	○	Not necessary
DVD-R/RW		○	○	—	○	○	○	○	Necessary
DVD-R DL		○ ^{※3}	○	—	—	—	—	—	Necessary
+R/+RW	—	—	○ ^{※5}	—	—	—	—	—	Necessary
+R DL	—	—	○ ^{※5}	—	—	—	—	—	Necessary
CD-R/RW ^{※1}	—	—	—	○	○	○	○	○	Necessary ^{※7}

● It may not be possible to play all the above-mentioned discs in some cases due to the type of disc, the condition of the recording, the recording method, or how the files were created (⇒ 29, Tips for making data discs).

^{※1} This unit can play CD-R/RW recorded with CD-DA or Video CD format.

^{※2} Discs recorded on DVD recorders or DVD video cameras, etc. using Version 1.1 of the Video Recording Format (a unified video recording standard).

^{※3} Discs recorded on DVD recorders or DVD video cameras using Version 1.2 of the Video Recording Format (a unified video recording standard).

^{※4} Discs recorded on DVD recorders or DVD video cameras using DVD-Video Format.

^{※5} Recorded using a format different from DVD-Video Format, therefore some functions cannot be used.

^{※6} A process that allows play on compatible equipment. To play a disc that is indicated as "Necessary", the disc must first be finalized on the device it was recorded on.

^{※7} Closing the session will also work.

Note about using a DualDisc

The digital audio content side of a DualDisc does not meet the technical specifications of the Compact Disc Digital Audio (CD-DA) format so playback may not be possible.

Discs that cannot be played

Blu-ray, HD DVD, AVCHD discs, DVD-RW version 1.0, DVD-Audio, DVD-ROM, CD-ROM, CDV, CD-G, SACD, Photo CD, DVD-RAM that cannot be removed from their cartridge, 2.6 GB and 5.2 GB DVD-RAM, and "Chaoji VCD" available on the market including CVD, DVCD and SVCD that do not conform to IEC62107.

Video systems

- This unit can play PAL and NTSC, but your TV must match the system used on the disc.
- PAL discs cannot be correctly viewed on an NTSC TV.
- This unit can convert NTSC signals to PAL 60 for viewing on a PAL TV (⇒ 24, "NTSC DISC OUT" in VIDEO menu).

Disc handling precautions

- Do not attach labels or stickers to discs. This may cause disc warping, rendering it unusable.
- Do not write on the label side with a ball-point pen or other writing instrument.
- Do not use record cleaning sprays, benzene, thinner, liquids which prevent static electricity, or any other solvent.
- Do not use scratch-proof protectors or covers.
- Do not use the following discs:
 - Discs with exposed adhesive from removed stickers or labels (rented discs, etc.).
 - Discs that are badly warped or cracked.
 - Irregularly shaped discs, such as heart shapes.

Tips for making data discs

Format	Disc	Extension	Reference
WMA	CD-R/RW	“.WMA” “.wma”	<ul style="list-style-type: none"> • Compatible compression rate: between 48 kbps and 320 kbps • You cannot play WMA files that are copy-protected. • This unit does not support Multiple Bit Rate (MBR: an encoding process for audio content that produces an audio file encoded at several different bit rates).
MP3	DVD-RAM DVD-R/RW CD-R/RW	“.MP3” “.mp3”	<ul style="list-style-type: none"> • This unit does not support ID3 tags. • Sampling frequency and compression rate: <ul style="list-style-type: none"> – DVD-RAM, DVD-R/RW: 11.02, 12, 22.05, 24 kHz (8 to 160 kbps), 44.1 and 48 kHz (32 to 320 kbps) – CD-R/RW: 8, 11.02, 12, 16, 22.05, 24 kHz (8 to 160 kbps), 32, 44.1 and 48 kHz (32 to 320 kbps)
JPEG	DVD-RAM DVD-R/RW CD-R/RW	“.JPG” “.jpg” “.JPEG” “.jpeg”	<ul style="list-style-type: none"> • JPEG files taken on a digital camera that conform to DCF Standard (Design rule for Camera File system) Version 1.0 are displayed. <ul style="list-style-type: none"> – Files that have been altered, edited or saved with computer picture editing software may not be displayed. • This unit cannot display moving pictures, MOTION JPEG and other such formats, still pictures other than JPEG (e.g. TIFF), or play pictures with attached audio.
MPEG4	DVD-RAM DVD-R/RW CD-R/RW	“.ASF” “.asf”	<ul style="list-style-type: none"> • You can play MPEG4 data [conforming to SD VIDEO specifications (ASF standard)/MPEG4 (Simple Profile) video system/G.726 audio system] recorded with Panasonic SD multi cameras or DVD recorders with this unit. • The recording date may differ from that of the actual date.
DivX	DVD-RAM DVD-R/RW CD-R/RW	“.DIVX” “.divx” “.AVI” “.avi”	<ul style="list-style-type: none"> • Plays all versions of DivX® video (including DivX®6) [DivX video system/MP3, Dolby Digital or MPEG audio system] with standard playback of DivX® media files. Functions added with DivX Ultra are not supported. • DivX files greater than 2 GB or have no index may not be played properly on this unit. • This unit supports all resolutions up to maximum of 720×480 (NTSC)/720×576 (PAL). • You can select up to 8 types of audio and subtitles on this unit.

- There may be differences in the display order on the menu screen and computer screen.
- This unit cannot play files recorded using packet write.

DVD-RAM

- Discs must conform to UDF 2.0.

DVD-R/RW

- Discs must conform to UDF bridge (UDF 1.02/ISO9660).
- This unit does not support multi-session. Only the default session is played.

CD-R/RW

- Discs must conform to ISO9660 level 1 or 2 (except for extended formats).
- This unit supports multi-session but if there are many sessions it takes more time for play to start. Keep the number of sessions to a minimum to avoid this.

Maintenance

To clean discs

Wipe with a damp cloth and then wipe dry.



Before moving the unit, ensure the disc tray is empty. Failure to do so will risk severely damaging the disc and the unit.

Clean this unit with a soft, dry cloth

- Never use alcohol, paint thinner or benzene to clean this unit.
- Before using chemically treated cloth, carefully read the instructions that came with the cloth.

Do not use commercially available lens cleaners as they may cause malfunction. Cleaning of the lens is generally not necessary although this depends on the operating environment.

Manufactured under license from Dolby Laboratories. Dolby, Pro Logic, and the double-D symbol are trademarks of Dolby Laboratories.

Manufactured under license under U.S. Patent #'s: 5,451,942; 5,956,674; 5,974,380; 5,978,762; 6,487,535 & other U.S. and worldwide patents issued & pending. DTS and DTS Digital Surround are registered trademarks and the DTS logos and Symbol are trademarks of DTS, Inc. © 1996-2008 DTS, Inc. All Rights Reserved.

U.S. Patent Nos. 6,836,549; 6,381,747; 7,050,698; 6,516,132; and 5,583,936.

This product incorporates copyright protection technology that is protected by U.S. patents and other intellectual property rights. Use of this copyright protection technology must be authorized by Macrovision, and is intended for home and other limited viewing uses only unless otherwise authorized by Macrovision. Reverse engineering or disassembly is prohibited.

HDMI, the HDMI logo and High-Definition Multimedia Interface are trademarks or registered trademarks of HDMI Licensing LLC.

HDAVI Control™ is a trademark of Panasonic Corporation.

iPod is a trademark of Apple Inc., registered in the U.S. and other countries.

Windows Media and the Windows logo are trademarks or registered trademarks of Microsoft Corporation in the United States and/or other countries.

This product is protected by certain intellectual property rights of Microsoft Corporation and third parties. Use or distribution of such technology outside of this product is prohibited without a license from Microsoft or an authorized Microsoft subsidiary and third parties.

This product is licensed under the MPEG-4 Visual patent portfolio license for the personal and non-commercial use of a consumer for (i) encoding video in compliance with the MPEG-4 Visual Standard ("MPEG-4 Video") and/or (ii) decoding MPEG-4 Video that was encoded by a consumer engaged in a personal and non-commercial activity and/or was obtained from a video provider licensed by MPEG LA to provide MPEG-4 Video. No license is granted or shall be implied for any other use. Additional information including that relating to promotional, internal and commercial uses and licensing may be obtained from MPEG LA, LLC. See <http://www.mpegla.com>.

Plays DivX® video
DivX® is a registered trademark of DivX, Inc., and is used under license.

Troubleshooting guide

Before requesting service, make the following checks. If you are in doubt about some of the check points, or if the solutions indicated in the following guide do not solve the problem, consult your dealer for instructions.

Power

No power.

Insert the AC mains lead securely. (⇒ 8)

The unit is automatically switched to standby mode.

The Sleep timer was working and had reached the set time limit. (⇒ 34)

Unit displays

The display is dark.

Select "BRIGHT" in "FL DIMMER" in the OTHERS menu. (⇒ 26)

"NO PLAY"

- You inserted a disc the unit cannot play; insert one it can. (⇒ 28)
- You inserted a blank disc.
- You inserted a disc that has not been finalized.

"NO DISC"

- You have not inserted a disc; insert one.
- You have not inserted the disc correctly; insert it correctly. (⇒ 14)

"OVER CURRENT ERROR"

The USB device is drawing too much power. Switch to DVD/CD mode, remove the USB and turn the unit off.

"IPOD OVER CURRENT ERROR"

The iPod is drawing too much power. Remove the iPod, and turn the unit off and on again.

"F61"

Check and correct the speaker cable connections. If this does not fix the problem, consult the dealer. (⇒ 6)

"F76"

There is a power supply problem. Consult the dealer.

"DVD U11"

Disc may be dirty. Wipe it clean. (⇒ 29)

"ERROR"

Incorrect operation performed. Read the instructions and try again.

"DVD H□□"

"DVD F□□□"

- stands for a number.
- Trouble may have occurred. The numbers following "H" and "F" depend on the status of the unit. Turn the unit off and then back on. Alternatively, turn the unit off, disconnect the AC mains lead, and then reconnect it.
- If the service numbers fail to clear, note the service number and contact a qualified service person.

"U70□"

- stands for a number. (The actual number following "U70" will depend on the state of the main unit.)
- The HDMI connection acts unusually.
 - The connected equipment is not HDMI-compatible.
 - Please use HDMI cables that have the HDMI logo (as shown on the cover).
 - The HDMI cable is too long.
 - The HDMI cable is damaged.

"REMOTE 1" or "REMOTE 2"

Match the modes on the main unit and remote control. Depending on the number being displayed ("1" or "2"), press and hold [OK] and the corresponding numbered button ([1] or [2]) for at least 2 seconds. (⇒ 34)

"LOADING"

- The iPod is not ready. Wait for this display to disappear.
- Disconnect the iPod, and then reconnect it firmly. (⇒ 22)

"NO MIC"

The Auto speaker setup microphone is not inserted. Check whether the Auto speaker setup microphone is plugged in properly into the SETUP MIC jack.

"NOISY"

Excessive ambient noise in the room. Perform the setup again and keep quiet during the Auto speaker setup.

General operation

No response when any buttons are pressed.

- This unit cannot play discs other than the ones listed in these operating instructions. (⇒ 28)
- The unit may not be operating properly due to lightning, static electricity or some other external factor. Turn the unit off and then back on. Alternatively, turn the unit off, disconnect the AC mains lead, and then reconnect it.
- Condensation has formed. Wait 1 to 2 hours for it to evaporate.

No response when remote control buttons are pressed.

- Check that the batteries are installed correctly. (⇒ 8)
- The batteries are depleted. Replace them with new ones. (⇒ 8)
- Aim the remote control at the remote control signal sensor and operate. (⇒ 35)

Other products respond to the remote control.

Change the remote control operating mode. (⇒ 34)

No picture or sound.

- Check the video or speaker connection. (⇒ 6, 7)
- Check the power or input setting of the connected equipment and the main unit.
- Check that the disc has something recorded on it.

You have forgotten your ratings password.

Reset all the settings to Factory Preset. While stopped and "DVD/CD" is the source, press and hold [■] (Stop) on the main unit and [≥10] on the remote control until "INITIALIZED" disappears from the TV. Turn the unit off and on again. All settings will return to the default values. (This does not work during program and random modes, or when setup menu or START menu is displayed.)

Some characters are not displayed correctly.

Characters other than English alphabet and Arabic numerals may not be displayed correctly.

The VIERA Link "HDAVI Control" function does not respond.

Depending on the condition of this unit or the connected equipment, it may be necessary to repeat the same operation so that the function can work correctly. (⇒ 20)

The setting you made in "TV ASPECT" (⇒ 24, VIDEO menu) or "LANGUAGE" (⇒ 25, DISPLAY menu) does not work.

The settings for "TV ASPECT"^{*1} and "LANGUAGE"^{*2} will automatically follow to the information from the TV. (⇒ 9, Smart setup settings)

^{*1} When using VIERA Link "HDAVI Control" with "HDAVI Control 3 or later" compatible TV

^{*2} When using VIERA Link "HDAVI Control" with "HDAVI Control 2 or later" compatible TV

Disc operation

It takes time before play starts.

- Play may take time to begin when an MP3 track has still picture data. Even after the track starts, the correct play time will not be displayed. This is normal. [MP3]
- This is normal on DivX video. [DivX]

A menu screen appears during skip or search. [VCD]

This is normal for Video CDs.

Playback control menu does not appear.

[VCD] with playback control Press [■ STOP] twice and then press [▶ PLAY].

Program and Random play do not work. [DVD-V]

These functions do not work with some DVD-Videos.

Play does not start.

- This unit may not play WMA and MPEG4 that contains still picture data.
- If playing DivX VOD content, refer to the homepage where you purchased the DivX VOD content. (Example: www.divx.com/vod) [DivX]
- If a disc contains CD-DA and other formats, proper playback may not be possible.

No subtitles.

- Display the subtitles. ("SUBTITLE" in Menu 1) (⇒ 18)
- Subtitles may not be displayed depending on the disc. **DivX**

Point B is automatically set.

The end of an item becomes point B when it is reached.

The Setup menu cannot be accessed.

- Select "DVD/CD" as the source.
- Cancel Program and Random play. (⇒ 16)

Sound

Sound is distorted.

- Noise may occur when playing WMA.
- When using the HDMI output, audio may not be output from other terminals.

Effects do not work.

Some audio effects do not work or have less effect with some discs.

Humming is heard during play.

An AC mains lead or fluorescent light is near the main unit. Keep other appliances and cables away from the main unit.

No sound.

- There may be a slight pause in sound when you change the play speed.
- Audio may not be output due to how files were created. **DivX**
- Audio may not be heard when more than 4 devices are connected with HDMI cables. Reduce the number of connected devices.
- When using the HDMI connection, ensure that "AUDIO OUT" in the HDMI menu is set to "ON". (⇒ 25)

No sound from the TV.

Confirm the audio connection. Press [EXT-IN] to select the corresponding source. (⇒ 8, 12)

No surround sound.

Press [SURROUND] to select "MULTI-CH". (⇒ 12)

Picture

The picture on the TV is not displayed correctly or disappears.

- The unit and TV are using different video systems. Use a multi-system or PAL TV.
- The system used on the disc does not match your TV.
 - PAL discs cannot be correctly viewed on an NTSC TV.
 - This unit can convert NTSC signals to PAL 60 for viewing on a PAL TV ("NTSC DISC OUT" in VIDEO menu). (⇒ 24)
- Ensure that the unit is connected directly to the TV, and is not connected through a VCR. (⇒ 7)
- Mobile telephone chargers can cause some disturbance.
- If you are using an indoor TV antenna, change to an outdoor antenna.
- The TV antenna wire is too close to the unit. Move it away from the unit.
- Change "SOURCE SELECT" in Menu 2. **DivX** (⇒ 19)
- Picture may not be seen when more than 4 devices are connected with HDMI cables. Reduce the number of connected devices.
- When using the COMPONENT VIDEO OUT terminal, ensure that progressive output is not selected when the connected TV is not progressive compatible. Press and hold [CANCEL] until "PRG" disappears from the main unit display and the picture is displayed correctly.
- When using the HDMI AV OUT terminal, ensure that video output unacceptable with the connected TV is not selected. Press and hold [CANCEL] until the picture is displayed correctly. (The output will return to "480p" or "576p".) (⇒ 19)
- Video images converted to 1920×1080 resolution may look different from the true native 1080p full-HD sources. This is not malfunction of the main unit.
- When the HDMI cable is connected, there will be no RGB output from the SCART (AV) terminal. If the SCART (AV) terminal is to be used, remove the HDMI cable and turn this unit on/off again.

Picture stops. **DivX**

Picture may stop if the DivX files are greater than 2 GB.

Picture size does not fit the screen.

- Change "TV ASPECT" in the VIDEO menu. (⇒ 24)
- Use the TV to change the aspect.
- Change the zoom setting. ("ZOOM" in Menu 2) (⇒ 19)

Menu is not displayed correctly.

Restore the zoom ratio to "NORMAL". ("ZOOM" in Menu 2) (⇒ 19)

Auto zoom function does not work well.

- Turn off TV's zoom function.

- Zoom function may not work well, especially in dark scenes and may not work depending on the type of disc.

When playing PAL disc, picture distorted.

Set "TRANSFER MODE" in Menu 2 to "AUTO". (⇒ 19)

After choosing "Home Cinema" in "Speaker control" with the TV's remote control, the TV's input selection also changes.

Disconnect the HDMI cable from the TV and reconnect it to a different HDMI terminal.

iPod operation

Cannot charge or operate.

- Check that the iPod is connected firmly. (⇒ 22)
- The battery of the iPod is depleted. Charge the iPod, and then operate again.

Cannot display iPod photos/videos on the TV.

- Ensure the video connection to the SCART (AV) terminal on this unit and select "VIDEO/Y/PbPr" from "VIDEO OUT – SCART" in VIDEO menu. (⇒ 25)
- Operate the iPod menu to make the appropriate photo/video output settings for your TV. (Refer to operating instructions for your iPod.)

HDMI or progressive video

There is ghosting when HDMI or progressive output is on.

- This problem is caused by the editing method or material used on DVD-Video, but should be corrected if you use interlaced output. When using the HDMI AV OUT terminal, set "VIDEO FORMAT" in Menu 4 to "480i" or "576i". Or, disable the HDMI AV OUT connection and use other video connections. (⇒ 7, 19)
- When using the COMPONENT VIDEO OUT terminal, set "VIDEO OUT (I/P)" in VIDEO menu to "INTERLACE". (Alternatively, press and hold [CANCEL] until "PRG" disappears from the main unit display.) (⇒ 25)

Pictures not in progressive output.

- Select "PROGRESSIVE" in "VIDEO OUT (I/P)" in VIDEO menu. (⇒ 25)
- The unit's SCART (AV) terminal outputs the interlaced signal even if "PRG" is displayed.

Radio

Distorted sound or noise is heard.

"ST" flickers or does not light.

- Adjust the position of the FM antenna.
- Use an outdoor antenna. (⇒ 6)

A beat sound is heard.

Turn the TV off or move it away from the unit.

USB

The USB drive or its contents cannot be read.

- The USB drive format or its contents is/are not compatible with the system. (⇒ 21)
- The USB host function of this product may not work with some USB devices.
- USB devices with storage capacity of more than 32 GB may not work in some instances.

Slow operation of the USB device.

Large file size or high memory USB device takes longer time to read and display on the TV.

TV displays

"⊘"

The operation is prohibited by the unit or disc.

"THIS DISC CANNOT BE PLAYED IN YOUR REGION."

Only DVD-Video discs that include or have the same region number as the one on the rear panel of this unit can be played. (⇒ Cover page)

"AUTHORIZATION ERROR" **DivX**

You are trying to play the DivX VOD content that was purchased with a different registration code. You cannot play the content on this unit. (⇒ 26)

"RENTAL EXPIRED" **DivX**

The DivX VOD content has zero remaining plays. You cannot play it. (⇒ 26)

"No Video"

Depending on the connected iPod, video menu may not be available on the TV.

Select iPod menu (iPod LCD) mode (⇒ 22) and operate video playback from your iPod menu.

Specifications

AMPLIFIER SECTION

RMS Output Power: Dolby Digital Mode

Front Ch	125 W per channel (3 Ω), 1 kHz, 10 % THD
Surround Ch	125 W per channel (3 Ω), 1 kHz, 10 % THD
Center Ch	250 W per channel (6 Ω), 1 kHz, 10 % THD
Subwoofer Ch	250 W per channel (6 Ω), 100 Hz, 10 % THD
Total RMS Dolby Digital mode power	1000 W

DIN Output Power: Dolby Digital Mode

Front Ch	90 W per channel (3 Ω), 1 kHz, 1 % THD
Surround Ch	90 W per channel (3 Ω), 1 kHz, 1 % THD
Center Ch	115 W per channel (6 Ω), 1 kHz, 1 % THD
Subwoofer Ch	115 W per channel (6 Ω), 100 Hz, 1 % THD
Total DIN Dolby Digital mode power	590 W

FM TUNER, TERMINALS SECTION

Preset Memory FM 30 stations

Frequency Modulation (FM)

Frequency range	87.50 MHz to 108.00 MHz (50-kHz step)
Antenna terminals	75 Ω (unbalanced)

Digital audio input

Optical digital input	Optical terminal
Sampling frequency	32 kHz, 44.1 kHz, 48 kHz

Phone jack

Terminal	Stereo, 3.5 mm jack
----------	---------------------

Calibration Mic

Sensitivity	100 mV, 1.4 kΩ
Terminal	Mono, 3.5 mm jack

USB Port

USB standard	USB 2.0 full speed
Media file format support	MP3 (*.mp3) WMA (*.wma) JPEG (*.jpg) (*.jpeg) DivX (*.divx, *.avi) MPEG4 (*.asf)
USB device file system	FAT12, FAT16, FAT32
USB Port power	Max. 500 mA
Bit rate	Up to 4 Mbps (DivX)

DISC SECTION

Discs played (8 cm or 12 cm)

- (1) DVD (DVD-Video, DivX[®]5.6)
- (2) DVD-RAM (DVD-VR, MP3[®]2.5, JPEG[®]4.5, MPEG4[®]5.7, DivX[®]5.6)
- (3) DVD-R (DVD-Video, DVD-VR, MP3[®]2.5, JPEG[®]4.5, MPEG4[®]5.7, DivX[®]5.6)
- (4) DVD-R DL (DVD-Video, DVD-VR)
- (5) DVD-RW (DVD-Video, DVD-VR, MP3[®]2.5, JPEG[®]4.5, MPEG4[®]5.7, DivX[®]5.6)
- (6) +R/+RW (Video)
- (7) +R DL (Video)
- (8) CD, CD-R/RW (CD-DA, Video CD, SVCD[®]1, MP3[®]2.5, WMA[®]3.5, JPEG[®]4.5, MPEG4[®]5.7, DivX[®]5.6)
 - *1 Conforming to IEC62107
 - *2 MPEG-1 Layer 3, MPEG-2 Layer 3
 - *3 Windows Media Audio Ver.9.0 L3
Not compatible with Multiple Bit Rate (MBR)
 - *4 Exif Ver 2.1 JPEG Baseline files
Picture resolution: between 160×120 and 6144×4096 pixels (Sub sampling is 4:0:0, 4:2:0, 4:2:2 or 4:4:4). Extremely long and narrow pictures may not be displayed.
 - *5 The total combined maximum number of recognizable audio, picture and video contents and groups: 4000 audio, picture and video contents and 255 groups. (Excluding Root folder)
 - *6 Plays all versions of DivX[®] video (including DivX[®]6) with standard playback of DivX[®] media files. Certified to the DivX Home Theater Profile.
 - *7 MPEG4 data recorded with Panasonic SD multi cameras or DVD video recorders
Conforming to SD VIDEO specifications (ASF standard)/MPEG4 (Simple Profile) video system/G.726 audio system

Pick up

Wavelength (DVD/CD)	655/785 nm
Laser power (DVD/CD)	CLASS 1/CLASS 1M

Audio output (Disc)

Number of channels	5.1 ch (FL, FR, C, SL, SR, SW)
--------------------	--------------------------------

VIDEO SECTION

Video system PAL625/50, PAL525/60, NTSC

Composite video output

Output level	1 Vp-p (75 Ω)
Terminal	Scart jack (1 system)

S-video output

Y output level	1 Vp-p (75 Ω)
C output level	PAL; 0.3 Vp-p (75 Ω) NTSC; 0.286 Vp-p (75 Ω)
Terminal	Scart jack (1 system)

Component video output

Y output level	1 Vp-p (75 Ω)
P _B output level	0.7 Vp-p (75 Ω)
P _R output level	0.7 Vp-p (75 Ω)
Terminal	Pin jack (Y: green, P _B : blue, P _R : red) (1 system)

RGB video output

R output level	0.7 Vp-p (75 Ω)
G output level	0.7 Vp-p (75 Ω)
B output level	0.7 Vp-p (75 Ω)
Terminal	Scart jack (1 system)

HDMI AV output

Terminal	19-pin type A connector
----------	-------------------------

HDAVI Control

This unit supports "HDAVI Control 4" function.

SPEAKER SECTION

Front speakers SB-HF770

Type	1 way, 1 speaker system (Bass reflex)
Speaker unit(s)	Impedance 3 Ω
Full range	6.5 cm Cone type
Input power (IEC)	125 W [®] (Max)
Output sound pressure	79 dB/W (1.0 m)
Frequency range	80 Hz to 25 kHz (−16 dB) 90 Hz to 22 kHz (−10 dB)
Dimensions (W×H×D)	100 mm×530 mm×78 mm
Mass	0.92 kg

Full assembly with stand base

Dimensions (W×H×D) max	255 mm×1020 mm×255 mm
Dimensions (W×H×D) min	255 mm×550 mm×255 mm
Mass	2.3 kg

Surround speakers SB-HS470

Type	1 way, 1 speaker system (Bass reflex)
Speaker unit(s)	Impedance 3 Ω
Full range	6.5 cm Cone type
Input power (IEC)	125 W [®] (Max)
Output sound pressure	79 dB/W (1.0 m)
Frequency range	100 Hz to 25 kHz (−16 dB) 120 Hz to 22 kHz (−10 dB)
Dimensions (W×H×D)	92 mm×128 mm×81 mm
Mass	0.47 kg

PT870 Surround speakers SB-HS870

Type	1 way, 1 speaker system (Bass reflex)
Speaker unit(s)	Impedance 3 Ω
Full range	6.5 cm Cone type
Input power (IEC)	125 W [®] (Max)
Output sound pressure	79 dB/W (1.0 m)
Frequency range	80 Hz to 25 kHz (−16 dB) 90 Hz to 22 kHz (−10 dB)
Dimensions (W×H×D)	100 mm×530 mm×78 mm
Mass	0.92 kg

Full assembly with stand base

Dimensions (W×H×D) max	255 mm×1020 mm×255 mm
Dimensions (W×H×D) min	255 mm×550 mm×255 mm
Mass	2.3 kg

Center speaker SB-HC470

Type	2 way, 2 speaker system (Bass reflex)
Speaker unit(s)	Impedance 6 Ω
1. Woofer	6.5 cm Cone type
2. Full range	6.5 cm Cone type
Input power (IEC)	250 W [®] (Max)
Output sound pressure	81 dB/W (1.0 m)
Frequency range	82 Hz to 25 kHz (−16 dB) 99 Hz to 22 kHz (−10 dB)
Dimensions (W×H×D)	250 mm×94.5 mm×81 mm
Mass	1.15 kg

Subwoofer SB-HW560

Type	1 way, 1 speaker system (Kelton type)
Speaker unit(s)	Impedance 6 Ω
1. Woofer	16 cm Cone type
2. Passive Radiator	25 cm
Input power (IEC)	250 W (Max)
Output sound pressure	78 dB/W (1.0 m)
Frequency range	35 Hz to 200 Hz (−16 dB) 40 Hz to 198 Hz (−10 dB)
Dimensions (W×H×D)	181 mm×361 mm×315 mm
Mass	4.7 kg

GENERAL

Power supply	AC 220 V to 240 V, 50 Hz
Power consumption	Main unit 130 W
Dimensions (W×H×D)	430 mm×63 mm×327 mm
Mass	Main unit 3.4 kg
Operating temperature range	0 °C to +40 °C
Operating humidity range	35 % to 80 % RH (no condensation)

Power consumption in standby mode	approx. 0.2 W
--	---------------

**8 Rating with Low-cut filter equipped Amplifier

Note

- 1 Specifications are subject to change without notice. Mass and dimensions are approximate.
- 2 Total harmonic distortion is measured by a digital spectrum analyzer.

Glossary

Decoder

A decoder restores the coded audio signals on DVDs to normal. This is called decoding.

DivX

DivX is a popular media technology created by DivX, Inc. DivX media files contain highly compressed video with high visual quality that maintains a relatively small file size.

Dolby Digital

This is a method of coding digital signals developed by Dolby Laboratories. Apart from stereo (2-channel) audio, these signals can also be 5.1-channel sound.

DTS (Digital Theater Systems)

This surround system is used in many movie theaters around the world. There is good separation between the channels, so realistic sound effects are possible.

Dynamic range

Dynamic range is the difference between the lowest level of sound that can be heard above the noise of the equipment and the highest level of sound before distortion occurs.

Film and video

DVD-Videos are recorded using either film or video. This unit can determine which type has been used, then uses the most suitable method of progressive output.

Film: Recorded at 25 frames per second (PAL discs) or 24 frames per second (NTSC discs). (NTSC discs recorded at 30 frames per second as well).

Generally appropriate for motion picture films.

Video: Recorded at 25 frames/50 fields per second (PAL discs) or 30 frames/60 fields per second (NTSC discs). Generally appropriate for TV drama programs or animation.

Frame still and field still

Frames are the still pictures that go together to make a moving picture. There are about 30 frames shown each second.

One frame is made up of two fields. A regular TV shows these fields one after the other to create frames.

A still is shown when you pause a moving picture. A frame still is made up of two alternating fields, so the picture may appear blurred, but overall quality is high.

A field still is not blurred, but it has only half the information of a frame still so picture quality is lower.

HDMI (High-Definition Multimedia Interface)

HDMI is a next-generation digital interface for consumer electronic products. Unlike conventional connections, it transmits uncompressed digital video and audio signals on a single cable. This unit supports high-definition video output (720p, 1080i, 1080p) from the HDMI AV OUT terminal. To enjoy high-definition video, a high-definition compatible TV is required.

I/P/B

MPEG 2, the video compression standard adopted for use with DVD-Video, codes frames using these 3 picture types.

I: Intra coded picture

This picture has the best quality and is the best to use when adjusting the picture.

P: Predictive coded picture

This picture is calculated based on past I- or P-pictures.

B: Bidirectionally-predictive coded picture

This picture is calculated by comparing past and future I- and P-pictures so it has the lowest volume of information.

JPEG (Joint Photographic Experts Group)

This is a system used for compressing/decoding colour still pictures. The benefit of JPEG is less deterioration in picture quality considering the degree of compression.

Linear PCM (pulse code modulation)

These are uncompressed digital signals, similar to those found on CDs.

MP3 (MPEG Audio Layer 3)

An audio compression method that compresses audio to approximately one tenth of its size without any considerable loss of audio quality.

MPEG4

A compression system for use on mobile devices or a network, that allows highly efficient recording at a low bit rate.

Playback control (PBC)

If a Video CD has playback control, you can select scenes and information with menus.

Progressive/Interlaced

The PAL video signal standard has 576 interlaced (i) scan lines, whereas progressive scanning, called 576p, uses twice the number of scan lines. For the NTSC standard, these are called 480i and 480p respectively. Using progressive output, you can enjoy the high-resolution video recorded on media such as DVD-Video.

Your TV must be compatible to enjoy progressive video.

Sampling frequency

Sampling is the process of converting the heights of sound wave (analog signal) samples taken at set periods into digits (digital encoding).

Sampling frequency is the number of samples taken per second, so larger numbers mean more faithful reproduction of the original sound.

WMA

WMA is a compression format developed by Microsoft Corporation. It achieves the same sound quality as MP3 with a file size that is smaller than that of MP3.

Control reference guide

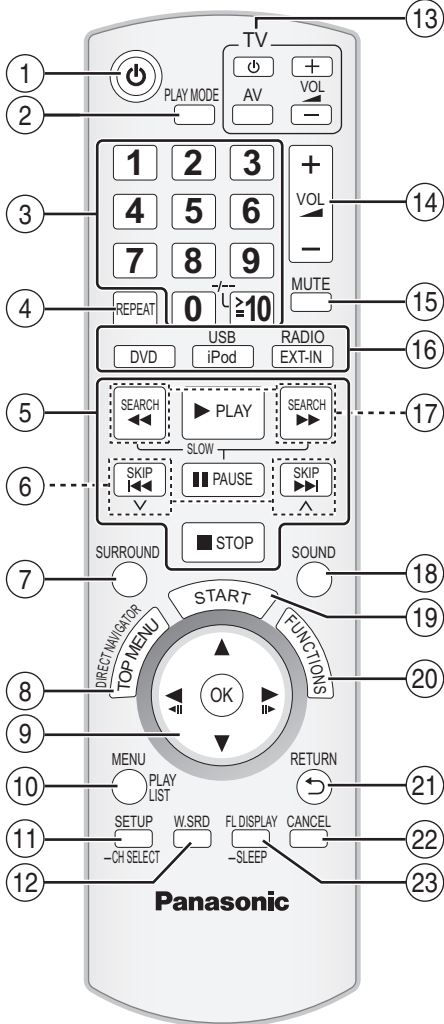

- ① Turn the main unit on/off (⇒ 9)
- ② Select the play mode (⇒ 16)
- ③ Select channels and title numbers etc. / Enter numbers (⇒ 10, 15)
- ④ Set the repeat mode (⇒ 16)
- ⑤ Basic operations for play (⇒ 14, 15)
- ⑥ Select preset radio stations (⇒ 10)
- ⑦ Select surround sound effects (⇒ 12)
- ⑧ Show a disc top menu or program list (⇒ 15, 17)
- ⑨ Select or confirm menu items / Frame-by-frame (⇒ 15)
- ⑩ Show a disc menu or play list (⇒ 15, 17)
- ⑪ Show setup menu or select speaker channel (⇒ 13, 24)
- ⑫ Turn Whisper-mode Surround on/off (⇒ 13)
- ⑬ **TV operations**
Aim the remote control at the Panasonic TV and press the button.
[TV]: Turn the TV on/off
[AV]: Change the TV's video input mode
[+, -]: Adjust the TV volume
This may not work properly with some models.
- ⑭ Adjust the volume of the main unit
- ⑮ **Mute the sound**
 - "MUTE" flashes on the main unit's display while the function is on.
 - To cancel, press the button again or adjust the volume.
 - Muting is cancelled when you switch the unit to standby.
- ⑯ **Source select**
[DVD]: Select disc as the source (⇒ 9)
[USB], [iPod]: Select USB or iPod as the source (⇒ 21, 22)
[RADIO], [EXT-IN]: Select FM tuner or external audio as the source (⇒ 10, 12)
FM→AV→AUX*→D-IN*
↑ ↓

- * "(TV)" will appear beside "AUX" or "D-IN", indicating the TV audio setting for VIERA Link "HDAVI Control" (⇒ 20).
- ⑰ Select radio stations manually (⇒ 10)
- ⑱ Select sound mode (⇒ 13)
- ⑲ Show START menu (⇒ 11)
- ⑳ Show on-screen menu / Display RDS text data (⇒ 11, 18)
- ㉑ Return to previous screen (⇒ 15)
- ㉒ Cancel (⇒ 16)
- ㉓ Switch information on the main unit's display (⇒ 15)
or
Set the Sleep timer
Press and hold [—SLEEP].
While the time is shown on the main unit's display, press [—SLEEP] repeatedly.
SLEEP 30 → SLEEP 60 → SLEEP 90 → SLEEP 120
↑ ↓ ↓ ↓
OFF (Cancel)
- To confirm the remaining time, press and hold the button again.

Avoiding interference with other Panasonic equipment

Other Panasonic audio/video equipment may start functioning when you operate the unit using the supplied remote control. You can operate this unit in another mode by setting the remote control operating mode to "REMOTE 2".

The main unit and remote control must be set to the same mode.

- 1 Press and hold [▶▶/▶▶|] on the main unit and [2] on the remote control until the main unit's display shows "REMOTE 2".
 - 2 Press and hold [OK] and [2] on the remote control for at least 2 seconds.
- To change the mode back to "REMOTE 1", repeat both steps above by replacing [2] with [1].

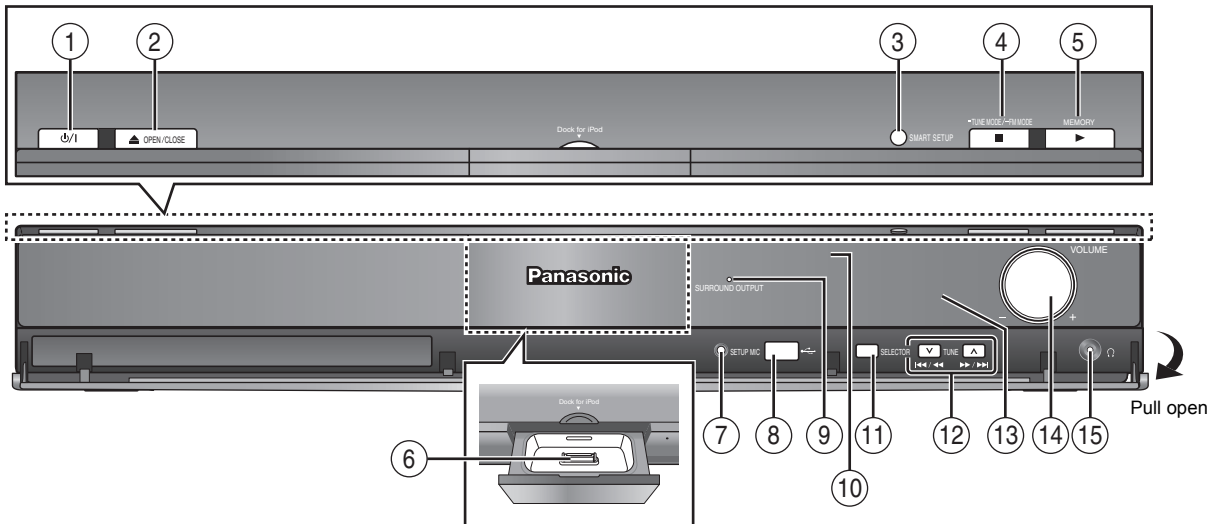

① Standby/on switch (⏻/⏻)

Press to switch the unit from on to standby mode or vice versa. In standby mode, the unit is still consuming a small amount of power. (⇒ 14)

② Open/Close the disc tray (⇒ 14)

③ Show the Smart setup (⇒ 9)

④ Stop playing / Select the tuning mode / Adjust the FM reception condition (⇒ 10, 14)

⑤ Play discs / Memorize the receiving radio stations (⇒ 10, 14)

⑥ Connect iPod (⇒ 22)

⑦ Connect Auto speaker setup microphone (⇒ 9)

⑧ Connect USB device (⇒ 21)

⑨ The indicator lights when there is surround sound effect (⇒ 12)

⑩ Remote control signal sensor

⑪ Select the source

DVD/CD→USB→FM→AV→AUX*→D-IN*→IPOD

* “(TV)” will appear beside “AUX” or “D-IN”, indicating the TV audio setting for VIERA Link “HDAVI Control” (⇒ 20).

⑫ Skip or slow-search play / Select the radio stations (⇒ 10, 14)

⑬ Display

⑭ Adjust the volume of the main unit

⑮ Connect headphones (not included)

Headphone plug type: Ø3.5 mm stereo mini plug

- Reduce the volume before connecting.
- Audio is automatically switched to 2-channel stereo.
- To prevent hearing damage, avoid listening for prolonged periods of time.

Excessive sound pressure from earphones and headphones can cause hearing loss.

Language code list

Abkhazian: 6566	Danish: 6865	Italian: 7384	Norwegian: 7879	Swedish: 8386
Afar: 6565	Dutch: 7876	Japanese: 7465	Oriya: 7982	Tagalog: 8476
Afrikaans: 6570	English: 6978	Javanese: 7487	Pashto, Pushto: 8083	Tajik: 8471
Albanian: 8381	Esperanto: 6979	Kannada: 7578	Persian: 7065	Tamil: 8465
Ameharic: 6577	Estonian: 6984	Kashmiri: 7583	Polish: 8076	Tatar: 8484
Arabic: 6582	Faroese: 7079	Kazakh: 7575	Portuguese: 8084	Telugu: 8469
Armenian: 7289	Fiji: 7074	Kirghiz: 7589	Punjabi: 8065	Thai: 8472
Assamese: 6583	Finnish: 7073	Korean: 7579	Quechua: 8185	Tibetan: 6679
Aymara: 6589	French: 7082	Kurdish: 7585	Rhaeto-Romance: 8277	Tigrinya: 8473
Azerbaijani: 6590	Frisian: 7089	Laotian: 7679	Romanian: 8279	Tonga: 8479
Bashkir: 6665	Galician: 7176	Latin: 7665	Russian: 8285	Turkish: 8482
Basque: 6985	Georgian: 7565	Latvian, Lettish: 7686	Samoan: 8377	Turkmen: 8475
Bengali, Bangla: 6678	German: 6869	Lingala: 7678	Sanskrit: 8365	Twi: 8487
Bhutani: 6890	Greek: 6976	Lithuanian: 7684	Scots Gaelic: 7168	Ukrainian: 8575
Bihari: 6672	Greenlandic: 7576	Macedonian: 7775	Serbian: 8382	Urdu: 8582
Breton: 6682	Guarani: 7178	Malagasy: 7771	Serbo-Croatian: 8372	Uzbek: 8590
Bulgarian: 6671	Gujarati: 7185	Malay: 7783	Shona: 8378	Vietnamese: 8673
Burmese: 7789	Hausa: 7265	Malayalam: 7776	Sindhi: 8368	Volapük: 8679
Byelorussian: 6669	Hebrew: 7387	Maltese: 7784	Singhalese: 8373	Welsh: 6789
Cambodian: 7577	Hindi: 7273	Maori: 7773	Slovak: 8375	Wolof: 8779
Catalan: 6765	Hungarian: 7285	Marathi: 7782	Slovenian: 8376	Xhosa: 8872
Chinese: 9072	Icelandic: 7383	Moldavian: 7779	Somali: 8379	Yiddish: 7473
Corsican: 6779	Indonesian: 7378	Mongolian: 7778	Spanish: 6983	Yoruba: 8979
Croatian: 7282	Interlingua: 7365	Nauru: 7865	Sundanese: 8385	Zulu: 9085
Czech: 6783	Irish: 7165	Nepali: 7869	Swahili: 8387	



Panasonic Corporation
Web Site: <http://panasonic.net>

En

Pursuant to at the directive 2004/108/EC, article 9(2)
Panasonic Testing Centre
Panasonic Marketing Europe GmbH
Winsberggring 15, 22525 Hamburg, Germany

RQTX0226-1R
F1208ZA1128