

Operating Instructions Home Theater Audio System

Model No. **SC-ZT2**



If you have any questions contact

In the U.S.A. and Puerto Rico: 1-800-211-PANA (7262)
In Canada: 1-800-561-5505

For U.S.A. and Puerto Rico only

The warranty can be found on page 30.
Please register via the Internet at:
www.Panasonic.com/register

For Canada only

The warranty can be found on page 31.

■ **SC-ZT2 Components**

SC-ZT2 has 2 system product numbers.

System product number	SC-ZT2PP-K
Main unit (control box part)	SU-ZT2PP-K
Speakers	SB-ZT2PP-K1
System product number	SC-ZT2PP-S
Main unit (control box part)	SU-ZT2PP-KA
Speakers	SB-ZT1PP-S1

Dear customer

Thank you for purchasing this product.
For optimum performance and safety, please read these instructions carefully.

Before connecting, operating or adjusting this product, please read the instructions completely.
Please keep this manual for future reference.



As an ENERGY STAR® Partner *, Panasonic has determined that this product meets the ENERGY STAR® guidelines for energy efficiency.

* For Canada only: The word "Participant" is used in place of the word "Partner".

HDMI

VIERA Link™

IMPORTANT SAFETY INSTRUCTIONS

Read these operating instructions carefully before using the unit. Follow the safety instructions on the unit and the applicable safety instructions listed below. Keep these operating instructions handy for future reference.

- 1) Read these instructions.
- 2) Keep these instructions.
- 3) Heed all warnings.
- 4) Follow all instructions.
- 5) Do not use this apparatus near water.
- 6) Clean only with dry cloth.
- 7) Do not block any ventilation openings. Install in accordance with the manufacturer's instructions.
- 8) Do not install near any heat sources such as radiators, heat registers, stoves, or other apparatus (including amplifiers) that produce heat.
- 9) Do not defeat the safety purpose of the polarized or grounding-type plug. A polarized plug has two blades with one wider than the other. A grounding-type plug has two blades and a third grounding prong. The wide blade or the third prong are provided for your safety. If the provided plug does not fit into your outlet, consult an electrician for replacement of the obsolete outlet.
- 10) Protect the power cord from being walked on or pinched particularly at plugs, convenience receptacles, and the point where they exit from the apparatus.
- 11) Only use attachments/accessories specified by the manufacturer.
- 12) Use only with the cart, stand, tripod, bracket, or table specified by the manufacturer, or sold with the apparatus. When a cart is used, use caution when moving the cart/apparatus combination to avoid injury from tip-over.
- 13) Unplug this apparatus during lightning storms or when unused for long periods of time.
- 14) Refer all servicing to qualified service personnel. Servicing is required when the apparatus has been damaged in any way, such as power-supply cord or plug is damaged, liquid has been spilled or objects have fallen into the apparatus, the apparatus has been exposed to rain or moisture, does not operate normally, or has been dropped.



	CAUTION RISK OF ELECTRIC SHOCK DO NOT OPEN	
CAUTION: TO REDUCE THE RISK OF ELECTRIC SHOCK, DO NOT REMOVE SCREWS. NO USER-SERVICEABLE PARTS INSIDE. REFER SERVICING TO QUALIFIED SERVICE PERSONNEL.		



The lightning flash with arrowhead symbol, within an equilateral triangle, is intended to alert the user to the presence of uninsulated "dangerous voltage" within the product's enclosure that may be of sufficient magnitude to constitute a risk of electric shock to persons.



The exclamation point within an equilateral triangle is intended to alert the user to the presence of important operating and maintenance (servicing) instructions in the literature accompanying the appliance.

	<p>Caution</p> <ul style="list-style-type: none"> • Use the speakers only with the recommended system. Failure to do so can damage the amplifier and speakers, and can cause fire. Consult a qualified service person if damage occurs or if a sudden change in performance is apparent. • Do not attach these speakers to walls or ceilings.
---	--

WARNING:

- TO REDUCE THE RISK OF FIRE, ELECTRIC SHOCK OR PRODUCT DAMAGE,**
- DO NOT EXPOSE THIS APPARATUS TO RAIN, MOISTURE, DRIPPING OR SPLASHING AND THAT NO OBJECTS FILLED WITH LIQUIDS, SUCH AS VASES, SHALL BE PLACED ON THE APPARATUS.
 - USE ONLY THE RECOMMENDED ACCESSORIES.
 - DO NOT REMOVE THE COVER (OR BACK); THERE ARE NO USER SERVICEABLE PARTS INSIDE. REFER SERVICING TO QUALIFIED SERVICE PERSONNEL.

CAUTION!

DO NOT INSTALL OR PLACE THIS UNIT IN A BOOKCASE, BUILT-IN CABINET OR IN ANOTHER CONFINED SPACE. ENSURE THE UNIT IS WELL VENTILATED. TO PREVENT RISK OF ELECTRIC SHOCK OR FIRE HAZARD DUE TO OVERHEATING, ENSURE THAT CURTAINS AND ANY OTHER MATERIALS DO NOT OBSTRUCT THE VENTILATION VENTS.

The unit should be installed near an accessible AC power outlet, with the power cord connected directly to it. To completely disconnect power from the unit, unplug the power cord from the AC power outlet.

CAUTION!

Do not place anything on top of this unit or block the heat radiation vents in any way. In particular, do not place DVD recorder or CD/DVD players on this unit as heat radiated from it can damage your software.

Table of contents

Before use	Setting up your Home Theater system 4 Supplied accessories 5	Control guide 5 Remote control preparation 7
Connection	Installation 8 Wireless functions 8 Home Theater connections ... 9 Basic connections 9 Connecting equipment with HDMI terminal (TV, DVD recorder, etc.) 9 Connecting STB etc. 10 Setting for automatically switching the input source to STB 10 Connecting cables to audio terminals (DVD player, etc.) 10 Connecting equipment without HDMI terminal (DVD player, VCR, etc.) 11 Other connections 12 To connect a second set of equipment that supports HDMI 12 To connect audio equipment (CD player, etc.) 12 To connect a subwoofer (not included) 12 AC power supply connection 12	Speaker setting 13 Setting the speakers 13 Checking the speaker setting 14 Installing surround speakers 14 Setting surround speakers 15 Changing the number of speakers to 4. 15
Play	Enjoying movies and music 16 Enjoying sound field effects 17 Dolby Virtual Speaker 17 SFC (Sound Field Control) 17 Canceling sound field effects 17 When connecting the surround speakers 17 Surround playback 17 SFC (Sound Field Control) 17 Dolby Pro Logic II 17 Using the VIERA Link “HDAVI Control™” 18 What you can do with VIERA Link “HDAVI Control” ... 18 Functions and settings 20 Using “WHISPER-MODE SURROUND” 20 Using “GAME” 20 Muting 20 Adjusting the bass (woofer part) output 20 Adjusting the surround speaker output 20 Adjusting the surround speaker output using the test signal 21 Setup menu items 21	Adjusting sound quality 21 Adjusting the volume balance of front speakers ... 21 Setting distances 22 Setting 7.1-channel virtual surround 22 Reducing Standby power consumption (In Standby condition (HDMI off mode)) 22 VIERA Link “HDAVI Control” setting 23 Adjusting the time lag between audio and video by delaying audio output 23 Switching between dual sounds 23 Clear audio at low volume 23 Switching the attenuator 23 Switching the input signal detection setting 24 Reset (factory settings) 24 When other equipment (mini component system, AV amp, etc.) manufactured by Panasonic operates with the remote control operations of this system 24
Troubleshooting and other information	Error messages 25 Using with headphones 25 Specifications 25 Troubleshooting guide 26 Digital signals that can be played on this system 27 Maintenance 27 Glossary 28	Product Service 29 Listening caution 29 Limited Warranty (ONLY FOR U.S.A. AND PUERTO RICO) 30 Limited Warranty (ONLY FOR CANADA) 31

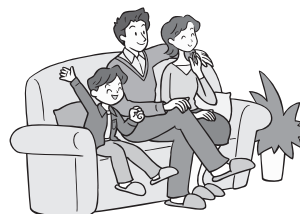
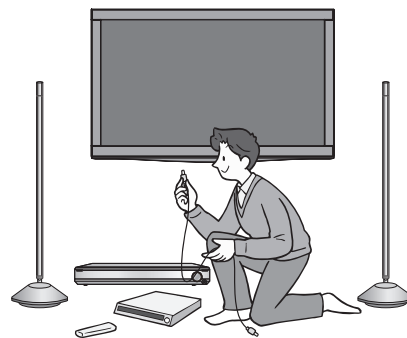

Setting up your Home Theater system

Step

1

Installing the speakers (→ page 8)

You can make your preferred setting because speaker cords are not required.

- Make sure to place the speakers on a flat, stable surface so there is no danger of them falling over.
- AC power supply cord (included) is necessary for each speaker.

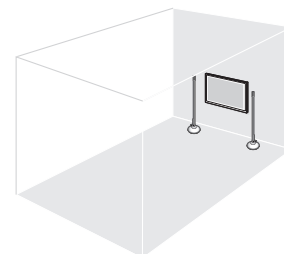

Step

2

Connecting the television and DVD recorder (→ page 9)

(Peripheral equipment and cables are not included unless otherwise mentioned.)

Install and connect the main unit and other equipment.

■ Connecting TV

Necessary cable:

(For images and audio) **HDMI cable: 1 (not included)**

■ Connecting recorder

Necessary cable:

(For images and audio) **HDMI cable: 1 (not included)**

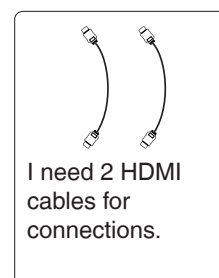

I need 2 HDMI cables for connections.

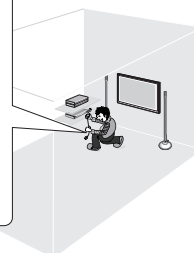

- Connect with an HDMI cable for high-quality audio and video.
- This connection requires HDMI terminals on both the television and the DVD recorder.

Step

3

Setting the speakers (→ page 13)

Use the remote control for speaker setting.

- Make sure to set the speakers when using for the first time after purchase.

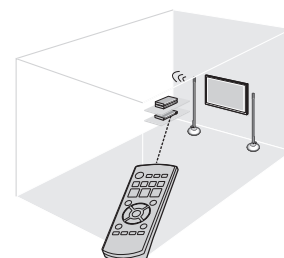

Step

4

Enjoying movies and music (→ page 16)

Enjoy surround sound with DVDs, TV, and other sources.

- Audio is transmitted wirelessly.

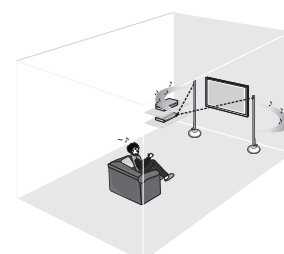

Supplied accessories

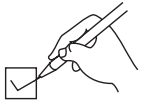

Please check and identify the supplied accessories.



Use numbers indicated in parentheses when asking for replacement parts.

(Product numbers correct as of January 2010. These may be subject to change.)

Only for U.S.A. and Puerto Rico: To order accessories, refer to "Accessory Purchases (United States and Puerto Rico)" on page 30.

Only for Canada:

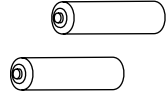
To order accessories, call the dealer from whom you have made your purchase.

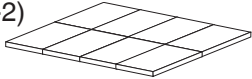
<input type="checkbox"/> 3 AC power supply cords (K2CB2CB00021) 	<input type="checkbox"/> 2 Batteries (R6, AA) 
<input type="checkbox"/> 1 Remote control (N2QAYB000417) 	<input type="checkbox"/> Leg cushions (1 sheets: 8 pieces) (RFA3045-2)  <p>Keep the Leg cushion out of reach of children to prevent swallowing.</p>

Packing plan

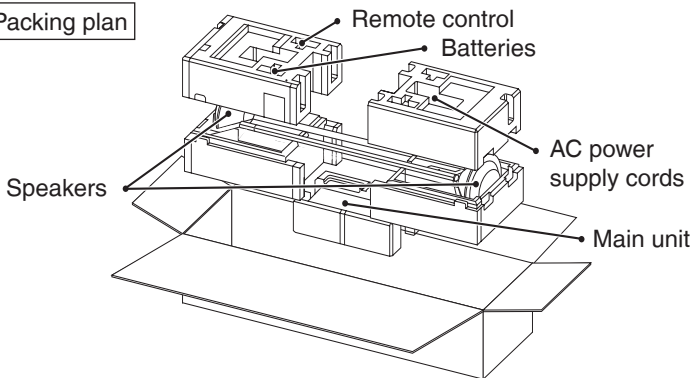

- When taking out speakers, hold the pole and base parts (→ page 6).

Control guide

Main unit (Control box)

Front view

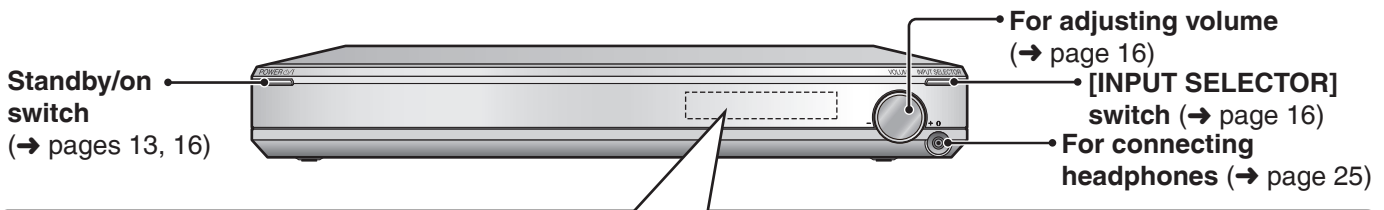

Display

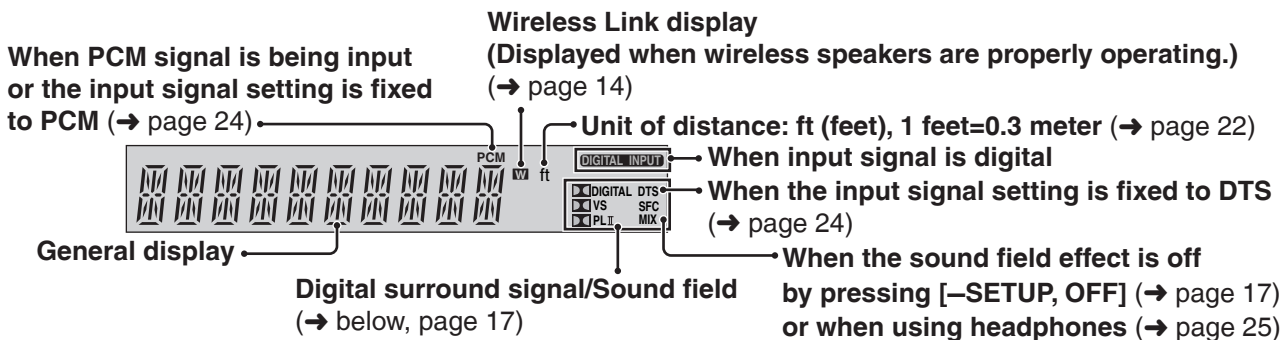

- DIGITAL** : Dolby Digital sources
- DTS** : DTS sources
- VS** : When Dolby Virtual Speaker is working
- SFC** : When SFC mode is being used

- PL II** : When Dolby Pro Logic II decoder is being used (When using Dolby Virtual Speaker for 2-channel stereo source)

Control guide

Rear view

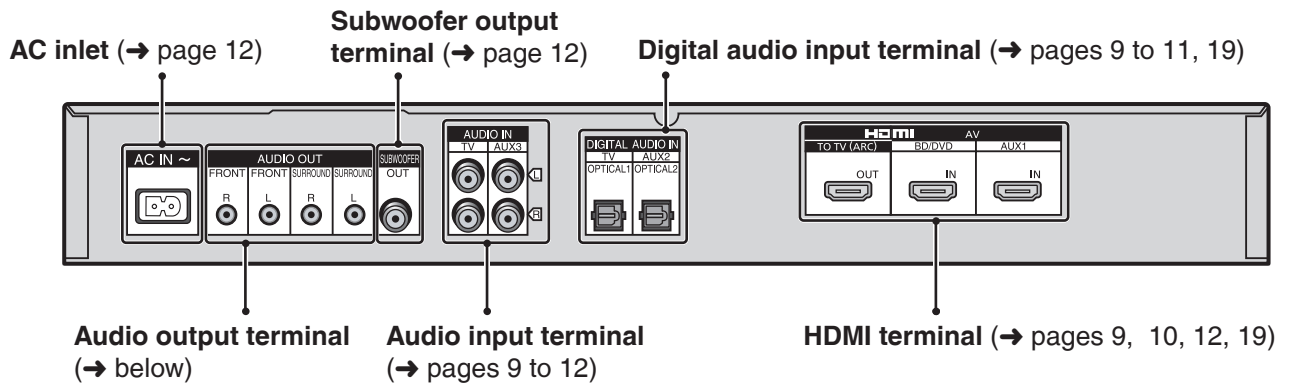

Control guide Before use

Note

The audio output terminals can be used when you do not use the wireless function and play back on other speakers via an external amplifier. Use commercially available monaural audio cables (monaural mini plug/pin plug) to connect to audio input terminals of an external amplifier channel by channel.

Saving energy

This system is designed to conserve its power consumption and save energy.

- **This system is automatically turned off** when no signal is input and no operation is performed for approx. 30 minutes.

Speaker (with built-in amplifier)

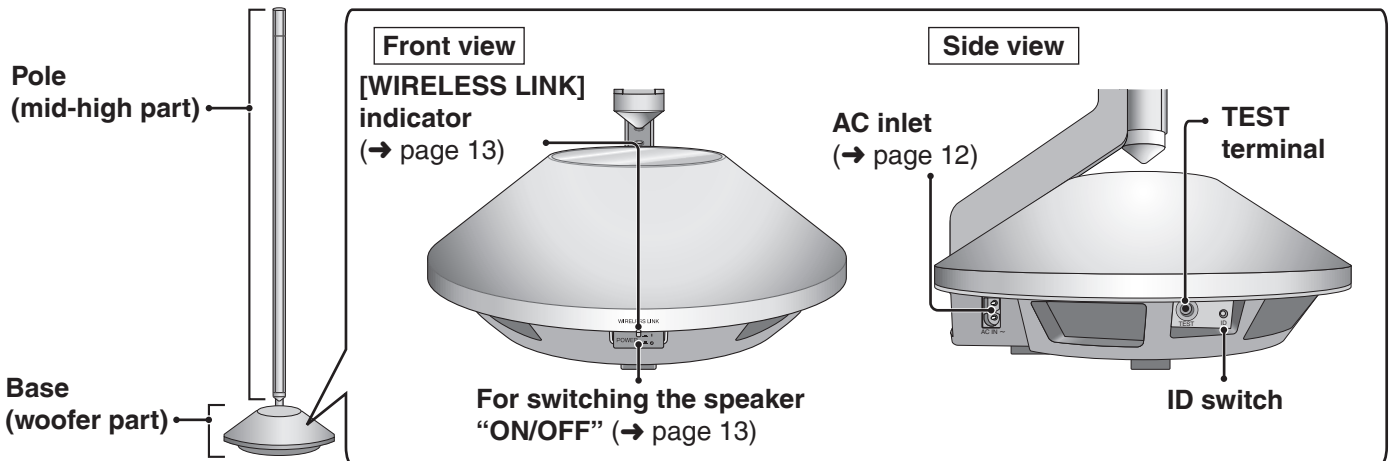

Note

TEST terminal: This is used to check the product operation status. Only used in factory. Do not insert a foreign object.
ID switch: This is used to check the product operation status and not used regularly.

Remote control

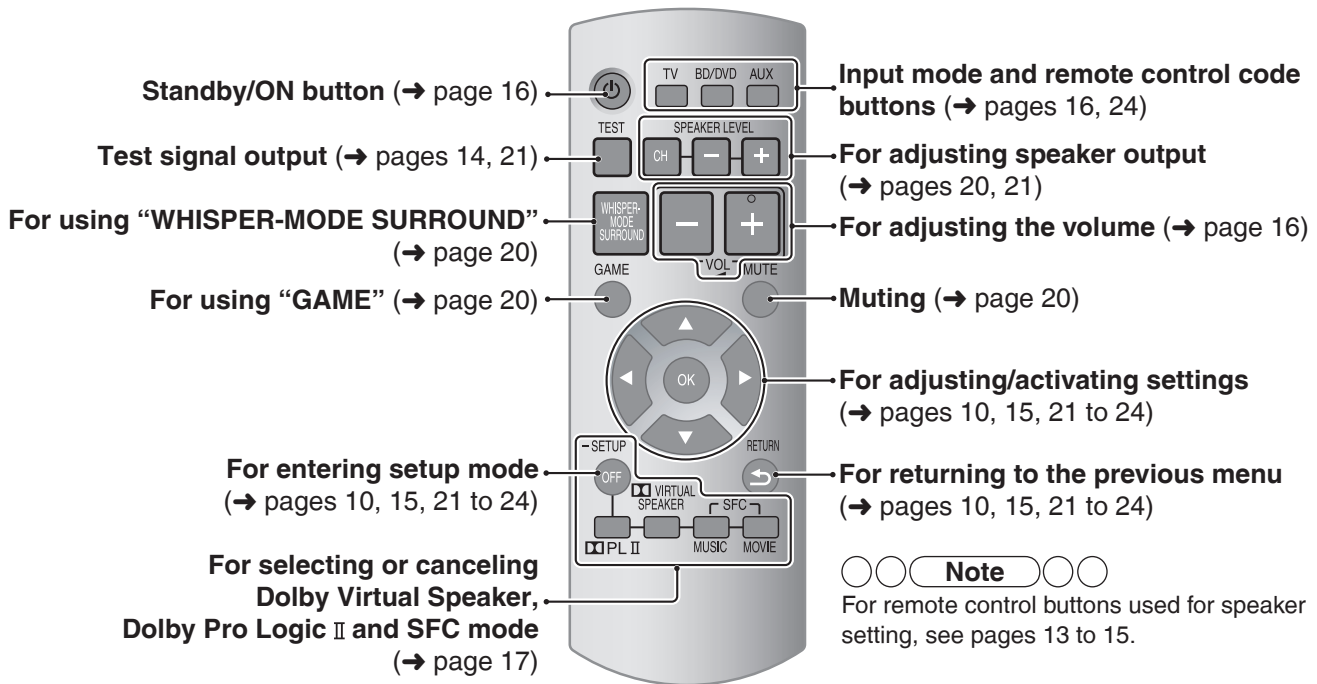

Remote control preparation

Inserting the batteries

Press on the tab to open.

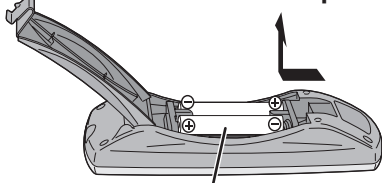

(R6/LR6, AA)

Insert so the poles (+ and -) match those in the remote control.
Use manganese batteries or alkaline batteries.

- Do not mix old and new batteries.
- Do not use different types of batteries at the same time.
- Do not take apart or short circuit.
- Do not attempt to recharge alkaline or manganese batteries.
- Do not use batteries if the covering has been peeled off.
- Do not heat or expose to flame.
- Do not leave the batteries in an automobile exposed to direct sunlight for a long period of time with doors and windows closed.

Mishandling of batteries can cause electrolyte leakage which can severely damage the remote control.
Remove the batteries if the remote control is not going to be used for a long period of time. Store them in a cool, dark place.

CAUTION

Danger of explosion if battery is incorrectly replaced. Replace only with the same or equivalent type recommended by the manufacturer. Dispose of used batteries according to the manufacturer's instructions.

Using the remote control

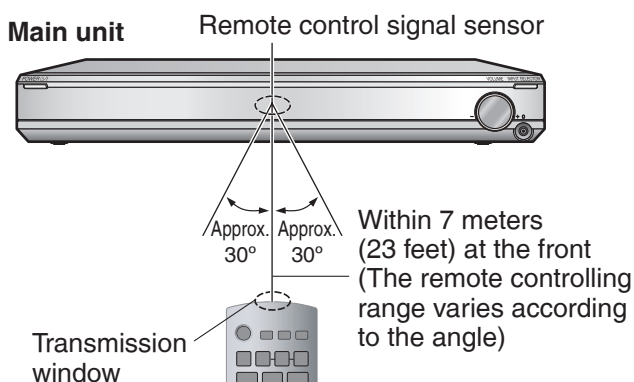

Note

- Do not place an object between the signal sensor and the remote control.
- Do not expose the signal sensor to direct sunlight or strong light of a fluorescent lamp.
- Keep the transmission window and the system's sensor free from dust.

Installation

Setup example

- Aim the front face (with Panasonic logo) of each speaker at the listening-viewing position for setting.

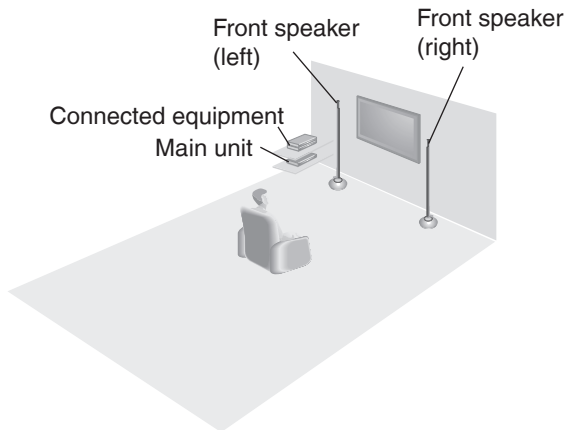

- There is no positional distinction for each speaker before setting.
- Make sure to place the speakers on a flat, stable surface so there is no danger of them falling over.
- When carrying speakers, hold the pole and base parts (→ page 6).
- The speakers of this system are not magnetically shielded.
Do not install this system near a CRT-based television.

Note

- Make sure the base parts are not covered by cloth such as a curtain.
- Before attaching the leg cushion (included) on the base parts to prevent tilt or rattle on the floor, make sure there are no people in the surrounding area.
- If the main unit is placed at the height of 50 cm (1.6 feet) or below from the floor, the radio waves reach a smaller range.
- Do not install other equipment directly on or under the main unit.

Wireless functions

As this system uses a frequency band of 2.4 GHz, the radio waves may be interrupted by an obstacle. Depending on the surrounding environment (i.e. radio wave interruption from outside, etc.) or the building structure where this system is used (i.e. wall that easily reflects radio waves, etc.), sounds may be cut or noise may occur.

Install this system properly paying attention to the following descriptions.

■ Equipment certification

As this system received Technical Conditions compliance certification based on the Radio Law, the wireless station license is not required. However, if you do the following actions to this system, you may be held accountable by law.

- **Disassemble or refurbish**

■ Restrictions for use

- Domestic use only.
- Use this system in the same room.

■ Do not place an obstacle between the main unit and speakers.

Radio waves from this system reach a maximum range of 15 m (49 feet) in the same room. If there is an obstacle between the main unit and speakers or the main unit is placed at the height of 50 cm (1.6 feet) or below from the floor, the radio waves reach a smaller range.

■ Keep this system away from equipment that generates radio wave interference.

If the following equipment is located near the system, install this system away from such equipment.

- **Bluetooth, OA devices, telephone, etc.: approx. 3 m (10 feet) or more.**
- **Microwave oven, wireless LAN compatible devices: approx. 3 m (10 feet) or more.**

This system is designed to automatically avoid radio wave interference with such household equipment. If radio wave interference occurs, the Wireless Link display (→ page 14) may blink, the sounds from speakers may be interrupted or noise may occur.

These phenomena occur when this system selects a proper frequency. These are not malfunctions.

■ Keep this system away from metal objects that tend to reflect radio waves.

If there are metal objects or furniture in the room where this system is installed, radio waves tend to be reflected. Depending on the listening-viewing position, sounds may be interrupted or noise may occur. These symptoms may be remedied by slightly moving this system's position.



Note that radio waves tend to be reflected also when this system is installed in rooms with a lot of activity.

Home Theater connections

- Turn off all equipment before making any connections.
- To connect equipment, refer to the appropriate operating instructions.

Basic connections

Connection cable

<p>HDMI cable (not included)</p> 	<p>Stereo connection cable (not included)</p> 	<p>Optical fiber cable (not included)</p> 
---	--	--

Connecting equipment with HDMI terminal (TV, DVD recorder, etc.)

Easy connection using ARC (Audio Return Channel) (below): The conventional setting has required 2 cables to connect this system and a TV: HDMI cable and optical fiber or stereo connection cable. Now, with the ARC technology, all you need is 1 HDMI cable to connect to an ARC compatible TV.

The recommended HDMI cable is ARC compatible.

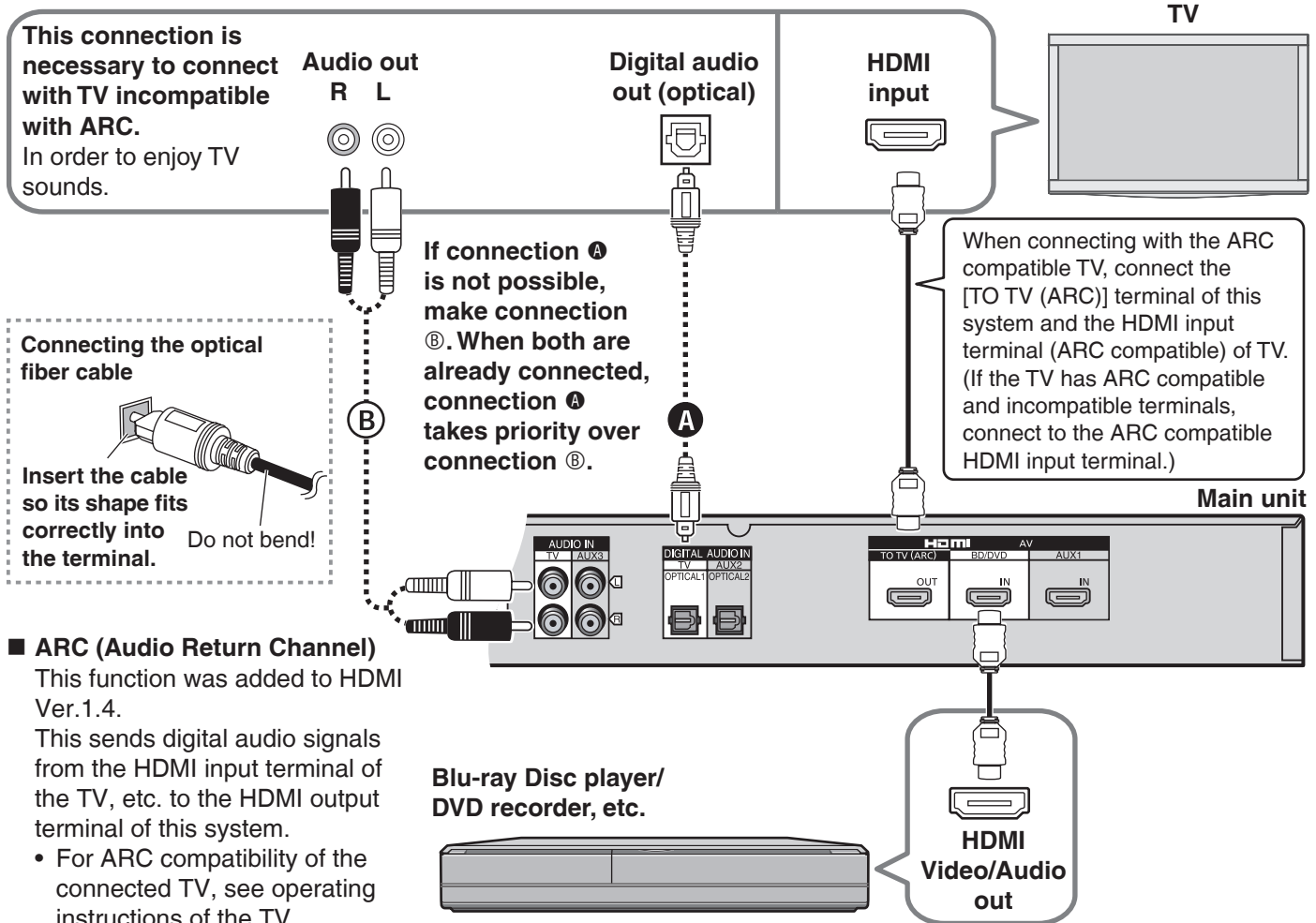

■ ARC (Audio Return Channel)

This function was added to HDMI Ver.1.4.

This sends digital audio signals from the HDMI input terminal of the TV, etc. to the HDMI output terminal of this system.

- For ARC compatibility of the connected TV, see operating instructions of the TV.

■ HDMI cable notes

- It is recommended that you use Panasonic's HDMI cables.
- Please use High Speed HDMI Cables that have the HDMI logo (as shown on the cover).
- Using the High Speed HDMI cable is recommended during 1080p output.

■ Enjoying only with TV speaker

- When image equipment such as TV and Blu-ray Disc player/DVD recorder, etc. is connected to the HDMI terminal (→ above, page 12) of this system, images/audio signals from the Blu-ray Disc player/DVD recorder, etc. go through this system and are transmitted to the TV even if this system is turned off using the power button of this system (**Standby through function**). This is convenient to enjoy only with the TV speaker.

○ ○ Note ○ ○

When you turn this system off using the power button of this system, the audio/video signals from equipment connected to HDMI input are output through the television, even if you have set input on this system to anything other than HDMI input ("**BD/DVD**" or "**AUX 1**") before turning off this system. (The selector returns to the previous setting when you turn this system on again.)

When equipment is connected to both BD/DVD IN terminal and AUX1 terminal, images/audio signals of equipment whose input is lastly selected are output.

Home Theater connections

Basic connections

Connecting STB etc.

Use this connection to enjoy STB multi-channel sources on this system.

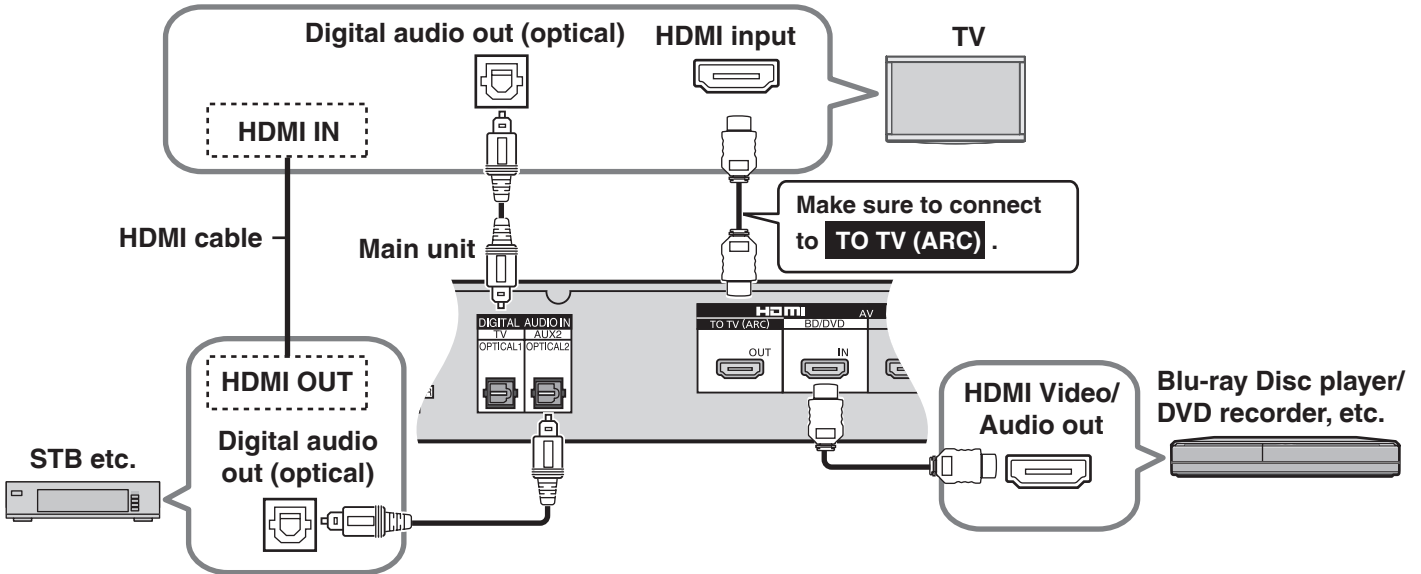

Setting for automatically switching the input source to STB

When you make the above connection and you use the Panasonic TV (VIERA), you can automatically switch this system's input by switching the input source of the TV (VIERA) to STB in the following procedure.

Preparation: Make sure that this system has been turned on. (→ page 16)



1. Switch the input source of TV (VIERA) with the above connection and show STB pictures.
2. Press and hold [-SETUP, OFF] for about 2 seconds.
The setting items are displayed. (→ page 21)
3. Press [◀][▶] to select "STB AUDIO" and press [OK].
4. Press [▲][▼] to select "SET" and press [OK].
SET: The setting is automatically switched to "AUX2 / STB".
OFF: The setting is not automatically switched to "AUX2 / STB". (factory setting)
5. Press [⇒ RETURN] several times to select "EXIT" and press [OK] to finish the setting.

To return to the previous display/To cancel during setting operation in steps 2 to 5: Press [⇒ RETURN].

○ ○ ○ Note ○ ○ ○

- "STB AUDIO" in step 3 is displayed only when the unit is connected to the Panasonic TV (VIERA). Also, this is not displayed when the step 1 operation is not performed.
- If you change the connection after setting, select "OFF" once and "SET" again.
- When you select "EXIT" and press [OK] in step 3, the setting mode finishes.

Connecting cables to audio terminals (DVD player, etc.)

- Refer to the operating instructions for the equipment you are connecting for the correct type of video cable.

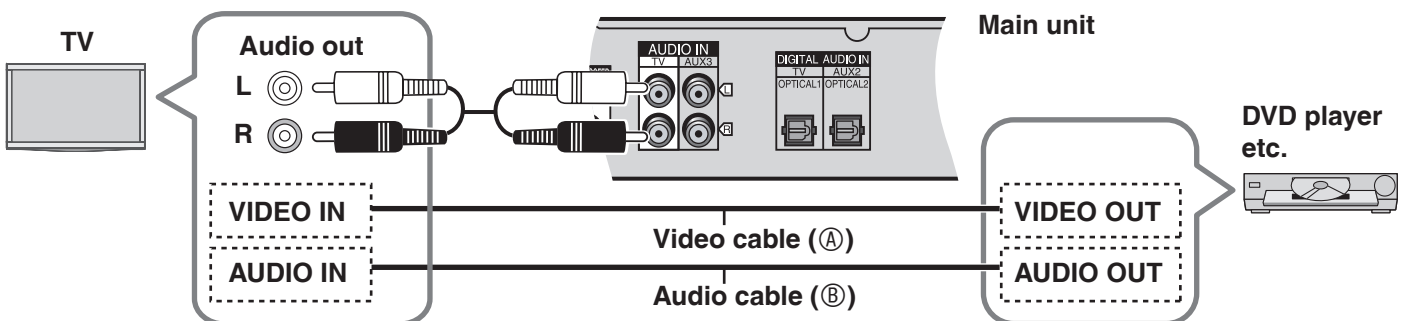

Ⓐ: Connect the video cable directly from the other equipment to the television.

Ⓑ: Use this connection so audio from the equipment can be heard through the television speakers even if this system is in Standby mode.

Reduce the volume on the television and select "TV" after you have made connections as above if you want to use this system.

- Turn off all equipment before making any connections.
- To connect equipment, refer to the appropriate operating instructions.

Connecting equipment without HDMI terminal (DVD player, VCR, etc.)

Connection cable

Optical fiber cable (not included)



Stereo connection cable (not included)



- For the correct type of video cable, refer to the operating instructions for the equipment you are connecting.

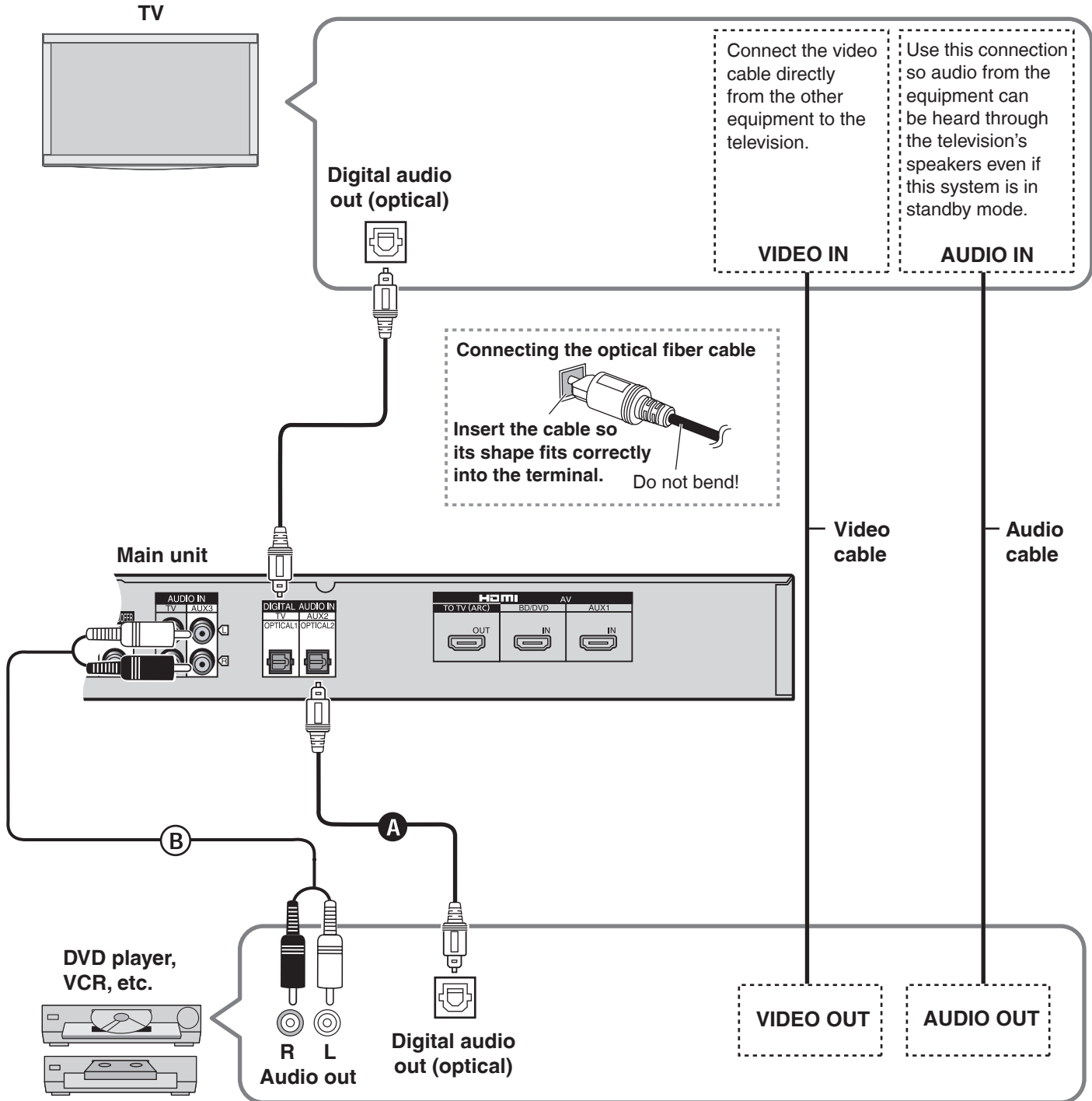

Make the connection either **A** or **B** according to the suitability for your equipment.

To connect a DVD recorder with built-in VCR

(When the DVD recorder has DVD output terminal and DVD/VHS output terminal, make the following connections.)

Make the above connection **A for DVD output terminal.**

Make the above connection **B for DVD/VHS output terminal.**

Home Theater connections

- Turn off all equipment before making any connections.
- To connect equipment, refer to the appropriate operating instructions.

Other connections

Connection cable

HDMI cable (not included)



Stereo connection cable (not included)



To connect a second set of equipment that supports HDMI

* See page 9 for connecting this system to TV.

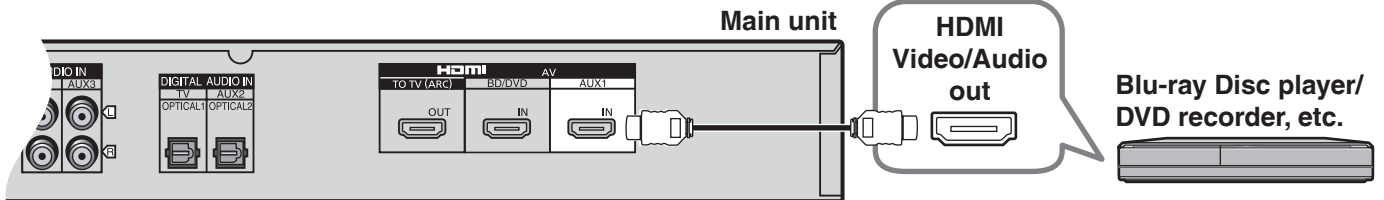

To connect audio equipment (CD player, etc.)

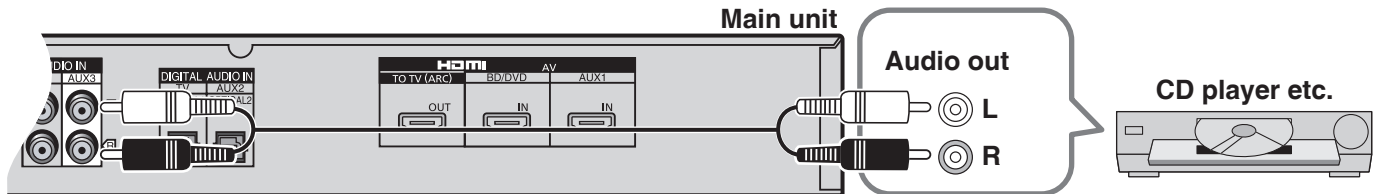

To connect a subwoofer (not included)

You can connect a commercially available active subwoofer (with built-in amplifier) (not included) to the subwoofer output terminal (→ page 6) if you want to enjoy deeper bass sounds.

Connection cable

Monaural connection cable (not included)



AC power supply connection

To save power when the system is not to be used for a long time, unplug it from the household AC outlet. Make sure to turn this system off before unplugging the AC power supply cord.

If you unplug the AC power supply cord without turning this system off, some of the settings may not be saved.

Main unit

Connect AC power supply cord after all other cables are connected.

This system consumes approx. 0.5 W when the AC power supply cord is connected to the household AC outlet (approx. 0.2 W in Standby condition (HDMI off mode) (→ page 22)).

AC power supply cord (included)

Household AC outlet (AC 120 V, 60 Hz)

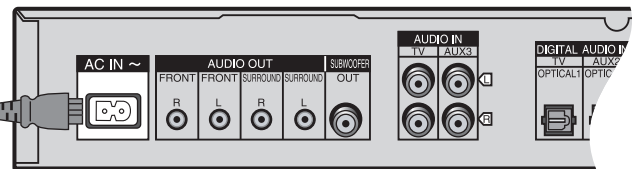
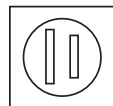

Speakers

For power consumption of speaker, see page 14.

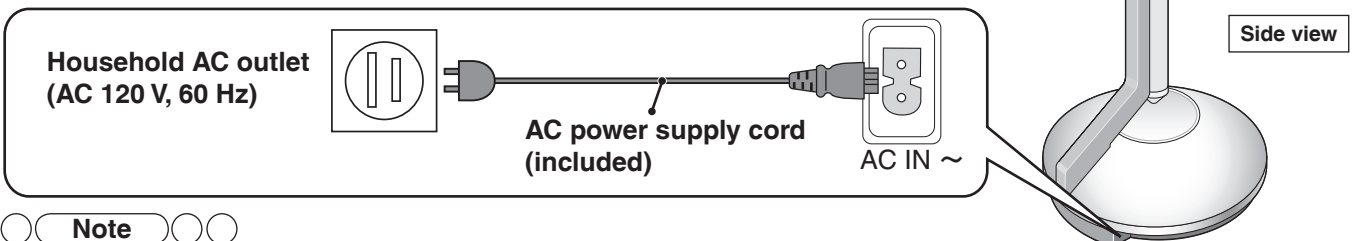

Note

- The included AC power supply cords are for use with this system only. Do not use them with other equipment. Also, do not use the AC power supply cord for other equipment with this system.

Speaker setting

Setting the speakers

Make sure to make this setting when using for the first time after purchase.

Preparations

■ **Make sure that all equipment has been turned off.**

(When the VIERA Link “HDAVI Control” compatible Panasonic TV (VIERA) and Blu-ray Disc player/DVD recorder (DIGA) are connected, do not turn on the TV (VIERA) and Blu-ray Disc player/DVD recorder (DIGA) until the setting is complete.)

■ **Connect the AC power supply cords of main unit and 2 speakers to household AC outlets.**
(→ page 12)

■ **Make sure that the main unit and speakers have been turned off.**

■ **Prepare the remote control. (→ page 7)**

1. Turn the main unit on.

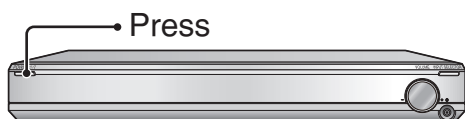

- “2CH SEARCH” appears on the display.
(This is displayed only at the first-time setting.)

2. Turn 2 speakers on.

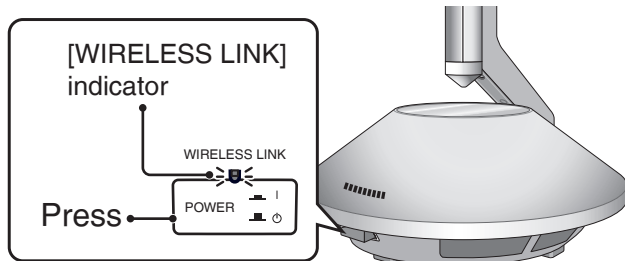

- The color of the [WIRELESS LINK] indicator changes from red to green.
- When the [WIRELESS LINK] indicator of each speaker lights green, “2CH SEARCH” display disappears.

👉 **When installing surround speakers**
See “Installing surround speakers” (→ page 14) and “Setting surround speakers” (→ page 15).

3. Press and hold [CH] on the remote control for about 3 seconds until “2 SPKR SET” is displayed on the main unit’s display.

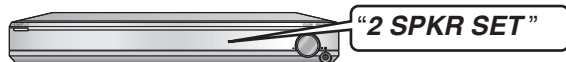

Always aim the remote control at the main unit for operation.

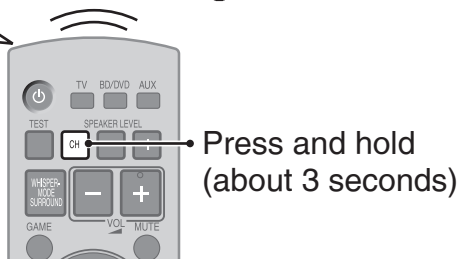

4. Press the remote control button corresponding to the speaker outputting the confirmation sound.

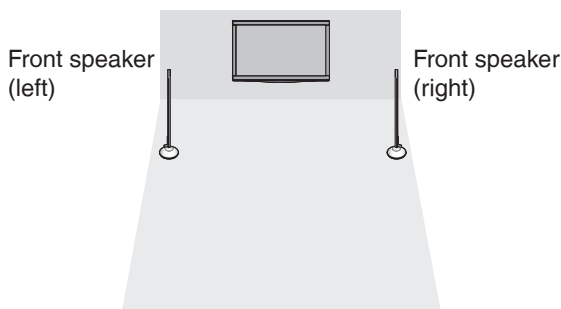

When the sound is output from the front speaker (left), press [GAME].

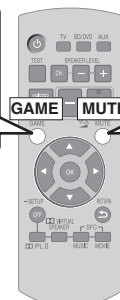

When the sound is output from the front speaker (right), press [MUTE].

- Sound is output from either of the speakers.
- When you press the button corresponding to the confirmation sound of a speaker, another speaker outputs the confirmation sound. Press the corresponding button in the same way and complete settings for the 2 speakers.
- When “COMPLETE” disappears from the main unit’s display, the speaker setting is complete.

Note

- Check if the speakers are properly set after setting the speakers. (→ page 14)
- If the speakers are set incorrectly in step 4, turn the main unit off then on again and perform steps 3 and 4.
- If the [WIRELESS LINK] indicator does not change from red to green, see page 27 of “Troubleshooting guide”.

Speaker setting

When the speakers are detected, the Wireless Link display lights up on the main unit's display. (Blinks during detecting operation.)

While the wireless speakers operate normally, the Wireless Link display lights, but when radio waves are interrupted (When speakers are in Standby condition, etc.), it blinks.

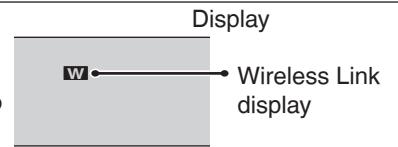

- When you turn the main unit off with the speakers on, the speakers automatically enter Standby (Wireless Link Standby). The color of the [WIRELESS LINK] indicator turns to red.
 - To reduce more of the power consumption of speakers in Standby, turn the speakers off. The speakers enter Standby (In Standby condition).
- <Power consumption of speakers in Standby>
 Wireless Link Standby: approx. 0.8 W (per 1 speaker)
 In Standby condition: approx. 0.1 W (per 1 speaker)

Checking the speaker setting

1. Turn the main unit on.
2. Press [TEST] on the remote control to output the test signal.

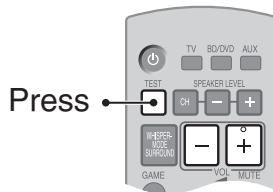

- To adjust the speaker volume, press [VOL ▲, ▼].

3. Make sure that the display of main unit matches speaker locations.

The test signal is output from one speaker at a time for about 2 seconds in the order shown below.

“TEST L” → “TEST R” → “TEST RS” * → “TEST LS” *

↑

- Confirm the correct setting locations in the following chart.

Display	Speaker outputting the test signal
TEST L	Front left
TEST R	Front right
TEST RS *	Surround right (right back)
TEST LS *	Surround left (left back)

* Displayed only when using the surround speakers.

○ ○ ○ Note ○ ○ ○

If the speakers are not properly set, do either of the following.

- Move the speakers according to the unit's display.
- Perform steps 3 and 4 of “Setting the speakers” (→ page 13). When using the surround speakers, perform steps 7 and 8 of “Setting surround speakers” (→ page 15).

4. Press [TEST] on the remote control to stop the test signal.

👉 If the speaker is repaired or replaced

Perform the above “Checking the speaker setting” to confirm that the speaker properly operates. Do the following operations if the sound is not produced normally:

1. Press and hold [INPUT SELECTOR] on the main unit about 3 seconds until “2CH SEARCH” is displayed.
2. Perform steps 2 to 4 of “Setting the speakers” (→ page 13).

Installing surround speakers

The surround speakers are not included.

You can enjoy more dynamic surround playback with this system by installing Panasonic surround speakers SB-ZT1/SB-ZT2.

Setup example

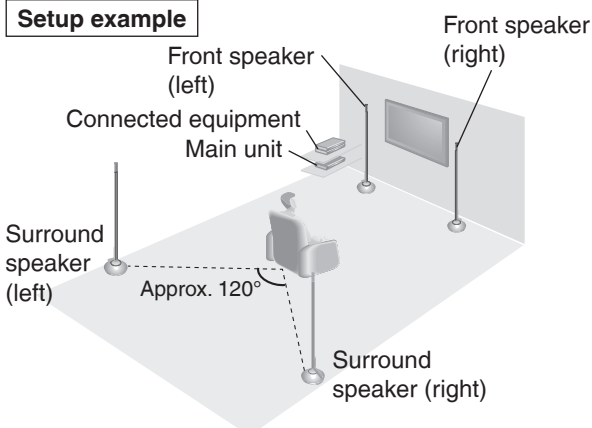

- The optional speakers can be purchased at the shop where you bought this system.
- Confirm the color of the front speaker before buying the optional speakers.
 When the front speaker is black: SB-ZT2PP-K
 When the front speaker is silver: SB-ZT1PP-S
- Place them slightly at the back right and left of the listening-viewing position.
- There is no positional distinction for each speaker before setting.
- Aim the front face (with Panasonic logo) of each speaker at the listening-viewing position for setting.

○ ○ ○ Note ○ ○ ○

Set the distance from each speaker to the listening-viewing position. (→ page 22)

Setting surround speakers

- Link the front speakers wirelessly first and then make the settings for the surround speakers.

Preparations

- Make sure that all equipment has been turned off.
(When the VIERA Link “HDAVI Control” compatible Panasonic TV (VIERA) and Blu-ray Disc player/DVD recorder (DIGA) are connected, do not turn on the TV (VIERA) and Blu-ray Disc player/DVD recorder (DIGA) until the setting is complete.)
- Connect AC power supply of main unit and 4 speakers to household main sockets. (→ page 12)
- Make sure that the main unit and speakers have been turned off.
- Prepare the remote control. (→ page 7)

1. Turn the main unit on.

2. Turn on the front speakers.

- The color of the [WIRELESS LINK] indicator of the front speaker changes from red to green.
- Do not turn on the surround speakers yet at this point. The color of the [WIRELESS LINK] indicator does not change from red to green even if the power is turned on.

3. Set “4CH” at the setting operation of “Changing the number of speakers to 4” below.

4. Turn the main unit off once.

5. Turn the main unit on again.

- “4CH SEARCH” appears on the display. (This is displayed only at the first-time setting.)

6. Turn on the surround speakers.

- The color of the [WIRELESS LINK] indicator of the surround speaker changes from red to green.
- When the [WIRELESS LINK] indicator of each speaker lights green, “4CH SEARCH” display disappears.

7. Press and hold [CH] on the remote control for about 3 seconds until “4 SPKR SET” is displayed on the main unit’s display.

- Always aim the remote control at the main unit for operation.

8. Press the remote control button corresponding to the speaker outputting the confirmation sound.

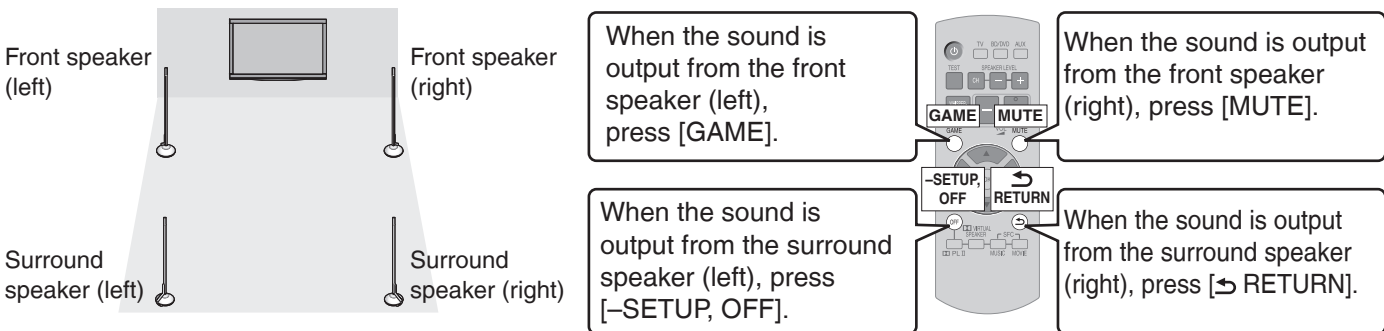

- Sound is output from any of the speakers.
- When you press the button corresponding to the confirmation sound of a speaker, another speaker outputs the confirmation sound. Press the corresponding button in the same way and complete settings for all 4 speakers.
- When “COMPLETE” disappears from the main unit’s display, the speaker setting is complete.

Note

- Check if the speakers are properly set after setting the speakers. (→ page 14)
- If the speakers are set incorrectly in step 8, turn the main unit off then on again and perform steps 7 and 8.
- If the [WIRELESS LINK] indicator does not change from red to green, see page 27 of “Troubleshooting guide”.

Changing the number of speakers to 4

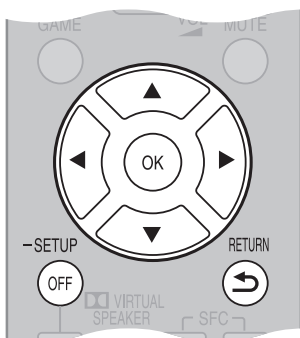

1. Press and hold [-SETUP, OFF] for about 2 seconds.

The setting items are displayed. (→ page 21)

2. Press [◀][▶] to select “SPEAKERS” and press [OK].

3. Press [▲][▼] to select “4CH” and press [OK].

2CH : When only front speakers are installed (factory setting)

4CH : When surround speakers are additionally installed

- When changing the number of speakers to 2, select “2CH” and press [OK].

4. Press [▲][▼] to select “YES” and press [OK].

- To cancel, select “NO”.

5. Press [RETURN] several times to select “EXIT” and press [OK] to finish the setting.

Note

When you select “EXIT” and press [OK] in step 2, the setting mode finishes.

- To return to the previous display/To cancel during setting operation: Press [RETURN].

Enjoying movies and music

Preparations

- Turn on the TV and switch its input to match the connection (HDMI, for example) using the TV remote control.
- Make sure that the speakers are on. (The following are operations when the power is on in Wireless Link Standby.)

Aim the remote control toward the signal sensor (→ page 7) on the main unit of this system.

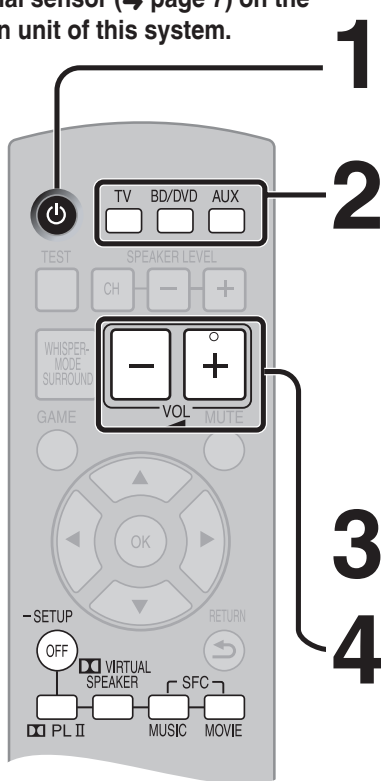

1 Press this button to turn on the system.

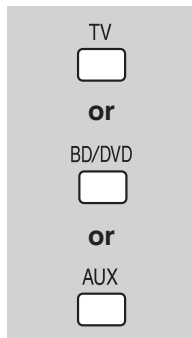

2 To select the source press one of these buttons.

- TV** : TV (optical, analog)
BD/DVD : Blu-ray Disc player/DVD recorder (HDMI)
AUX 1 : AUX1 terminal (HDMI)
AUX 2 : AUX2 terminal (optical)
AUX 3 : AUX3 terminal (analog)
 ■ **“AUX 1”, “AUX 2”, and “AUX 3”** switch every time you press [AUX].

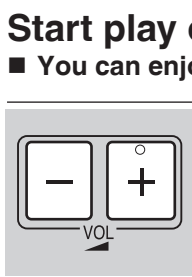

3 Start play on the connected equipment.

- You can enjoy a variety of surround effects. (→ page 17)

4 To adjust the volume press these buttons.

Adjustment range: **0** (Min) to **50** (Max)

- After playback, reduce the volume level and turn off.

Operation on the main unit

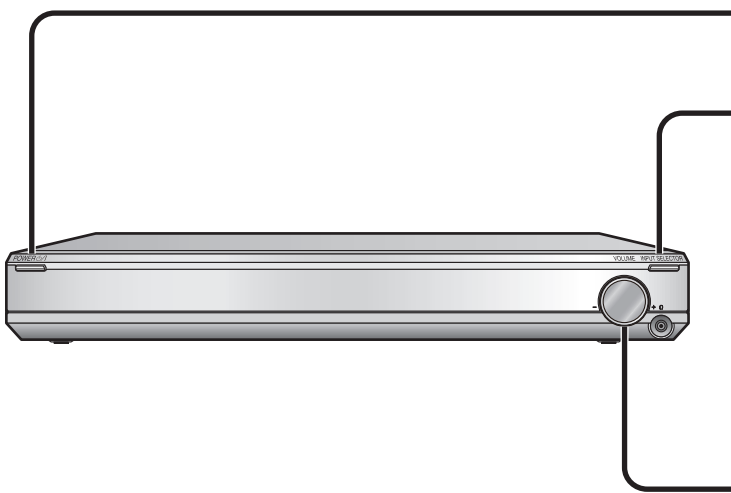

1 Turn on the system.

Press **POWER**

2 Select the source.

Press **INPUT SELECTOR**

(The input source switches each time you press the button.)

- TV** : TV (optical, analog)
BD/DVD : Blu-ray Disc player/DVD recorder (HDMI)
AUX 1 : AUX1 terminal (HDMI)
AUX 2 : AUX2 terminal (optical)
AUX 3 : AUX3 terminal (analog)

3 Start play on the connected equipment.

4 To adjust the volume.

Turn **VOLUME**

Note

- See page 27 for digital signals that can be played on this system.
- Depending on the playback signal, you may feel the volume of the bass or surround speakers is not balanced with the volume of the front speakers. In this case, you can adjust the speaker volume during playback. (→ page 20)
- Even if you switch input to “TV”, images (or audio) of the equipment connected to the BD/DVD IN terminal or AUX1 terminal are output from the TV OUT terminal. When the equipment is connected to both the BD/DVD IN terminal and AUX1 terminal, signals of equipment whose input is lastly selected are output.
- **When using a DVD recorder with built-in VCR (with the DVD output terminal and DVD/VHS output terminal mounted), select the input as follows in step 2 above.**
 To enjoy DVD (when connected to AUX2): select **“AUX 2”**.
 To enjoy video (when connected to AUX3): select **“AUX 3”**.

Enjoying sound field effects

Sound field effects differ depending on input sources. Select the mode you prefer after listening to the actual sound.

Dolby Virtual Speaker

You can enjoy surround effects as if you were listening to 5.1 channel sources. (Dolby Pro Logic II also works for stereo signals of video, CD, etc.)

■ Using Dolby Virtual Speaker

Press  • The mode switches each time you press the button. (→ below)

REFERENCE (Standard mode)	Standard sound effect.
WIDE (Wide mode)	Broadens the effect to the left and right.

SFC (Sound Field Control)

You can enjoy more dynamic and broader surround effects when using SFC with Dolby Digital, DTS and stereo signals (video, CD, etc.).

■ Using SFC (Sound Field Control)

You can enjoy by adding your favorite surround effect to the Dolby Virtual Speaker (→ above) effect.

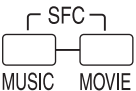
Press  • The mode switches each time you press the button. (→ below)

☞ To cancel SFC mode

Press 

MUSIC	
LIVE	Sound reflection and spread as if you were in a large concert hall.
POP/ROCK	Best suited for pop and rock music.
VOCAL	Enhance vocals.
JAZZ	Sound reflections as if you were in a small Jazz club.
DANCE	Sound spread echoing in a large space such as a dance hall.
MOVIE	
NEWS	Best suited for dialogs in news and drama movies.
ACTION	Best suited for action movies with impact.
STADIUM	Enjoy the feeling of being at a live sporting event.
MUSICAL	Enjoy the feeling of being at a live musical performance.
GAME	Enjoy games with greater audio impact.
MONO	Enjoy older monaural audio movies.

Canceling sound field effects

Press  -SETUP

- The surround effects disappear for 2-channel sources such as CD and TV.
- When the input signals are multi-channel LPCM or surround digital signals such as Dolby Digital or DTS, those signals are converged and are output from the left and right front speakers. When you use surround speakers, the surround playback (→ below) is achieved.
- The condition before the sound field effect is canceled is restored when you turn the unit off/on, switch input sources or plug/unplug the headphones.

When connecting the surround speakers

Surround playback

Multi-channel signals are distributed to the left and right front speakers, and the left and right surround speakers to output.

SFC (Sound Field Control) (→ left)

■ Using SFC (Sound Field Control)

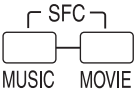
Press  • The mode switches each time you press the button. (→ left)

☞ To cancel SFC mode

Press [-SETUP, OFF]. (→ above)

Dolby Pro Logic II

You can enjoy 2-channel sources such as CD with the surround effect.



■ Using Dolby Pro Logic II

Press 

☞ To cancel sound field effects

Press [-SETUP, OFF]. (→ above)

○ ○ ○ Note ○ ○ ○

- See page 5 about how to display the surround digital signal/sound field.
- If the input signal is 2-channel, Dolby Virtual Speaker also works in conjunction by pressing [ PL II]. (Only when not connecting the surround speakers)
- You cannot use Dolby Virtual Speaker, Dolby Pro Logic II and SFC when the source contains PCM signals with sampling frequencies of over 48 kHz. They are automatically canceled if those signals are input. To use the effect when playing back other sources, press [ VIRTUAL SPEAKER], [ PL II] or [SFC MUSIC, MOVIE] again to select.
- You can also press [GAME] on the remote control to select "GAME" mode (→ left) of SFC. (→ page 20)
- When using the surround speakers, Dolby Pro Logic II cannot be used for surround signals such as Dolby Digital and DTS, and multi-channel LPCM signals.
- When playing back 7.1-channel LPCM signals, you can enjoy wider sound field effects as if another speaker is added. You can make the setting without using this effect. (→ page 22)

Using the VIERA Link “HDAVI Control™”

What is VIERA Link “HDAVI Control” ?

VIERA Link™ is a new name for EZ Sync™.

VIERA Link “HDAVI Control” is a convenient function that offers linked operations of this system, and a Panasonic TV (VIERA) or Blu-ray Disc player/DVD recorder (DIGA) under “HDAVI Control”. You can use this function by connecting the equipment with the HDMI cable. See the operating instructions for connected equipment for operational details.

- VIERA Link “HDAVI Control”, based on the control functions provided by HDMI which is an industry standard known as HDMI CEC (Consumer Electronics Control), is a unique function that we have developed and added. As such, its operation with other manufacturers’ equipment that supports HDMI CEC cannot be guaranteed.
- **This system supports “HDAVI Control 4” function.**
“HDAVI Control 4” is the newest standard (current as of January, 2010) for Panasonic’s HDAVI Control compatible equipment. This standard is compatible with Panasonic’s conventional HDAVI equipment.
- Please refer to individual manuals for other manufacturers’ equipment supporting VIERA Link function.

What you can do with VIERA Link “HDAVI Control”

Use the remote control of TV (VIERA) for operation. Operations differ depending on the type of TV.

- The following illustrations and displays are examples, which may differ from the actual product.
- When you do operations other than the following, use this system’s remote control.
- See operating instructions of the TV (VIERA) as well.

1. You can select “Speaker Selection” (“Home Cinema” or “TV”).

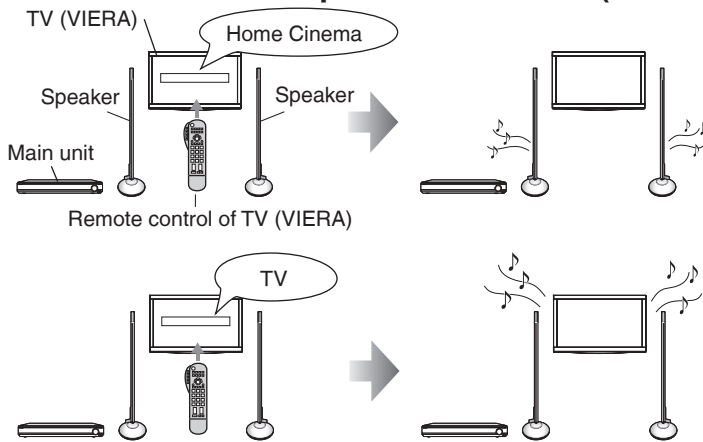

When audio is input, the main unit will be automatically turned on if it is in Standby* mode and the sound is output from this system’s speakers. You can also adjust the volume level by using the volume control buttons.

* “Standby” condition means the condition that the main unit is off.

TV (VIERA) speakers become active. When using with the Panasonic TV (VIERA) supporting HDAVI Control 4 or later version, the main unit is automatically turned off. (Intelligent Auto Standby) See operating instructions for the TV (VIERA) as well.

2. When you switch off the TV (VIERA), the main unit automatically turns off.

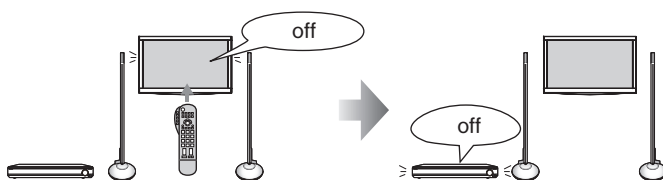

When the VIERA Link “HDAVI Control” compatible Blu-ray Disc player/DVD recorder (DIGA) is connected with an HDMI cable, the Blu-ray Disc player/DVD recorder (DIGA) also turns off.

Note

- When using with the Panasonic TV (VIERA) supporting HDAVI Control 4 and later version, when the main unit is turned on, the TV (VIERA) is set to “Home Cinema”.
- When using with the Panasonic TV (VIERA) supporting HDAVI Control 3 and older version, when the main unit is turned on, “**TV SPEAKER**” is displayed and audio is output from the TV (VIERA).
- When using with the Panasonic TV (VIERA) supporting HDAVI Control when the main unit is turned off, the TV (VIERA) is set to “TV”.
- If you perform operations such as selecting a channel on the remote control of the TV (VIERA), this system’s input is switched to “TV”.
- When you play back the Blu-ray Disc player/DVD recorder (DIGA) etc. connected to the BD/DVD IN terminal or AUX1 terminal, this system’s input is automatically switched to “**BD/DVD**” or “**AUX 1**”.



For correct use of VIERA Link “HDAVI Control”

Use the TV (VIERA) remote control to select “Home Cinema” without turning on the main unit with this system’s power button (including the remote control). (The main unit is automatically turned on.)

- See operating instructions of the TV (VIERA) as well.

Connection

Connect this system with VIERA Link “HDAVI Control” compatible TV (VIERA) and DIGA Blu-ray Disc player/DVD recorder (DIGA) with an HDMI cable.

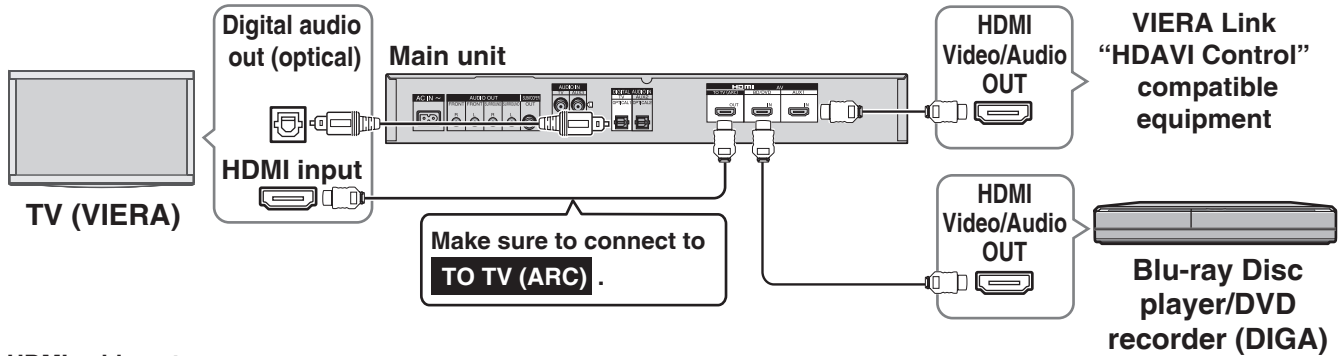

HDMI cable notes

- Please use High Speed HDMI Cables that have the HDMI logo (as shown on the cover).
- Using the High Speed HDMI cable is recommended during 1080p output.
- It is recommended that you use Panasonic’s HDMI cables. (Non-HDMI-compliant cables cannot be utilized.)
Recommended part number: RP-CDHS15 (1.5 m / 4.9 ft.), RP-CDHS30 (3.0 m / 9.8 ft.) RP-CDHS50 (5.0 m / 16.4 ft.) etc.

Note

- Only with the HDMI cable connection, you cannot enjoy TV (VIERA) sounds on this system. Connect the TV (VIERA) to this system with the optical fiber cable (or stereo connection cable) to enjoy TV (VIERA) sound.
- See the operating instructions for the TV (VIERA) for VIERA Link “HDAVI Control” operation of connected equipment.

Setup

Preparations: Check that the “VIERA Link “HDAVI Control” setting” (→ page 23) of this system is “ON”.
Make the setting to activate the VIERA Link “HDAVI Control” function in the menu operation of the TV (VIERA).

1. Turn on all equipment other than the TV.
2. Turn on the TV (VIERA).
3. Switch TV (VIERA) input to the HDMI terminal that this system is connected to.
4. Ensure that pictures from the Blu-ray Disc player/DVD recorder (DIGA), etc. are shown correctly after this system’s input is switched to “BD/DVD” or “AUX 1”.

Note

Make this setting in the following cases:

- when this system is connected for the first time after purchase
- when adding or reconnecting equipment
- when changing the settings for “Reducing Standby power consumption (In Standby condition (HDMI off mode))” (→ page 22) and “VIERA Link “HDAVI Control” setting” (→ page 23)

When not using this function

Set “VIERA Link “HDAVI Control” setting” to “OFF”. (→ page 23)

Functions and settings

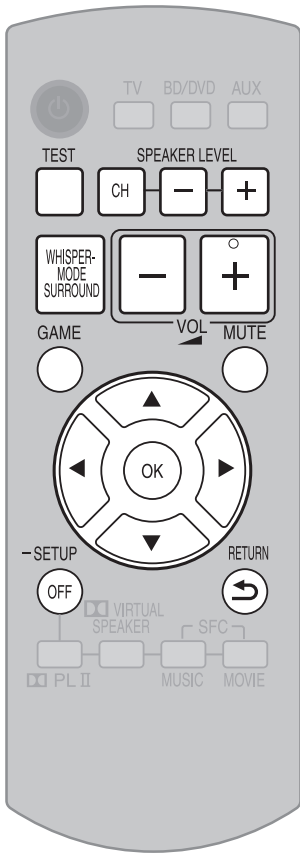

To return to the previous display/
To cancel during setting operation
(→ page 21): Press [↵ RETURN].

Using “WHISPER-MODE SURROUND”

This function is effective during surround playback only. You can enjoy the dynamic effect even if the sound volume level is low during surround playback.

Press [WHISPER-MODE SURROUND] to select “W.S. ON”.

- The current setting is displayed first.

Each time you press, the setting switches between “W.S. OFF” and “W.S. ON”.

■ **To cancel** Press [WHISPER-MODE SURROUND] to select “W.S. OFF”.

○ ○ **Note** ○ ○

WHISPER-MODE SURROUND is not effective in the following cases.

When not using the surround speakers:

When Dolby Virtual Speaker is off.

When using the surround speakers:

When Dolby Pro Logic II and SFC are off with 2-channel signal input.

If the above setting is made when this function is on, this function temporarily becomes off.

Using “GAME”

Enjoy gaming with more dynamic sound.

Press [GAME].

- “GAME” mode (→ page 17) in SFC is selected.

■ **To cancel** Press again.

If canceled, SFC’s effect itself is canceled.

Muting

“MUTE” blinks on the display while the volume is muted.

Press [MUTE].

■ **To cancel** Press again.

○ ○ **Note** ○ ○

- Muting is canceled when you switch the system to Standby.

- Muting is also canceled when you adjust the volume.

Adjusting the bass (woofer part) output

When you feel the bass volume is not balanced with the volume of the front speakers, you can adjust the bass during playback.

1. Press [CH] to select “WFR”.

(The speaker is switched each time you press the button.)

WFR (woofer) → **RS** (surround right) (when used) → **LS** (surround left) (when used)

2. Press [SPEAKER LEVEL +, -] to adjust the bass volume.

Adjustment range: **MIN, 1 to 15, MAX**

Adjusting the surround speaker output

When using the surround speakers, you can adjust them, too.

1. Press [CH] to select “RS” or “LS”.

(The speaker is switched each time you press the button.)

WFR (woofer) → **RS** (surround right) (when used) → **LS** (surround left) (when used)

2. Press [SPEAKER LEVEL +, -] to adjust the volume of each speaker.

Adjustment range: **-10 to +10**

■ **Repeat steps 1 and 2 to adjust the level of each speaker.**

○ ○ **Note** ○ ○

- You cannot adjust the front speakers with this operation. To adjust the volume balance of left and right front speakers, see “Adjusting the volume balance of front speakers”. (→ page 21)
- If the sound is distorted, lower the level.
- You cannot adjust the output level of speakers if the sound field effect is off and the speaker’s audio output is set to off. (→ page 17)
- You can adjust the speaker’s output level in each SFC mode respectively. (→ page 17)
- When a commercially available active subwoofer is connected to the subwoofer output terminal on this unit’s rear panel, the subwoofer is synchronized with the unit and the sound volume is adjusted.

Adjusting the surround speaker output using the test signal

You can make this setting when using the surround speakers. You can adjust the surround speaker volume by outputting the test signal.

1. Press [TEST] to output the test signal.

Speaker display

L : Front left, **R** : Front right,

RS : Surround right, **LS** : Surround left

- The test signal is output from one speaker at a time for two seconds in the following order.

TEST L → TEST R → TEST RS → TEST LS

2. Press [VOL ▲, ▼] to adjust the volumes of front speakers to the normal listening level.

Adjustment range: **0** (Min) to **50** (Max)

3. Press [CH] to select surround speakers for adjustment.

4. Press [SPEAKER LEVEL +, -] to adjust each speaker's output level.

Adjustment range: **RS, LS** : **-10** to **+10**

- The test signal comes from the speaker being adjusted.
- The test signal is output again in the above order 2 seconds after adjustment.

■ Repeat steps 3 and 4 to adjust the level of each speaker.

5. Press [TEST] to stop the test signal.

○ ○ **Note** ○ ○

- You can check the audio output of the front speakers. (→ page 14) (When the surround speakers are not used, only "TEST L" and "TEST R" are displayed and the test signal is output alternately.)
- To adjust the volume balance of left and right front speakers, see "Adjusting the volume balance of front speakers" (→ right).
- Even if you adjust each channel level in this adjustment, each channel level setting in each SFC mode (→ page 17) does not change.
- When you make this adjustment while using the front speakers only, Dolby Virtual Speaker functions. When playing 2-channel sources, Dolby Pro Logic II also works in conjunction. (→ page 17)
- To adjust the bass volume, do not output the test signal for adjustment. (→ page 20)

Setup menu items

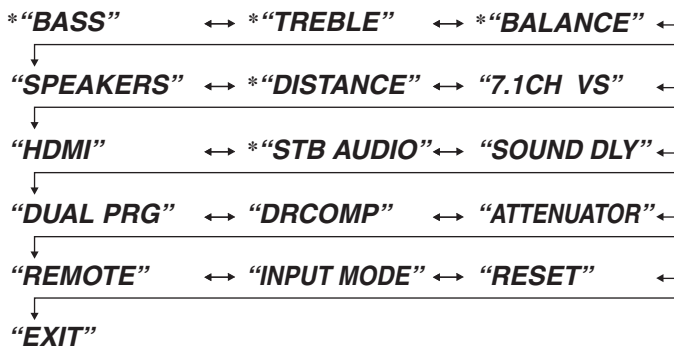

- * appears only when audio adjustment can be made.
- Select "EXIT" and press [OK] to finish the setup mode.

Adjusting sound quality

You can adjust the level of bass and treble.

This setting is effective only when you perform stereo playback of 2-channel analog and PCM signals (during Dolby Virtual Speaker and Dolby Pro Logic II is off).

This setting is not displayed in other conditions. Be sure to make this setting in the above condition.

1. Press and hold [-SETUP, OFF] for about 2 seconds.

The setting items are displayed. (→ above)

2. Press [◀][▶] to select "BASS" or "TREBLE" and press [OK].

3. Press [▲][▼] for adjustment, and press [OK].

Adjustment range: **-6** to **+6**

Factory setting: **0**

4. Press [↵ RETURN] several times to select "EXIT" and press [OK] to finish the setting.

Adjusting the volume balance of front speakers

You can adjust the balance of the front speakers.

1. Press and hold [-SETUP, OFF] for about 2 seconds.

The setting items are displayed. (→ above)

2. Press [◀][▶] to select "BALANCE" and press [OK].

3. Press [◀][▶] for adjustment, and press [OK].

L : Front left

R : Front right

Move the bar to left and right on the display to adjust.

- As the bar gets closer to "L", the sound moves to left front.
- As the bar gets closer to "R", the sound moves to right front.

4. Press [↵ RETURN] several times to select "EXIT" and press [OK] to finish the setting.

○ ○ **Note** ○ ○

- The bar indication is approximate.
- When using headphones, you cannot adjust the volume balance.

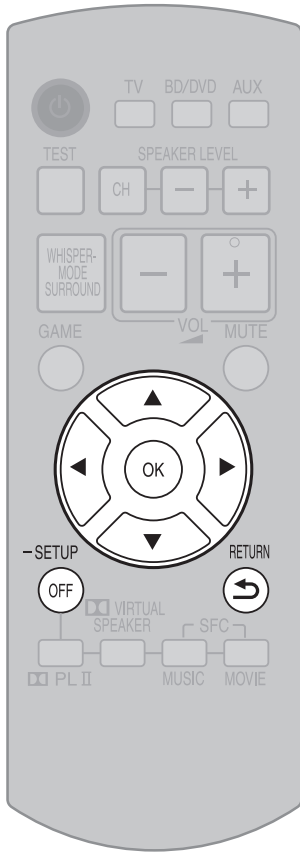

To return to the previous display/
To cancel during setting operation:
Press [↵ RETURN].

Setting distances

You can make this setting when using the surround speakers.
This setting is not displayed under different conditions.

By setting the distance from front/surround speakers to the listening-viewing position, the sound delay time is automatically calculated and adjusted so that sound reaches the listener at the same time.

1. Press and hold [-SETUP, OFF] for about 2 seconds.

The setting items are displayed. (→ page 21)

2. Press [◀][▶] to select “DISTANCE” and press [OK].

3. Press [◀][▶] to select a speaker to set and press [OK].

FRONT : Front speakers

SURR : Surround speakers

4. Press [▲][▼] to select the distance and press [OK].

Adjustment range: 1.0 to 10.0 meter (**3.0** to **30.0** ft (feet))

Factory setting: Front 3.0 meter (**10.0** ft (feet))

Surround 1.5 meter (**5.0** ft (feet))

5. Press [↵ RETURN] several times to select “EXIT” and press [OK] to finish the setting.



Radio waves from this system reach the maximum range of 15 m (49 feet) within the same room.

Setting 7.1-channel virtual surround

When playing back 7.1-channel LPCM signals, you can enjoy wider sound field effects as if another speaker is added. Factory setting is “**AUTO**”.

When you do not want to use 7.1-channel virtual surround effect, select “**OFF**” in this setting.

1. Press and hold [-SETUP, OFF] for about 2 seconds.

The setting items are displayed. (→ page 21)

2. Press [◀][▶] to select “7.1CH VS” and press [OK].

3. Press [▲][▼] to select “OFF” and press [OK].

AUTO : The setting is switched between ON and OFF depending on the input signals.

Only when 7.1-channel LPCM signals are input, 7.1-channel virtual surround is ON (When other signals are input, this setting is OFF).

OFF : 7.1-channel virtual surround is always OFF.

Factory setting: **AUTO**

4. Press [↵ RETURN] several times to select “EXIT” and press [OK] to finish the setting.

Reducing Standby power consumption (In Standby condition (HDMI off mode))

Standby through function (→ pages 9, 28) does not work in this mode if you have connected through the HDMI terminal.

VIERA Link “HDMI Control” (→ page 18) will not function when this system is off.

1. Press and hold [-SETUP, OFF] for about 2 seconds.

The setting items are displayed. (→ page 21)

2. Press [◀][▶] to select “HDMI” and press [OK].

3. Press [◀][▶] to select “STNBY” and press [OK].

4. Press [▲][▼] to select “OFF” and press [OK].

OFF : Standby power consumption reduced (approx. 0.2 W)

ON : “Standby through” is activated when this system is turned off. (Normal power consumption)

Factory setting: **ON**

5. Press [↵ RETURN] several times to select “EXIT” and press [OK] to finish the setting.

VIERA Link “HDAVI Control” setting

When you do not wish to use VIERA Link “HDAVI Control” (→ page 18), you can set the unlinked operation by selecting “OFF”.

The normal setting is “ON” (Linked operation).

1. Press and hold [–SETUP, OFF] for about 2 seconds.

The setting items are displayed. (→ page 21)

2. Press [◀][▶] to select “HDMI” and press [OK].
3. Press [◀][▶] to select “CTRL” and press [OK].
4. Press [▲][▼] to select “ON” or “OFF” and press [OK].

ON : When the operation is linked

OFF : When the operation is not linked

Factory setting: ON

5. Press [↵ RETURN] several times to select “EXIT” and press [OK] to finish the setting.



- When “CTRL OFF” is set, the ARC function will be disabled. Be sure to make the optical digital connection or analog connection. (→ page 9)

Adjusting the time lag between audio and video by delaying audio output

You can reduce audio and video time lag by adjusting sound delay.

1. Press and hold [–SETUP, OFF] for about 2 seconds.

The setting items are displayed. (→ page 21)

2. Press [◀][▶] to select “SOUND DLY” and press [OK].
3. Press [▲][▼] to select the setting and press [OK].

AUTO, OFF, 10, 20, 30, 40, 60, 80, 100, 120, 140, 160, 180, 200

Factory setting: AUTO

4. Press [↵ RETURN] several times to select “EXIT” and press [OK] to finish the setting.



- If delaying audio output is not necessary, select “OFF”.
- “AUTO” is effective only when connecting the Panasonic TV (VIERA) supporting HDAVI Control 3 and later versions. (Auto Lip Synchronization Function)
- When you connect the Panasonic TV incompatible with HDAVI Control 3 and later versions or non-Panasonic TV, if “AUTO” is set, “40” (msec) is set.

Switching between dual sounds

You can switch between dual sounds of Dolby Digital signals.

1. Press and hold [–SETUP, OFF] for about 2 seconds.

The setting items are displayed. (→ page 21)

2. Press [◀][▶] to select “DUAL PRG” and press [OK].
3. Press [▲][▼] to select the audio and press [OK].

MAIN : Main audio SAP : Sub channel audio output

M+S : Main + Sub channel audio output

Factory setting: MAIN

4. Press [↵ RETURN] several times to select “EXIT” and press [OK] to finish the setting.

Clear audio at low volume

Dynamic range compression function for Dolby Digital.

It compresses the dynamic range so that you can still hear dialog and leave the sound field unaffected.

Use this function when you have to turn the volume down, such as late at night.

1. Press and hold [–SETUP, OFF] for about 2 seconds.

The setting items are displayed. (→ page 21)

2. Press [◀][▶] to select “DRCOMP” and press [OK].
3. Press [▲][▼] to select the setting and press [OK].

OFF : Normal playback

STANDARD : The best suited playback for each audio source

MAX : Always compressed at the maximum level

Factory setting: OFF

4. Press [↵ RETURN] several times to select “EXIT” and press [OK] to finish the setting.

Switching the attenuator

Switch the attenuator “ON” when big sounds become distorted while playing an analog input source.

1. Press and hold [–SETUP, OFF] for about 2 seconds.

The setting items are displayed. (→ page 21)

2. Press [◀][▶] to select “ATTENUATOR” and press [OK].
3. Press [▲][▼] to select “ON” and press [OK].

ON, OFF

Factory setting: OFF

4. Press [↵ RETURN] several times to select “EXIT” and press [OK] to finish the setting.



To return to the previous display/
To cancel during setting operation:
Press [↵ RETURN].

Switching the input signal detection setting

Most sources can be played with “**AUTO**” (factory setting).

However, in the following cases, change the input signal detection setting.

- When the beginning of the song is cut during playback of CD, set to “**PCM**” (PCM FIX).
- When the signal is not detected during playback of DTS sources, set to “**DTS**” (DTS FIX).
- When noise occurs, return the setting to “**AUTO**”.

1. Press and hold [–SETUP, OFF] for about 2 seconds.

The setting items are displayed. (→ page 21)

2. Press [◀][▶] to select “**INPUT MODE**” and press [OK].

3. Press [◀][▶] to select the input and press [OK].

Input: **TV, DVD, AUX1, AUX2**

4. Press [▲][▼] to select the detection method of input signal and press [OK].

AUTO : Automatic detection

PCM : PCM (from CDs) digital input fixed

DTS : DTS digital input fixed

Factory setting: **AUTO**

- Repeat steps 3 and 4 to change setting.

5. Press [↵ RETURN] several times to select “**EXIT**” and press [OK] to finish the setting.

Reset (factory settings)

The operation settings for the system will be initialized to the settings made at the time of shipment.

1. Press and hold [–SETUP, OFF] for about 2 seconds.

The setting items are displayed. (→ page 21)

2. Press [◀][▶] to select “**RESET**” and press [OK].

3. Press [▲][▼] to select “**YES**” and press [OK].

YES : Choice for resetting **NO** : Choice against resetting

- To cancel, select “**NO**”.

○ ○ ○ Note ○ ○ ○

- All the settings are reset when you select “**YES**” and the Input Selector automatically switches to “**BD/DVD**”.
- If you select “**NO**”, you will return to step 2. To exit setup mode, press [↵ RETURN] a few times to display “**EXIT**”, and then press [OK].
- The contents of the speaker setting are not reset. However, the contents set at “Changing the number of speakers to 4” (→ page 15) are reset.

When other equipment (mini component system, AV amp, etc.) manufactured by Panasonic operates with the remote control operations of this system

When using this system’s remote control, other equipment may operate. In this case, switch this system’s remote control code to “**REMOTE 1**”. Do the following to set the same code number for this main unit and remote control.

Setting the main unit

1. Press and hold [–SETUP, OFF] for about 2 seconds.

The setting items are displayed. (→ page 21)

2. Press [◀][▶] to select “**REMOTE**” and press [OK].

3. Press [▲][▼] to select “**1**” and press [OK].

Factory setting: **2**

- You cannot finish the setting mode until the setting on the remote control is changed. Go to step 4.
- To set the remote control code to 2, select “**2**” in step 3 and press [OK].

Setting the remote control

4. Press and hold [OK], and then press [TV] (more than 2 seconds).

TV: Remote control code 1

BD/DVD: Remote control code 2 (factory setting)

- Select the same number as the code number you have selected in step 3.
- To set the remote control code to 2, press and hold [OK] in step 4, and then press [BD/DVD] more than 2 seconds.

5. Press [↵ RETURN] several times to select “**EXIT**” and press [OK] to finish the setting.

○ ○ ○ Note ○ ○ ○

If different codes are set between the main unit and remote control, the error message “**REMOTE 2**” or “**REMOTE 1**” is displayed.

Troubleshooting guide

Before requesting service, make the following checks.

If you are in doubt about some of the check points, or if the remedies indicated in the chart do not solve the problem, refer to “Customer Services Directory (United States and Puerto Rico)” on page 30 if you reside in the U.S.A. or Puerto Rico, or refer to “Product information” on page 29 if you reside in Canada.

	Problem	Possible solution	Pages
Common problems	No power.	<ul style="list-style-type: none"> Ensure the AC power supply cord is connected. 	12
	“2CH SEARCH” or “4CH SEARCH” does not go off on the display while setting the speakers.	<ul style="list-style-type: none"> Make sure that the speakers are on. ⇒ If the display does not go off even when the speakers are on, consult your dealer. 	13,15
	No sound or image after playback starts.	<ul style="list-style-type: none"> Select the correct source. Turn the muting off. Check that the digital signals can be decoded by this system. With the optical fiber connection, cannot play back PCM signal with sampling frequency of over 96 kHz. Check connections to other equipment. (When the audio is not heard from TV) The optical fiber cable or stereo connection cable is necessary to connect with a TV incompatible with ARC. For details, refer to the operating instructions for the connected TV. Set “AUTO” in “Switching the input signal detection setting”. Turn this system off then on again. Make sure that the speakers are on. Make sure that the speakers have been properly set. Adjust the speakers. If the connections are normal, this may be a cable-related problem. Use other cables and make connections again. 	16 20 27
			9 to 12 9
			24 —
			13,15 14 20,21 —
	The remote control does not work.	<ul style="list-style-type: none"> Replace the batteries if they are worn. Make sure the remote control code has been properly set. 	7 24
	No sound from microphone connected to DVD player (karaoke).	<ul style="list-style-type: none"> No sound is output from microphone if this system is digitally connected with DVD player. Change to analog connection and input. Make analog connection to AUX3. 	11,12
	There is no DTS audio output. There is audio output, but the DTS decoder indicator is not lit.	<ul style="list-style-type: none"> Set the DTS Digital Audio Output setting on the DVD player, Blu-ray Disc player or DVD recorder to Bitstream. Set “DTS” in “Switching the input signal detection setting”. 	— 24
	Sound is not heard when playing DVD audio.	<ul style="list-style-type: none"> This may occur due to digital copyright protection of the disc if using optical digital connection. This system may not be able to play sources with sampling frequency of over 48 kHz. 	—
“F70 □□□□” appears on the display. (“DSP” or “HDMI” is displayed in □.)	<ul style="list-style-type: none"> Turn off the system, unplug the AC power supply cord, and consult your dealer. 	—	
“F76” appears on the display. (After displayed, the system turns off.)	<ul style="list-style-type: none"> Unplug the AC power supply cord, and consult your dealer. 	—	
This system switches to standby mode.	<ul style="list-style-type: none"> This system is automatically turned off when no signal is input and no operation is performed for approx. 30 minutes. 	—	
Sound field	No sound in surround mode	<ul style="list-style-type: none"> Set to Dolby Virtual Speaker, Dolby Pro Logic II or SFC. 	17
	Cannot use Dolby Virtual Speaker, Dolby Pro Logic II or SFC.	<ul style="list-style-type: none"> You cannot use these features with PCM signals with sampling frequency of over 48 kHz. Make analog connection to AUX3. You cannot use for Dolby Digital dual sounds. 	11,12 —
HDMI	When using an HDMI connection, the first few seconds of sound is cut off.	<ul style="list-style-type: none"> This may occur if you start play from a chapter on a DVD. The following will correct the problem. ① Change the audio output setting on the Blu-ray Disc player, DVD recorder or DVD player from Bitstream to PCM. ② Change input signal setting to “PCM” in “Switching the input signal detection setting”. 	— 24
	The system does not work properly.	<ul style="list-style-type: none"> The system does not work properly if you have connected the HDMI input and output terminals incorrectly. Turn the system off, unplug the AC power supply cord, and make the connection again. 	9
	Could watch TV (VIERA) when installed, but now cannot watch TV.	<ul style="list-style-type: none"> When using this system in combination with the TV (VIERA) only, check if HDMI cable is not connected to “BD/DVD IN” of this system. If it is connected to “BD/DVD IN”, connect to “TO TV (ARC) OUT”. 	—
	The sounds of the first few seconds are cut off when playing back 7.1-channel LPCM signals.	<ul style="list-style-type: none"> This may occur when playing back 7.1-channel LPCM signals of a Blu-ray disc. Press [◀◀ SKIP] on the remote control of recorder or player to play back again from the beginning. 	—

Problem		Possible solution	Pages
HDMI	VIERA Link "HDAVI Control" does not function properly.	<ul style="list-style-type: none"> Confirm "VIERA Link "HDAVI Control" setting" is set to "ON" (when the operation is linked). When it is "OFF", change to "ON". 	23
		<ul style="list-style-type: none"> VIERA Link "HDAVI Control" does not function in Standby condition (HDMI off mode) when this system is turned off. See "Reducing Standby power consumption (In Standby condition (HDMI off mode))" and set to "ON" (normal power consumption). Check VIERA Link "HDAVI Control" settings of the connected equipment. VIERA Link "HDAVI Control" may not function when you change the connections for HDMI equipment, insert and remove the outlet, or during blackout. Do the following operations in this case: <ul style="list-style-type: none"> Turn on the TV (VIERA) again while all the equipment connected with HDMI cables is on. Set "VIERA Link "HDAVI Control" (HDMI equipment control)" of the TV (VIERA) to "OFF" and then set to "ON" again. (For details, refer to the operating instructions for the TV (VIERA).) Connect this system to the TV (VIERA) using the HDMI cable, switch the TV (VIERA) on, unplug this system's AC power supply cord, and insert it into a household AC outlet again. 	22 — —
		<ul style="list-style-type: none"> When using VIERA Link "HDAVI Control" and the speaker is set to "TV", press the VIERA Link button on the remote control of the TV (VIERA) and set the speaker to "Home Cinema". 	18
	This system's input automatically switches to "AUX2 / STB", but sound is not heard. Or unexpected sound from other equipment is heard.	<ul style="list-style-type: none"> After "Setting for automatically switching the input source to STB", the connection might have been changed. Select OFF once and SET again. 	10
Speakers	[WIRELESS LINK] indicator on the speakers does not light green. Sounds are interrupted.	<ul style="list-style-type: none"> When the [WIRELESS LINK] indicator is off, check the connection of the AC power supply cord of the speakers and check that each speaker is "ON". If the [WIRELESS LINK] indicator does not change from red to green, the main unit and speakers are not linked. Make sure that the main unit is "ON". Or make the speaker settings again. You may be using wireless headphones or the wireless LAN may be operating near this system. These symptoms may be remedied by slightly moving this system's position. 	12,13,15 13,15 —
	Sound stops. (The indicator blinks red and green alternately.) The protection circuit is activated when some abnormality is detected, and turns off the system automatically.	<ul style="list-style-type: none"> Amplifier output is abnormal. Straining of the speakers through excessive volume or power. This may occur if you use the system in an extremely hot environment. <ul style="list-style-type: none"> ⇒ Determine and correct the cause, then turn the system on. (The protection circuit is reset.) (Consult your dealer if the problem persists.) 	— — —

Digital signals that can be played on this system

- **Dolby Digital**
Blu-ray disc, DVD etc.
- **DTS**
Blu-ray disc, DVD etc.
- **PCM (2-channel)**
CD, DVD audio etc.
- **Multi-channel LPCM (Linear PCM)**
Blu-ray disc, DVD audio etc.
- **This system supports 3D, X.V. Color or Deep Color.**



- With HDMI connection, this system can play back multi-channel LPCM signals with sampling frequencies of over 48 kHz and PCM signals of over 96 kHz in addition to multi-channel LPCM of up to 48 kHz and PCM of up to 96 kHz. (If frequency exceeds these figures, playback equipment performs down-sampling and plays back as 48 kHz signals. However, playback may be impossible depending on the discs. See operating instructions of playback equipment for more information.)
- With the optical fiber connection, this system can play multi-channel LPCM signals with sampling frequencies of up to 48 kHz and PCM signals of up to 96 kHz.
- See "Glossary" (→ page 28) for more detailed information on each signal.

Maintenance

Unplug the AC power supply cord from the household AC outlet and wipe the system using a soft and dry cloth.

- When the system is very dirty, wring the cloth soaked in water thoroughly, wipe the dirt and wipe moisture off with a dry cloth.
- Do not use solvents such as benzine, thinner, alcohol, etc. because they may cause casing to deform and coating to come off.
- Before using chemically treated cloth, read the instructions that come with the cloth carefully.

Glossary

ARC (Audio Return Channel)

This function was added to HDMI Ver.1.4. This sends digital audio signals from the HDMI input terminal of the TV, etc. to the HDMI output terminal of this system.

CPPM (Content Protection for Prerecorded Media)

This is the copyright protection technology which prevents file copy of DVD audio.

Decoder, Decode

Decoder is the device to enable us to hear audio data that is encoded on DVD, etc., as a normal audio signal. This process is called Decode.

Deep Color

This system can reproduce greater color gradation (4096 steps) when connected to a compatible TV and recorder, etc. You can enjoy exceptionally rich, natural-looking colors, with smooth, detailed gradation and minimal color banding.

Dolby Digital

Digital sound compression technology developed by Dolby Laboratories. Compatible with surround sound as well as 2-channel stereo sound. With this technology, you can keep massive amount of audio data in a disc efficiently.

Dolby Pro Logic II

This system can process not only Dolby Surround, but also other 2-channel sources to produce a 5.1-channel sound for a more realistic sound field. It is also possible to enhance old movies recorded in stereo with this dynamic 5.1-channel sound. This system uses Dolby Pro Logic II to add surround effects to stereo sources such as video cassettes and CDs.

Dolby Virtual Speaker

This system allows you to enjoy a surround effect with two front speakers. This is not merely a "virtual surround" effect, but rather uses the optimal speaker arrangements and listening positions for 5.1-channel sound.

Down-sampling

This is the process of resampling by reducing the sampling rate of a signal that was sampled at a certain rate.

DTS (Digital Theater Systems)

Surround system used in most movie theaters. Separation works well between channels, resulting in realistic surround effects.

Dynamic range

Dynamic range is the difference between the lowest level of sound that can be heard above the noise of the equipment and the highest level of sound before distortion occurs.

HDMI (High Definition Multimedia Interface)

HDMI enables you to transmit digital audio and video signals using a single cable. You can also transmit control signals using HDMI connections.

Multi-channel LPCM (Linear PCM)

This is the uncompressed audio signal encoded digitally. Multi-channel LPCM signals used for Blu-ray Disc, DVD audio, etc. offer playback with higher-sound quality. Up to 7.1-channel LPCM signals can be input to this system.

Optical

Using an optical fiber cable for digital signal input/output from DVD, CD, etc., provides better sound quality for playback or recording compared to analog. Only possible with equipment that has an optical terminal.

PCM (Pulse Code Modulation)

This is one of the methods that enable analog sounds to be converted to digital sounds without compression. This method is used for music CD, etc.

Sampling frequency

Sampling is the process of converting the heights of sound wave (analog signal) samples taken at set periods into digits (digital encoding). Sampling frequency is the number of samples taken per second, so larger numbers mean faithful reproduction of the original sound.

Standby through function

When this system and the TV and Blu-ray Disc player/DVD recorder etc. are connected with HDMI cables, image/audio from Blu-ray Disc player/DVD recorder etc. can still be transmitted to the TV through this system even though the system is turned off. This is useful when you want to enjoy late night viewing only with the television speakers. Images recorded with x.v.Color or Deep Color are also supported.

Surround signal

Audio signal made up with front speakers, center speaker and surround speakers. For this system, surround signal is automatically played by Dolby Virtual Speaker.

WHISPER-MODE SURROUND

Even when the sound volume level is low, you can enjoy dynamic surround playback similarly as during normal playback. This is convenient when listening at night.

x.v.Color

This is a name of products compliant with ISO Standard for wider color space: "xvYCC". This system supports x.v.Color.

1080p

This is one of the digital hi-vision images. 1080 is the number of effective scanning lines that constitute the actual screen. This enables every detail to be beautifully expressed. Images are less flickered with progressive method that scans in order from the top. This system supports 1080p.

5.1-channel surround

Monaural and stereo use one channel and two channels respectively to reproduce sound, but 5.1-channel surround uses 5 speakers and 1 subwoofer. The 5 channels are: 1 center speaker, 2 front speakers, and 2 surround speakers at the side of or to the rear of the sitting position. Sound output of the subwoofer is much narrower than the other speakers, and so is considered as 0.1. This is called 5.1-channel surround when played through all 5.1 channels, and with this system you can achieve a similar effect with Dolby Virtual Speaker.

7.1-channel virtual surround

When playing back 7.1-channel LPCM signals with this function, you can enjoy wider sound field effects as if another speaker is added.

Product Service

- 1. Damage requiring service** — The unit should be serviced by qualified service personnel if:
 - (a) The AC power supply cord or the plug has been damaged; or
 - (b) Objects or liquids have gotten into the unit; or
 - (c) The unit has been exposed to rain; or
 - (d) The unit does not operate normally or exhibits a marked change in performance; or
 - (e) The unit has been dropped or the cabinet damaged.
- 2. Servicing** — Do not attempt to service the unit beyond that described in these operating instructions. Refer all other servicing to authorized servicing personnel.
- 3. Replacement parts** — When parts need replacing ensure the servicer uses parts specified by the manufacturer or parts that have the same characteristics as the original parts. Unauthorized substitutes may result in fire, electric shock, or other hazards.
- 4. Safety check** — After repairs or service, ask the servicer to perform safety checks to confirm that the unit is in proper working condition.

The servicer will require all components to service your system. Therefore, should service ever be necessary, be sure to bring the entire system.

Product information

For product information or assistance with product operation:

In the U.S.A. and Puerto Rico, refer to "Customer Services Directory (United States and Puerto Rico)" on page 30.

In Canada, contact the Panasonic Canada Inc. Customer Care Centre at 1-800-561-5505, or visit the website (www.panasonic.ca), or an authorized Servicentre closest to you.

Listening caution



Selecting fine audio equipment such as the unit you've just purchased is only the start of your musical enjoyment. Now it's time to consider how you can maximize the fun and excitement your equipment offers. This manufacturer and the Electronic Industries Association's Consumer Electronics Group want you to get the most out of your equipment by playing it at a safe level. One that lets the sound come through loud and clear without annoying blaring or distortion-and, most importantly, without affecting your sensitive hearing.

We recommend that you avoid prolonged exposure to excessive noise.

Sound can be deceiving. Over time your hearing "comfort level" adapts to higher volumes of sound. So what sounds "normal" can actually be loud and harmful to your hearing.

Guard against this by setting your equipment at a safe level BEFORE your hearing adapts.

To establish a safe level:

- Start your volume control at a low setting.
- Slowly increase the sound until you can hear it comfortably and clearly, and without distortion.

Once you have established a comfortable sound level:

- Set the dial and leave it there.

Taking a minute to do this now will help to prevent hearing damage or loss in the future. After all, we want you listening for a lifetime.

The model number and serial number of this product can be found on either the back or the bottom of the unit.

Please note them in the space provided below and keep for future reference.

MODEL NUMBER SC-ZT2

SERIAL NUMBER _____

User memo:

DATE OF PURCHASE _____

DEALER NAME _____

DEALER ADDRESS _____

TELEPHONE NUMBER _____

HDMI, the HDMI Logo, and High-Definition Multimedia Interface are trademarks or registered trademarks of HDMI Licensing LLC in the United and other countries.

HDAVI Control™ is a trademark of Panasonic Corporation.

EZ Sync™ is a trademark of Panasonic Corporation.

VIERA Link™ is a trademark of Panasonic Corporation.

Manufactured under license from Dolby Laboratories. Dolby, Pro Logic, and the double-D symbol are trademarks of Dolby Laboratories.

Manufactured under license under U.S. Patent #'s: 5,451,942; 5,956,674; 5,974,380; 5,978,762; 6,487,535 & other U.S. and worldwide patents issued & pending. DTS and the Symbol are registered trademarks & DTS Digital Surround and the DTS logos are trademarks of DTS, Inc. Product includes software. © DTS, Inc. All Rights Reserved.

-If you see this symbol-

Information on Disposal in other Countries outside the European Union



This symbol is only valid in the European Union. If you wish to discard this product, please contact your local authorities or dealer and ask for the correct method of disposal.

Limited Warranty (ONLY FOR U.S.A. AND PUERTO RICO)

Panasonic Consumer Electronics Company,
Division of Panasonic Corporation of North America
One Panasonic Way, Secaucus, New Jersey 07094

Panasonic Home Audio Products Limited Warranty

Limited Warranty Coverage (For USA and Puerto Rico Only)

If your product does not work properly because of a defect in materials or workmanship, Panasonic Consumer Electronics Company (referred to as "the warrantor") will, for the length of the period indicated on the chart below, which starts with the date of original purchase ("warranty period"), at its option either (a) repair your product with new or refurbished parts, (b) replace it with a new or a refurbished equivalent value product, or (c) refund your purchase price. The decision to repair, replace or refund will be made by the warrantor.

Product or Part Name	Parts	Labor
Audio Products (except items below)	1 year	1 year
DVD Home Theater System	1 year	1 year
USB Reader-writer, PC Card Adapters (defective exchange)	1 year	Not Applicable
Accessories: Headphones, cartridges, Microphones, Adapters	90 days	90 days
Rechargeable Batteries, DVD-RAM Disc (defective exchange)	10 days	Not Applicable
SD Memory Cards, Rechargeable Battery Packs (defective exchange)	90 days	Not Applicable

During the "Labor" warranty period there will be no charge for labor. During the "Parts" warranty period, there will be no charge for parts. This Limited Warranty excludes both parts and labor for non-rechargeable batteries, antennas, and cosmetic parts (cabinet). This warranty only applies to products purchased and serviced in the United States or Puerto Rico. This warranty is extended only to the original purchaser of a new product which was not sold "as is".

Carry-In or Mail-In Service

To find a service center please visit <http://www.panasonic.com/help> or call 1-800-211-PANA (7262).

When shipping the unit, carefully pack, include all accessories, and send it prepaid, adequately insured and preferably in the original carton. If Lithium Ion batteries are shipped by air the package must be labeled "Contains Lithium Ion Battery (No lithium metal)". Damaged batteries are prohibited from shipment by US Mail. Batteries must be securely packed in a manner to prevent short-circuiting and a package cannot contain more than 3 Lithium Ion batteries. Include a letter detailing the complaint, a return address and provide a daytime phone number where you can be reached. A valid registered receipt is required under the Limited Warranty.

IF REPAIR IS NEEDED DURING THE WARRANTY PERIOD, THE PURCHASER WILL BE REQUIRED TO FURNISH A SALES RECEIPT/PROOF OF PURCHASE INDICATING DATE OF PURCHASE, AMOUNT PAID AND PLACE OF PURCHASE. CUSTOMER WILL BE CHARGED FOR THE REPAIR OF ANY UNIT RECEIVED WITHOUT SUCH PROOF OF PURCHASE.

Limited Warranty Limits And Exclusions

This warranty ONLY COVERS failures due to defects in materials or workmanship, and DOES NOT COVER normal wear and tear or cosmetic damage. The warranty ALSO DOES NOT COVER damages which occurred in shipment, or failures which are caused by products not supplied by the warrantor, or failures which result from accidents, misuse, abuse, neglect, mishandling, misapplication, alteration, faulty installation, set-up adjustments, misadjustment of consumer controls, improper maintenance, power line surge, lightning damage, modification, introduction of sand, humidity or liquids,

commercial use such as hotel, office, restaurant, or other business or rental use of the product, or service by anyone other than a Factory Service Center or other Authorized Servicer, or damage that is attributable to acts of God.

THERE ARE NO EXPRESS WARRANTIES EXCEPT AS LISTED UNDER "LIMITED WARRANTY COVERAGE".

THE WARRANTOR IS NOT LIABLE FOR INCIDENTAL OR CONSEQUENTIAL DAMAGES RESULTING FROM THE USE OF THIS PRODUCT, OR ARISING OUT OF ANY BREACH OF THIS WARRANTY.

(As examples, this excludes damages for lost time, travel to and from the servicer, loss of or damage to media or images, data or other memory or recorded content. The items listed are not exclusive, but for illustration only.)

ALL EXPRESS AND IMPLIED WARRANTIES, INCLUDING THE WARRANTY OF MERCHANTABILITY, ARE LIMITED TO THE PERIOD OF THE LIMITED WARRANTY.

Some states do not allow the exclusion or limitation of incidental or consequential damages, or limitations on how long an implied warranty lasts, so the exclusions may not apply to you.

This warranty gives you specific legal rights and you may also have other rights which vary from state to state. If a problem with this product develops during or after the warranty period, you may contact your dealer or Service Center. If the problem is not handled to your satisfaction, then write to the warrantor's Consumer Affairs Department at the addresses listed for the warrantor.

PARTS AND SERVICE, WHICH ARE NOT COVERED BY THIS LIMITED WARRANTY, ARE YOUR RESPONSIBILITY.

Customer Services Directory (United States and Puerto Rico)

Obtain Product Information and Operating Assistance; locate your nearest Dealer or Service Center; purchase Parts and Accessories; or make Customer Service and Literature requests by visiting our Web Site at:

<http://www.panasonic.com/help>

or, contact us via the web at:

<http://www.panasonic.com/contactinfo>

You may also contact us directly at:

1-800-211-PANA (7262)

Monday-Friday 9am-9pm, Saturday-Sunday 10am-7pm EST

For hearing or speech impaired TTY users, TTY: 1-877-833-8855

Accessory Purchases (United States and Puerto Rico)

Purchase Parts, Accessories and Instruction Books online for all Panasonic Products by visiting our Web Site at:

<http://www.pstc.panasonic.com>

Or, send your request by E-mail to:

npcparts@us.panasonic.com

You may also contact us directly at:

1-800-332-5368 (Phone) 1-800-237-9080 (Fax Only)

(Monday-Friday 9am-9pm EST)

Panasonic Service and Technology Company

20421 84th Avenue South, Kent, WA 98032

(We accept Visa, MasterCard, Discover Card, American Express, and Personal Checks)

For hearing or speech impaired TTY users, TTY: 1-866-605-1277

As of November 2009

Limited Warranty (ONLY FOR CANADA)

Panasonic Canada Inc.

PANASONIC PRODUCT – LIMITED WARRANTY

Panasonic Canada Inc. warrants this product to be free from defects in material and workmanship and agrees to remedy any such defect for a period as stated below from the date of original purchase.

Technics Audio Product	One (1) year, parts and labour
Panasonic Portable / Clock Radio (without Tape, CD, MD)	One (1) year, parts and labour
Panasonic Audio / SD Audio Product	One (1) year, parts and labour
Panasonic DVD Product	One (1) year, parts and labour
Panasonic Combination DVD Player / VCR	One (1) year, parts and labour
Panasonic Combination DVD Recorder / VCR	One (1) year, parts and labour
Accessories including rechargeable batteries	Ninety (90) days

LIMITATIONS AND EXCLUSIONS

This warranty does not apply to products purchased outside Canada or to any product which has been improperly installed, subjected to usage for which the product was not designed, misused or abused, damaged during shipping, or which has been altered or repaired in any way that affects the reliability or detracts from the performance, nor does it cover any product which is used commercially. Dry cell batteries are also excluded from coverage under this warranty.

This warranty is extended to the original end user purchaser only. A purchase receipt or other proof of date of original purchase is required before warranty service is performed.

THIS EXPRESS, LIMITED WARRANTY IS IN LIEU OF ALL OTHER WARRANTIES, EXPRESS OR IMPLIED, INCLUDING ANY IMPLIED WARRANTIES OF MERCHANTABILITY AND FITNESS FOR A PARTICULAR PURPOSE. IN NO EVENT WILL PANASONIC CANADA INC. BE LIABLE FOR ANY SPECIAL, INDIRECT OR CONSEQUENTIAL DAMAGES.

In certain instances, some jurisdictions do not allow the exclusion or limitation of incidental or consequential damages, or the exclusion of implied warranties, so the above limitations and exclusions may not be applicable.

WARRANTY SERVICE

FOR PRODUCT OPERATION ASSISTANCE, please contact:

Our Customer Care Centre:	Telephone #:	(905) 624-5505
	1-800 #:	1-800-561-5505
	Fax #:	(905) 238-2360
	Email link:	"Customer support" on www.panasonic.ca

FOR PRODUCT REPAIRS, please locate your nearest Authorized Servicentre at www.panasonic.ca :

Link : "ServicentresTM locator" under "Customer support"

IF YOU SHIP THE PRODUCT TO A SERVICENTRE

Carefully pack and send prepaid, adequately insured and preferably in the original carton.
Include details of the defect claimed, and proof of date of original purchase.

Safety precautions

- Do not use this device in hospitals and other places where electric medical devices are installed.
- Do not use this device near automatic doors, fire alarms and other automatically controlled apparatus.
- Do not hold the speaker with one hand.
- Before attaching the leg cushion on the base parts of speakers to prevent tilt or rattle on the floor, make sure there are no people in the surrounding area.
- Do not insert your hand or foot into the opening of side surface of base part.
- Do not turn on the speakers with foot or vacuum cleaner carelessly.
- Do not use this device as a plaything.

THE FOLLOWING APPLIES ONLY IN THE U.S.A.

FCC Note:

This equipment has been tested and found to comply with the limits for a Class B digital device, pursuant to Part 15 of the FCC Rules. These limits are designed to provide reasonable protection against harmful interference in a residential installation. This equipment generates, uses and can radiate radio frequency energy and, if not installed and used in accordance with the instructions, may cause harmful interference to radio communications.

However, there is no guarantee that interference will not occur in a particular installation. If this equipment does cause harmful interference to radio or television reception, which can be determined by turning the equipment off and on, the user is encouraged to try to correct the interference by one or more of the following measures:

- Reorient or relocate the receiving antenna.
- Increase the separation between the equipment and receiver.
- Connect the equipment into an outlet on a circuit different from that to which the receiver is connected.
- Consult the dealer or an experienced radio/TV technician for help.

FCC caution: To maintain compliance with FCC regulations, shielded interface cables must be used with this equipment. Operation with non-approved equipment or unshielded cables may result in interference to radio and TV reception. Any changes or modifications not approved by the party responsible for compliance could void the user's authority to operate this equipment.

This device complies with Part 15 of the FCC Rules.

Operation is subject to the following two conditions:

- (1) This device may not cause harmful interference, and
- (2) this device must accept any interference received, including interference that may cause undesired operation.

This transmitter must not be co-located or operated in conjunction with any other antenna or transmitter.

This equipment complies with FCC radiation exposure limits set forth for uncontrolled equipment and meets the FCC radio frequency (RF) Exposure Guidelines in Supplement C to OET65. This equipment has very low levels of RF energy that it deemed to comply without maximum permissive exposure evaluation (MPE). But it is desirable that it should be installed and operated with at least 20 cm and more between the radiator and person's body (excluding extremities: hands, wrists, feet and ankles).

Responsible Party:

Panasonic Corporation of North America
One Panasonic Way
Secaucus, NJ 07094

Support Contact:

Panasonic Consumer Electronics Company
Telephone No.: 1-800-211-PANA (7262)

THE FOLLOWING APPLIES ONLY IN CANADA.

This device complies with RSS-210 of the IC Rules.

Operation is subject to the following two conditions:

- (1) This device may not cause harmful interference,
- (2) This device must accept any interference received, including interference that may cause undesired operation of the device.

This equipment complies with IC radiation exposure limits set forth for uncontrolled equipment and meets RSS-102 of the IC radio frequency (RF) Exposure rules. This equipment has very low levels of RF energy that it deemed to comply without maximum permissive exposure evaluation (MPE). But it is desirable that it should be installed and operated with at least 20 cm and more between the radiator and person's body (excluding extremities: hands, wrists, feet and ankles).

THE FOLLOWING APPLIES ONLY IN CANADA.

This Class B digital apparatus complies with Canadian ICES-003.

Panasonic Consumer Electronics
Company, Division of Panasonic
Corporation of North America
One Panasonic Way, Secaucus,
New Jersey 07094
<http://www.panasonic.com>

Panasonic Canada Inc.
5770 Ambler Drive
Mississauga, Ontario
L4W 2T3
www.panasonic.ca