

Panasonic[®]

DT50K series
DT50M series
DT50T series
DT50X series

ET50K series
ET50M series
ET50T series

Operating Instructions LED TV



VIERA



Thank you for purchasing this Panasonic product.
Please read these instructions carefully before operating this product and
retain them for future reference.
The images shown in this manual are for illustrative purposes only.



English







CBJ

TQB4GC0894-1

 <p>SDXC Logo is a trademark of SD-3C, LLC.</p>	  <p>“Full HD 3D Glasses™” logo and “Full HD 3D Glasses™” word are trademark of Full HD 3D Glasses Initiative</p>
--	--

 <p>DLNA®, the DLNA Logo and DLNA CERTIFIED™ are trademarks, service marks, or certification marks of the Digital Living Network Alliance.</p>	 <p>“AVCHD”, “AVCHD 3D” and “AVCHD Progressive” are trademarks of Panasonic Corporation and Sony Corporation.</p>
---	--

 <p>Manufactured under license from Dolby Laboratories. Dolby and the double-D symbol are trademarks of Dolby Laboratories.</p>	 <p>QuickTime and the QuickTime logo are trademarks or registered trademarks of Apple Inc., used under license therefrom.</p>
--	--

 <p>Manufactured under license under U.S. Patent Nos: 5,956,674; 5,974,380; 6,487,535 & other U.S. and worldwide patents issued & pending. DTS, the Symbol, & DTS and the Symbol together are registered trademarks & DTS 2.0+Digital Out is a trademark of DTS, Inc. Product includes software. © DTS, Inc. All Rights Reserved.</p>	 <p>DivX®, DivX Certified®, DivX Plus® HD and associated logos are trademarks of Rovi Corporation or its subsidiaries and are used under license.</p>  <p>“RealD 3D” is a trademark of RealD.</p>
--	---

The Bluetooth® word mark and logos are registered trademarks owned by the Bluetooth SIG, Inc. and any use of such marks by Panasonic Corporation is under license. Other trademarks and trade names are those of their respective owners.

HDMI, the HDMI Logo, and High-Definition Multimedia Interface are trademarks or registered trademarks of HDMI Licensing LLC in the United States and other countries.

Windows is a registered trademark of Microsoft Corporation in the United States and other countries.

VGA is a trademark of International Business Machines Corporation.

S-VGA is a registered trademark of the Video Electronics Standard Association.

➔ See page 95 for more information.

Transport only in upright position

Panasonic does not guarantee operation and performance of peripheral devices made by other manufacturers; and we disclaim any liability or damage arising from operation and/or performance from usage of such other maker's peripheral devices.

This product is licensed under the AVC patent portfolio license for the personal and non-commercial use of a consumer to (i) encode video in compliance with the AVC Standard ("AVC Video") and/or (ii) decode AVC Video that was encoded by a consumer engaged in a personal and non-commercial activity and/or was obtained from a video provider licensed to provide AVC Video. No license is granted or shall be implied for any other use. Additional information may be obtained from MPEG LA, LLC. See <http://www.mpegla.com>.

"Full HD 3D Glasses™" Logo indicates compatibility between TV products and 3D Eyewear which are compliant with the "Full HD 3D Glasses™" format, and does not indicate picture quality of TV products.

The illustration for DT50K series is used in this manual unless otherwise mentioned. Illustrations shown may be different between models and countries.

Contents

Be Sure to Read

Safety Precautions	4
--------------------------	---

Quick Start Guide

Accessories / Options	6
Identifying Controls	10
Basic Connection	12
Auto Tuning	15

Enjoy your TV!

Basic

Using "VIERA Connect"	18
Watching TV	19
Viewing Teletext	23
Watching External Inputs	25
Viewing 3D images	27
How to Use VIERA TOOLS	35
How to Use Menu Functions	36

Advanced

Tuning and Editing Channels	43
Child Lock	46
Shipping Condition	47
Displaying PC Screen on TV	48
Advanced Picture Settings	49
Using Media Player	51
Using Network Services (DLNA / VIERA Connect)	60
Link Functions (VIERA Link)	70
External Equipment	77

Others

Technical Information	80
FAQs	89
Maintenance	91
Specifications	92
Licence	95

Safety Precautions

Warning

Safety Precautions

Handling the mains plug and lead

- Insert the mains plug fully into the socket outlet. (If the mains plug is loose, it could generate heat and cause fire.)
- Ensure that the mains plug is easily accessible.
- Do not touch the mains plug with a wet hand. (This may cause electrical shock.)
- Do not use any mains lead other than that provided with this TV. (This may cause fire or electrical shock.)
- Do not damage the mains lead. (A damaged lead may cause fire or electrical shock.)
 - Do not move the TV with the lead plugged in the socket outlet.
 - Do not place a heavy object on the lead or place the lead near a high-temperature object.
 - Do not twist the lead, bend it excessively or stretch it.
 - Do not pull on the lead. Hold onto the mains plug body when disconnecting the lead.
- Do not use a damaged mains plug or socket outlet.

If you find any abnormality, remove the mains plug immediately!

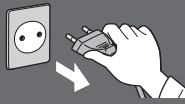

AC 110-240 V
50 / 60 Hz



- Mains plug types vary between countries.

Power source

- This TV is designed to operate on:
 - AC 110-240 V, 50 / 60 Hz
 - Table-top use

Do not remove covers and NEVER modify the TV yourself

- Do not remove the rear cover as live parts are accessible when it is removed. There are no user serviceable parts inside. (High-voltage components may cause serious electrical shock.)
- Have the TV checked, adjusted, or repaired at your local Panasonic dealer.

Do not expose to direct sunlight and other sources of heat

- Avoid exposing the TV to direct sunlight and other sources of heat.



To prevent the spread of fire, keep candles or other open flames away from this product at all times

Do not expose to rain or excessive moisture

- To prevent damage which might result in electric shock or fire, do not expose this TV to rain or excessive moisture. This TV must not be exposed to dripping or splashing water and objects filled with liquid, such as vases, must not be placed on top of or above the TV.

Do not insert foreign objects into the TV

- Do not allow any objects to drop into the TV through the air vents. (Fire or electrical shock may result.)

Do not place the TV on sloped or unstable surfaces, and ensure that the TV does not hang over the edge of the base

- The TV may fall off or tip over.

Use only the dedicated pedestals / mounting equipment

- Using an unapproved pedestal or other fixtures may make the TV unstable, risking injury. Be sure to ask your local Panasonic dealer to perform setup.
- Use approved pedestals (p. 7) / wall-hanging brackets (p. 6).

Do not allow children to handle SD Card or dangerous parts

- As with any small object, the SD Card could be swallowed by young children. Please remove SD Card immediately after use and store out of reach of children.
- This product contains possibly dangerous parts that can be breathed in or swallowed by young children accidentally. Keep these parts out of reach of young children.

Caution

This appliance is intended for use in tropical climates

When cleaning the TV, remove the mains plug

- Cleaning an energised TV may cause electric shock.

Remove the mains plug from the wall socket when the TV is not in use for a prolonged period of time

- This TV will still consume some power even in the Off mode, as long as the mains plug is still connected.

Do not expose your ears to excessive volume from the headphones

- Irreversible damage can be caused.

Do not apply strong force or impact to the display panel

- This may cause damage resulting in injury.

Do not block the rear air vents

- Adequate ventilation is essential to prevent failure of electronic components.
- Ventilation should not be impeded by covering the ventilation openings with items such as newspapers, table cloths and curtains.
- We recommend that a gap of at least 10 cm is left all around this TV even when placed inside a cabinet or between shelves.
- When using the pedestal, keep the space between the bottom of the TV and the surface where the TV is set.
- If pedestal is not used, ensure the vents in the bottom of the TV are not blocked.

Minimum distance

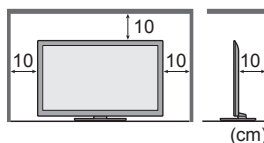

Built-in wireless LAN / Bluetooth

Warning

Radio waves

- Do not use the TV and 3D Eyewear in any medical institutions or locations with medical equipment. Radio waves from the TV and 3D Eyewear may interfere with the medical equipment and cause accidents due to the malfunction.
- Do not use the TV and 3D Eyewear near any automatic control equipment such as automatic doors or fire alarms. Radio waves from the TV and 3D Eyewear may interfere with the automatic control equipment and cause accidents due to the malfunction.
- Keep the distance at least 22 cm from the built-in wireless LAN part and 3D Eyewear when you have a cardiac pacemaker. Radio waves from them may interfere with the operation of the pacemaker.
- Do not disassemble or alter the built-in wireless LAN and 3D Eyewear in any way

Caution

■ Built-in wireless LAN

- To use the built-in wireless LAN, an access point needs to be obtained.
- Do not use the built-in wireless LAN to connect to any wireless network (SSID*) for which you do not have usage rights. Such networks may be listed as a result of searches. However, using them may be regarded as illegal access. *SSID is a name for identifying a particular wireless network for transmission.
- Do not subject the built-in wireless LAN to high temperatures, direct sunlight or moisture.
- Data transmitted and received over radio waves may be intercepted and monitored.
- The built-in wireless LAN uses 2.4 GHz and 5 GHz frequency bands. To avoid malfunctions or slow response caused by radio wave interference, keep the TV away from the devices such as other wireless LAN devices, microwaves, mobile phones and the devices that use 2.4 GHz and 5 GHz signals when using the built-in wireless LAN.
- When noises occur due to the static electricity, etc., the TV might stop operating for the protection of the devices. In this case, turn the TV off with Mains power On / Off switch, then turn it on again.
- Additional information for built-in wireless LAN and access point may be on the following website. (English only)
<http://panasonic.jp/support/global/cs/tv/>

■ Bluetooth® wireless technology

- The TV and 3D Eyewear use the 2.4 GHz radio frequency ISM band (Bluetooth®). To avoid malfunctions or slow response caused by radio wave interference, keep the TV and 3D Eyewear away from the devices such as other wireless LAN devices, other Bluetooth devices, microwaves, mobile phones and the devices that use 2.4 GHz signal.

Accessories / Options

Standard accessories

Remote Control

- N2QAYB000749



3D Eyewear (2)

- (TY-ER3D4MA)
- N5ZZ00000268
- ➔ (p. 28)



Batteries for the Remote Control (2)

- R6 (AA)
- ➔ (p. 7)



Mains lead

- ➔ (p. 12)

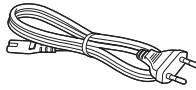

(DT50K series)
(DT50X series)
(ET50K series)

Pedestal

- ➔ (p. 7)

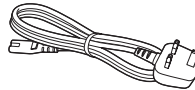
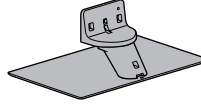

(DT50M series)
(ET50M series)

Clamper

- ➔ (p. 14)

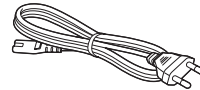

(DT50T series)
(ET50T series)

Terminal adaptors

- AV2 IN (COMPONENT / VIDEO) adaptor
- ➔ (p. 77, 78)

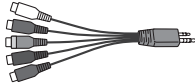

- AV1 IN / AUDIO OUT adaptor
- ➔ (p. 77)

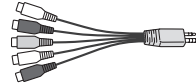

Operating Instructions

- The shape of accessories may differ from the actual.
- Accessories may not be placed all together. Take care not to throw them away unintentionally.
- This product contains possibly dangerous parts (such as plastic bags), that can be breathed in or swallowed by young children accidentally. Keep these parts out of reach of young children.

Optional accessories

Please contact your local Panasonic dealer to purchase the recommended optional accessories. For additional details, please read the manual of the optional accessories.

Wall-hanging bracket

Please contact your local Panasonic dealer to purchase the recommended wall-hanging bracket.

- Holes for wall-hanging bracket installation

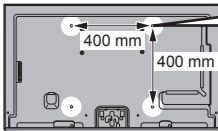

Rear of the TV

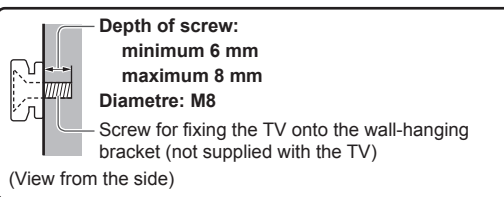

Warning

- Failure to use a Panasonic bracket or choosing to mount the unit yourself will be done at the risk of the consumer. Always be sure to ask a qualified technician to carry out set up. Incorrect fitting may cause equipment to fall, resulting in injury and product damage. Any damage resulting from not having a professional installer mount your unit will void your warranty.
- When any optional accessories or wall hanging brackets are used, always ensure that the instructions provided are followed fully.
- Do not mount the unit directly below ceiling lights (such as spotlights or halogen lights) which typically give off high heat. Doing so may warp or damage plastic cabinet parts.
- Take care when fixing wall brackets to the wall. Wall mounted equipment shall not be grounded by metal within the wall. Always ensure that there are no electrical cables or pipes in the wall before hanging bracket.
- To prevent fall and injury, remove the TV from its fixed wall position when it is no longer in use.

3D Eyewear set

(Rechargeable type)

- TY-ER3D4MW
- TY-ER3D4SW



- If you need 3D Eyewears additionally, please purchase this optional accessory.
- Use Panasonic 3D Eyewear for active 3D supporting Bluetooth wireless technology.
- For more information (English only):
<http://panasonic.net/avc/viera/3d/asia.html>

Communication Camera

- TY-CC20W



- This camera can be used on VIERA Connect (p. 18, 69).
- Depending on the area, this optional accessory may not be available. For details, consult your local Panasonic dealer.

Installing / removing remote's batteries

1

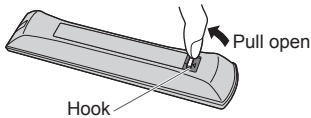

2

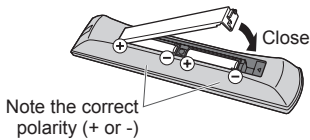

Note the correct polarity (+ or -)

Caution

- Incorrect installation may cause battery leakage and corrosion, resulting in damage to the remote control.
- Do not mix old and new batteries.
- Do not mix different battery types (such as alkaline and manganese batteries).
- Do not use rechargeable (Ni-Cd) batteries.
- Do not burn or break up batteries. Batteries must not be exposed to excessive heat such as sunshine, fire or the like.
- Do not disassemble or modify the remote control.

Attaching / removing the pedestal

Warning

Do not disassemble or modify the pedestal.

- Otherwise the TV may fall over and become damaged, and personal injury may result.

Caution

Do not use any pedestal other than the one provided with this TV.

- Otherwise the TV may fall over and become damaged, and personal injury may result.

Do not use the pedestal if it becomes warped or physically damaged.

- If you use the pedestal while it is physically damaged, personal injury may result. Contact your local Panasonic dealer immediately.

During set-up, make sure that all screws are securely tightened.

- If insufficient care is taken to ensure screws are properly tightened during assembly, the pedestal will not be strong enough to support the TV, and it might fall over and become damaged, and personal injury may result.

Ensure that the TV does not fall over.

- If the TV is knocked or children climb onto the pedestal with the TV installed, the TV may fall over and personal injury may result.

Two or more people are required to install and remove the TV.

- If two or more people are not present, the TV may be dropped, and personal injury may result.

When removing the pedestal from the TV, do not remove the pedestal by the methods other than the specified procedure. → (p. 9)

- Otherwise the TV and / or pedestal may fall over and become damaged, and personal injury may result.

<p>A Assembly screw (4)  M5 × 16</p>	<p>C Assembly screw (2)  M4 × 10 (included with cover)</p>	<p>E Cover • TBL5ZB32301 </p>	<p>F Base • TBL5ZX0256 (42" class) (DT50 series) • TBL5ZX04621 (47" class) (DT50 series) • TBL5ZX0224 (42" class) (ET50 series) • TBL5ZX04661 (47" class) (ET50 series) </p>
<p>B Assembly screw (4)  M4 × 10</p>	<p>D Bracket • TBL5ZA32731 </p>		

■ Preparations

Take out the pedestal and the TV from the packing case and put the TV onto a work table with the screen panel down on the clean and soft cloth (blanket, etc.)

- Use a firm table bigger than the TV.
- Do not hold the screen panel part.
- Make sure not to scratch or break the TV.

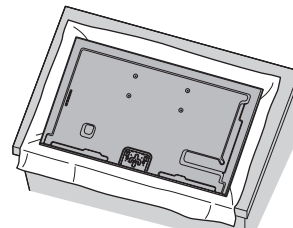

■ Assembling the pedestal

Attach the bracket **D** to the tabs of the top of the base **F** and fix with assembly screws **A**

- Forcing the assembly screws the wrong way will strip the threads.
- Hold the bracket not to fall over.

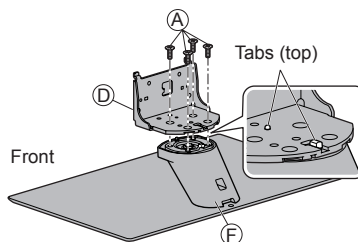

■ Securing the TV

1 Attach the pedestal

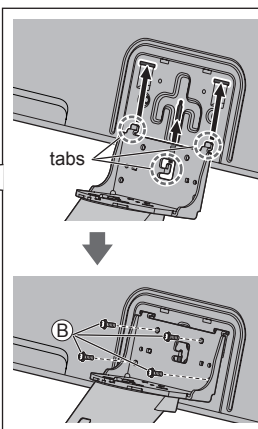
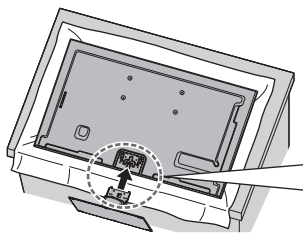

Align the 3 tabs on the bracket with the grooves on the back of the TV and insert them.

Make sure the centre tab is in the hole of the TV. Slide in the bracket aligning the arrow marks (↓↑) on the TV and the bracket.

Tighten the 4 assembly screws **B** loosely at first, then tighten them firmly to fix securely.

2 Attach the cover

Attach the cover **E** and fix securely with assembly screws **C**.

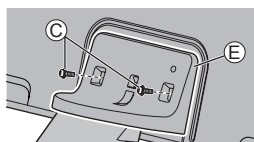

■ Moving the TV

Hold the specified parts as shown to stand the TV up and move it with two people.

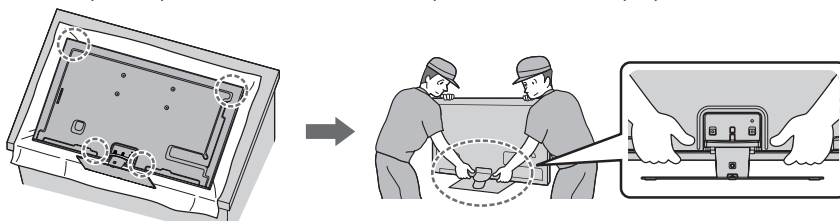

Removing the pedestal from the TV

Be sure to remove the pedestal in the following way when using the wall-hanging bracket or repacking the TV.

- 1 Put the TV onto a work table with the screen panel down on the clean and soft cloth.
- 2 Remove the assembly screws (C) from the cover.
- 3 Remove the assembly screws (B) from the TV.
- 4 Remove the pedestal from the TV.
- 5 Remove the assembly screws (A) from the bracket.

Adjusting the panel to your desired angle

- Do not place any objects within the full rotation range.

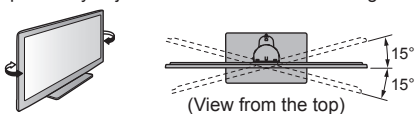

Preventing the TV from falling over

Using the fall-prevent screw hole and a screw (commercially available), securely fix the body of the pedestal to the installation surface.

- The place where the pedestal is to be fixed should be thick enough and made of hard material.

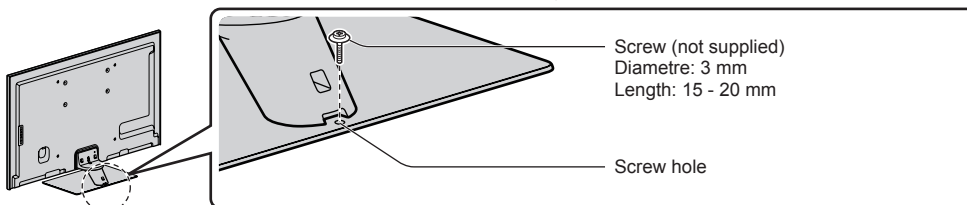

Identifying Controls

Remote Control

Identifying Controls

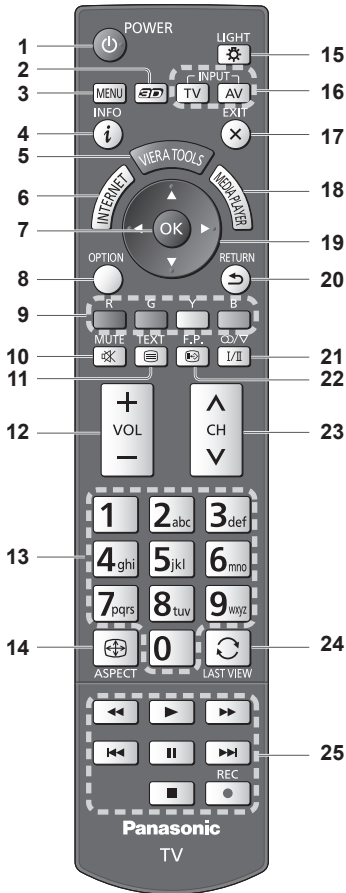

- 1 Standby On / Off switch**
 - Switches TV on or off standby.
- 2 3D button** ➔ (p. 33)
 - Switches the viewing mode between 2D and 3D.
- 3 [Main Menu]** ➔ (p. 36)
 - Press to access Picture, Sound, Network, Timer and Setup Menus.
- 4 Information** ➔ (p. 19)
 - Displays channel and programme information.
- 5 VIERA TOOLS** ➔ (p. 35)
 - Displays some special feature icons and accesses easily.

- 6 INTERNET ([VIERA Connect])** ➔ (p. 18, 69)
 - Displays VIERA Connect home screen.
- 7 OK**
 - Confirms selections and choices.
 - Press after selecting channel positions to quickly change channel.
 - Displays the Channel List.
- 8 [Option Menu]** ➔ (p. 20)
 - Easy optional setting for viewing, sound, etc.
- 9 Coloured buttons**
 - Used for the selection, navigation and operation of various functions.
- 10 Sound Mute**
 - Switches sound mute on or off.
- 11 Teletext*** ➔ (p. 23)
 - Switches to teletext mode.
- 12 Volume Up / Down**
- 13 Numeric buttons**
 - Changes channel and teletext pages.
 - Sets characters.
 - When in Standby mode, switches TV on.
- 14 Aspect** ➔ (p. 21)
 - Changes aspect ratio.
- 15 Light**
 - Lights the buttons for about 5 seconds (except the buttons "25").
- 16 Input mode selection**
 - TV - switches TV mode. ➔ (p. 19)
 - AV - switches to AV input mode from Input Selection list. ➔ (p. 25)
- 17 Exit**
 - Returns to the normal viewing screen.
- 18 [Media Player]** ➔ (p. 52)
 - Switches to SD Card and USB device viewing / listening mode.
- 19 Cursor buttons**
 - Makes selections and adjustments.
- 20 Return**
 - Returns to the previous menu / page.
- 21 Sound Selection**
 - Changes multiplex sound mode (if available). ➔ (p. 81)
- 22 Favourite Page*** ➔ (p. 23)
 - Calls up the teletext page stored in blue button.
- 23 Channel Up / Down**
- 24 Last view** ➔ (p. 22)
 - Switches to previously viewed channel or input mode.
- 25 Operations for contents, connected equipment, etc.** ➔ (p. 26, 52, 66, 75)

* Some countries do not provide a teletext service.

Indicator / Control panel

DT50 series

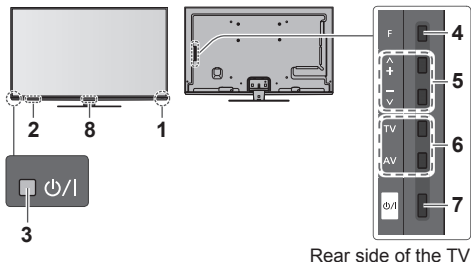

ET50 series

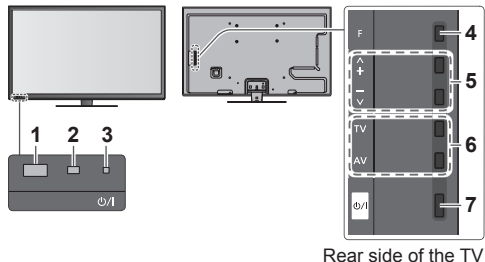

Identifying Controls

1 Remote control signal receiver

- Do not place any objects between the TV remote control signal receiver and remote control.

2 C.A.T.S. (Contrast Automatic Tracking System) sensor

- Senses brightness to adjust picture quality when [Eco Mode] in the Picture Menu is set to [On].
- ➔ (p. 38)

3 Power LED

Red: Standby
Green: On

- The LED blinks when the TV receives a command from the remote control.

4 Function select

- [Volume] / [Backlight] / [Contrast] / [Brightness] / [Colour] / [Sharpness] / [Tint] (NTSC signal) / [Bass]* / [Treble]* / [Balance] / [Auto Tuning] * [Music] or [Speech] mode in the Sound Menu

- Channel Up / Down, Value change (when using the F button), Switching the TV on

6 Changes the input mode

7 Mains power On / Off switch

- Use to switch the mains power.
- If you turned the TV off during Standby mode by the remote control last time, the TV will be in Standby mode when you turn the TV on with Mains power On / Off switch.

8 Front Logo LED (DT50 series)

- To turn the LED on / off, set [Front Logo LED] in Setup Menu. ➔ (p. 42)
- When pressing the control panel button (4 - 7), the control panel guide appears on the right side of the screen for 3 seconds to highlight the pressed button.

Using the On Screen Displays - Operation guide

Many features available on this TV can be accessed via the On Screen Display menu.

■ Operation guide

Operation guide will help you to operate by using the remote control.

Example: [Sound Menu]

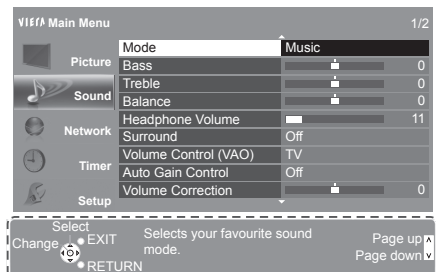

Operation guide

■ How to use remote control



Open the main menu



Move the cursor / select from a range of options / select the menu item (up and down only) / adjust levels (left and right only)



Access the menu / store settings after adjustments have been made or options have been set

RETURN



Return to the previous menu

EXIT



Exit the menu system and return to the normal viewing screen

Auto power standby function

The TV will automatically go into Standby mode in the following conditions:

- No signal is received and no operation is performed for 30 minutes in TV mode.
- [Off Timer] is active in the Timer Menu. (p. 20)
- No operation is performed for the period selected in [Auto Standby] (p. 41).

Basic Connection

External equipment and cables shown are not supplied with this TV.
Please ensure that the unit is disconnected from the mains socket before attaching or disconnecting any leads.
There are some restrictions on placement for viewing 3D images. For details (p. 27, 30)

Terminals

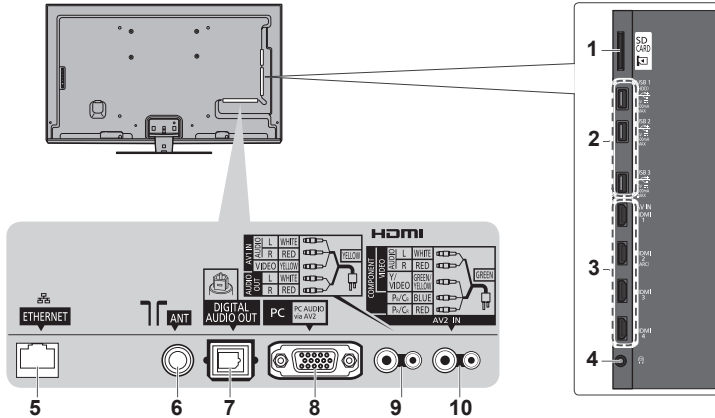

- | | | |
|----------------------------|--------------------------------|--------------------------------|
| 1 SD Card slot → (p. 51) | 5 ETHERNET → (p. 14, 61) | 9 AV1 IN / AUDIO OUT → (p. 77) |
| 2 USB 1 - 3 → (p. 51, 78) | 6 Antenna terminal (see below) | 10 AV2 IN → (p. 77, 78) |
| 3 HDMI 1 - 4 → (p. 13, 77) | 7 DIGITAL AUDIO OUT → (p. 77) | |
| 4 Headphone jack → (p. 78) | 8 PC → (p. 78) | |

Connections

Mains lead and aerial

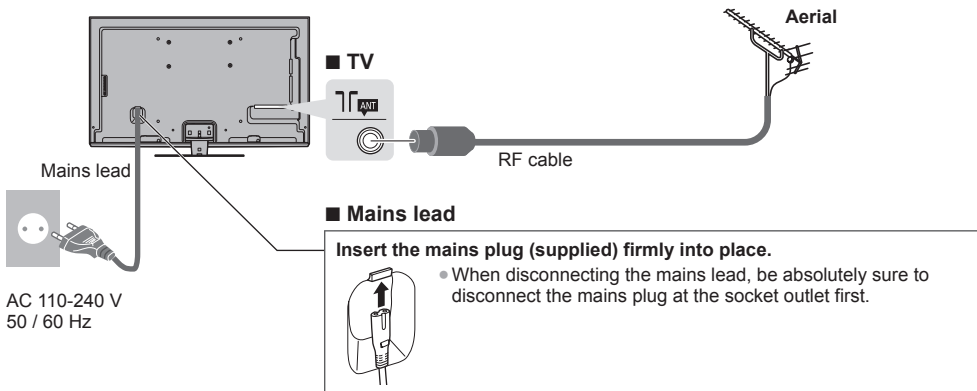

AC 110-240 V
50 / 60 Hz

Note

- Keep RF (antenna) cable away from the mains lead to avoid and minimise mains interference pickup.
- Do not place the RF cable under the TV.
- To obtain optimum quality picture and sound, an aerial, the correct cable (75 Ω coaxial), and the correct terminating plug are required.
- If a communal aerial system is used, you may require the correct connection cable and plug between the wall aerial socket and the TV.
- Your local Television Service Centre or dealer may be able to assist you in obtaining the correct aerial system for your particular area and the accessories required.
- Any matters regarding aerial installation, upgrading of existing systems or accessories required, and the costs incurred, are the responsibility of you, the Customer.

AV devices

■ Player / 3D-compatible player

TV



■ DVD Recorder / VCR

TV

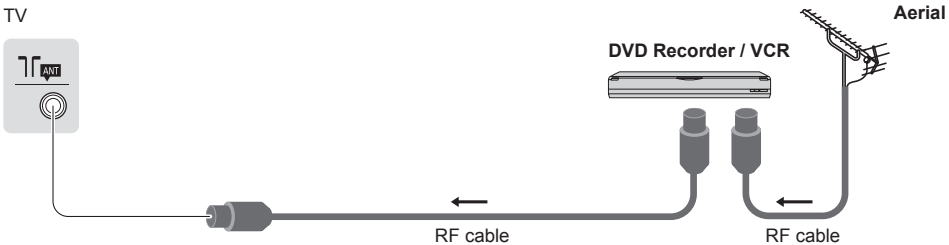

■ Set top box

TV

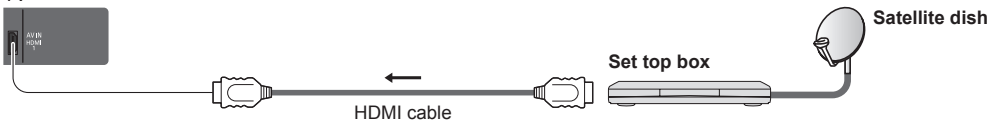

Note

- Check the type of terminals and cable plugs are correct when connecting.
- VIERA Link connection ► (p. 70, 71)
- Please also read the manual of the equipment being connected.
- Keep the TV away from electronic equipment (video equipment, etc.) or equipment with an infrared sensor. Otherwise, distortion of image / sound may occur or operation of other equipment may be interfered.
- When using a HDMI cable, use the fully wired one.

Network

To enable the network service functions (VIERA Connect, etc.), you need to connect the TV to a broadband network environment.

- If you do not have any broadband network services, please consult your retailer for assistance.
- Prepare the internet environment for wired connection or wireless connection.
- Setup of the network connection will start after the tuning (when first using the TV). ➔ (p. 15 - 17)

■ Wired connection

TV

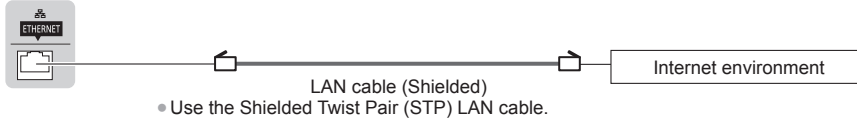

■ Wireless connection

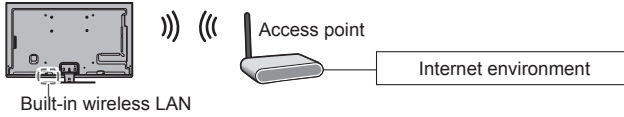

Using clammer

DT50 series

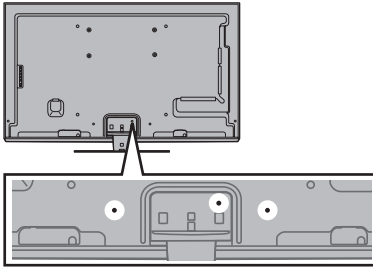

ET50 series

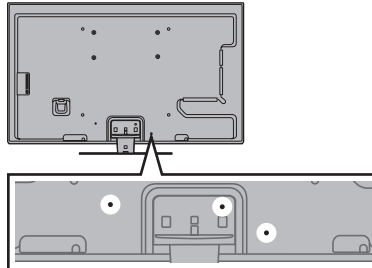

- Do not bundle the RF cable and mains lead together (could cause distorted image).
- Fix cables with clammers as necessary.
- When using the optional accessory, follow the option's assembly manual to fix cables.

■ Clammer (Standard accessory)

<p>Attach the clammer</p> <p>hole</p> <p>Insert the clammer in a hole</p>	<p>Bundle the cables</p> <p>①</p> <p>② Set the tip in the hooks</p> <p>hooks</p>
<p>To remove from the TV:</p> <p>①</p> <p>②</p> <p>snaps</p> <p>① Keep pushing both side snaps</p>	<p>To loosen:</p> <p>②</p> <p>①</p> <p>knob</p> <p>① Keep pushing the knob</p>

Auto Tuning

Search and store TV channels automatically.

- These steps are not necessary if the setup has been completed by your local dealer.
- Please complete connections (p. 12 - 14) and settings (if necessary) of the connected equipment before starting Auto Tuning. For details of settings for the connected equipment, read the manual of the equipment.

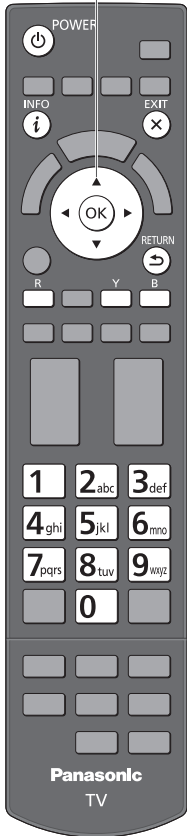
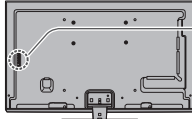

1 Plug the TV into mains socket and switch on



- Takes a few seconds to be displayed.
- If the red LED shows on the TV, press the Standby On / Off switch on the remote control.

2 Select your language

OSD Language		
English	ภาษาไทย	العربية
中文	Tiếng Việt	فارسي
हिन्दी	Indonesia	Français

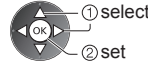

3 Select your country

Country	
Thailand	Vietnam
India	Malaysia
Singapore	Indonesia
United Arab Emirates	Saudi Arabia
Kuwait	Others

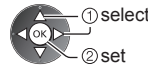

4 Select your area

Channel Plan
Asia/W.Europe
CIS/E. Europe
China
Hong Kong
NZ/Indonesia
CATV/Other



- When selecting [CATV/Other], press the OK button, and then select the Channel Plan from Indian CATV, South Africa, American System, American CATV or Japan CATV.

Auto Tuning starts

- Auto Tuning will start to search for TV channels and store them. The stored channels and sorted channel order vary depending on the area, broadcasting system and conditions of signal reception.



5 Setup the network connection

Setup the network connection to enable the network service functions such as VIERA Connect, etc. (p. 18, 60).

- Please note that this TV does not support wireless public access points.
- Ensure the network connections (p. 14) and network environment are completed before starting setup.

Select the network type



- [Wired] → "Wired connection" (p. 14)
- [Wireless] → "Wireless connection" (p. 14)



- To setup later on or skip this step

→ Select [Set later] or (EXIT)

5

[WPS(Push button)]

1. Press the WPS button on the access point until the light flashes
2. Connect the TV with the access point

WPS(Push button)

- 1) Please press the 'WPS' button on the wireless access point until its light flashes.
- 2) When the light is flashing select 'Connect' on TV.

If you are unsure, please check the instruction manual of the wireless access point.

Connect



- Ensure that your access point supports WPS for this setup.
- WPS: Wi-Fi Protected Setup™
- If the connection has failed, check the settings and positions of your access point. And then, follow the on-screen instructions.

3. After the access point setting is finished, perform the connection test



Connection Test

- Check wireless network connection.
- Check acquired IP address.
- Check for devices using same IP address.
- Check gateway connection.
- Check server connection.

: **succeeded**

The test is successful and the TV is connected to the network.

: **failed**

Check the settings and connections. And then select [Retry].

4. Go to the next step **6**



(Press twice)

6

Select [Home]

Select [Home] viewing environment to use in your home environment.

Please select your viewing environment.

Home Shop



- ① select
- ② set

■ [Shop] viewing environment (for shop display only)

[Shop] viewing environment is the demonstration mode to explain main features of this TV.

Select [Home] viewing environment to use in your home environment.

- You can return to viewing environment selection screen at the stage of Shop confirmation screen.

1 Return to viewing environment selection screen

Shop

You have selected shop mode

RETURN



2 Select [Home]

Please select your viewing environment.

Home Shop



- ① select
- ② set

To change viewing environment later on, you will need to initialise all settings by accessing Shipping Condition. ➔ [Shipping Condition] (p. 47)

Auto Tuning is now complete and your TV is ready for viewing

If tuning has failed, check the connection of the RF cable, and then, follow the on-screen instructions.

Note

- To edit or hide (skip) channels ➔ "Tuning and Editing Channels" (p. 43 - 45)
- To retune all channels ➔ [Auto Tuning] in "Tuning and Editing Channels" (p. 44, 45)
- To initialise all settings ➔ [Shipping Condition] (p. 47)

Using “VIERA Connect”

VIERA Connect is a gateway to the internet services unique to Panasonic. VIERA Connect allows you to access some specific websites supported by Panasonic, and enjoy internet contents such as videos, games, communication tools, etc. from VIERA Connect home screen.

- Some features of the websites may not be available.



1 Turn power on



POWER

- Mains power On / Off switch should be on. (p. 11)

- Every time you turn on the TV, VIERA Connect introduction banner appears. The banner is subject to change.

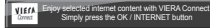

2 Access VIERA Connect

While the banner is displayed



or



- Depending on the usage conditions, it may take a while to read all the data.
- Messages might be displayed before VIERA Connect home screen.

Please read these instructions carefully and follow the on-screen instructions.

Example: VIERA Connect home screen



- To go to the next level, select [MORE].
- To back to the previous level, select [BACK].
- To return to VIERA Connect home screen



■ To exit from VIERA Connect



- To set the VIERA Connect introduction banner display off
➔ [VIERA Connect Banner] (p. 41)

Using “VIERA Connect”

- Video communication requires an exclusive Communication Camera TY-CC20W.
➔ “Optional accessories” (p. 6)
For details, read the manual of the Communication Camera.
- You can connect a keyboard and a gamepad via USB port for character input and playing games in VIERA Connect. You can also operate the TV with a keyboard or a gamepad other than VIERA Connect features.
For more information ➔ “USB connection” (p. 87)

Note

- If you cannot access VIERA Connect, check the network connections (p. 14) and settings (p. 15 - 17).
- For more information of VIERA Connect ➔ (p. 69)

Watching TV

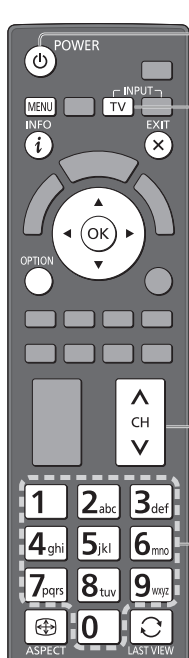

1
2
3

Turn power on



POWER • Mains power On / Off switch should be on. (p. 11)

■ VIERA Connect introduction banner appears

Every time you turn on the TV, this banner appears at the bottom of the screen.

You can access to VIERA Connect easily and enjoy the various contents. ➔ (p. 18)

- To remove this banner, leave for about 5 seconds or press any buttons (except the buttons to access VIERA Connect).
- To set this banner display off ➔ [VIERA Connect Banner] (p. 41)
- The banner is subject to change.



Select TV mode



3

Select a channel



up
or
down

• To select the two-digit channel position number, e.g. 39



Watching TV

Other useful functions

Display Information banner

Display Information banner

INFO • Also appears when changing a channel.



- ⊞, I, II, ▽ Audio mode (p. 81)
- 🔇 Sound mute On

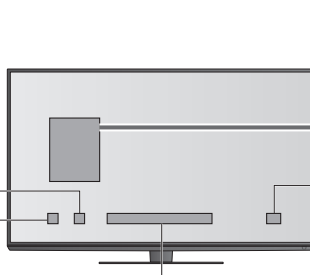

- TV — Input mode
- 1 — Channel position
- CH08 — Channel number
- 5.5MHz — Sound system
- PAL — Colour system
- 16:9 — Aspect ratio
- 1 - 90 — Off Timer remaining time
- For settings ➔ (p. 20)

• To hide ➔

Teletext
(varies depending on the broadcasters)
Teletext service available

Display the selectable settings for the current status

Confirm or change the current status instantly

OPTION

- To change

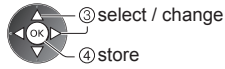

[Channel Colour Set]

Sets colour density

➔ (p. 38)

[Teletext Character Set]

Sets the teletext language

➔ (p. 41)

[MPX]

Selects multiplex sound mode (if available)

➔ (p. 40)

[Volume Correction]

Adjusts volume of individual channel or input mode

Off Timer

Turn the TV to Standby mode automatically after a fixed period

1 Display the menu

MENU

2 Select [Timer]



3 Select [Off Timer] and set the time in 15-minute increments

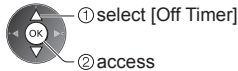
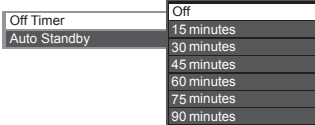

- To cancel, set to [Off] or turn the TV off.
- To confirm the remaining time ➔ “Display Information banner” (p. 19)
- When the remaining time is within 3 minutes, the remaining time will flash on the screen.

Aspect

Change the aspect ratio (image size)

1 Display Aspect Selection list

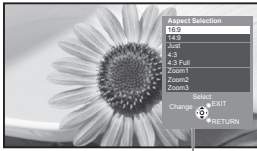

Aspect Selection list

2 While the list is displayed, select the mode



- You can also change the mode only using the ASPECT button.



[16:9]

Directly displays the image at 16:9 without distortion (anamorphic).



[14:9]

Displays the image at the standard 14:9 without distortion.



[Just]

Displays a 4:3 image full-screen. Stretching is only noticeable at the left and right edges.

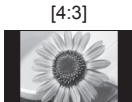

[4:3]

Displays the image at the standard 4:3 without distortion.



[4:3 Full]

Displays a 4:3 image enlarged horizontally to fit the screen.
• For HD signal



[Zoom1]

Displays a 16:9 letterbox or 4:3 image without distortion.



[Zoom2]

Displays a 16:9 letterbox (anamorphic) image full-screen without distortion.



[Zoom3]

Displays a 2.35:1 letterbox (anamorphic) image full-screen without distortion.
At 16:9, displays the image at its maximum (with slight enlargement).

Note

- Only [16:9] and [4:3] are available in PC input mode.
- Aspect cannot be changed in teletext service and 3D mode.
- Aspect mode can be memorised separately for SD (Standard definition) and HD (High definition) signals.

Last view

Switch to previously viewed channel or input mode easily



- Press again to return to the current view.

Note

- Watching less than 10 seconds is not regarded as the previously viewed channel or input mode.

Change OSD language

You can change language for on-screen displays.

1 Display the menu



2 Select [Setup]



3 Select [OSD Language]

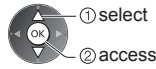

4 Select the language and set

OSD Language		
English	العربية	العربية
中文	Tiếng Việt	فارسی
हिन्दी	Indonesia	Français

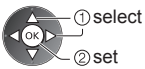

Watching TV

Viewing Teletext

Teletext services are the text information provided by the broadcasters. The features may vary depending on the broadcasters.

What is FASTEXT mode?

In FASTEXT mode, four differently coloured subjects are situated at the bottom of the screen. To access more information about one of these subjects, press the appropriate coloured button. This facility enables fast access to information on the subjects shown.

What is List mode?

In List mode, four differently coloured page numbers are situated at the bottom of the screen. Each of these numbers can be altered and stored in the TV's memory. ➔ **"Store frequently viewed pages"** (p. 24)

■ To change mode ➔ [Teletext] (p. 41)

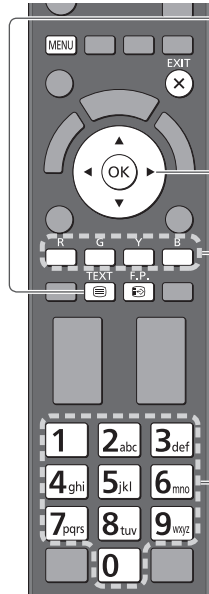

1 Switch to Teletext



Sub page number

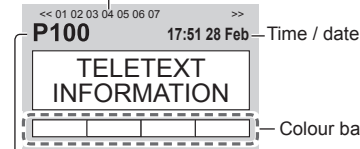

Current page number

- Displays the index page (content varies depending on the broadcasters).

2 Select the page



- or Coloured button (Corresponds to the colour bar)

■ To adjust contrast



(Press three times)

As the blue bar is displayed



■ To return to TV



Reveal hidden data

Reveal hidden words e.g. quiz page answers



- Press again to rehide.

Call up a favourite page

View a favourite page stored

Call up the page stored on the blue button (List mode).

- Factory setting is "P103".



FULL / TOP / BOTTOM

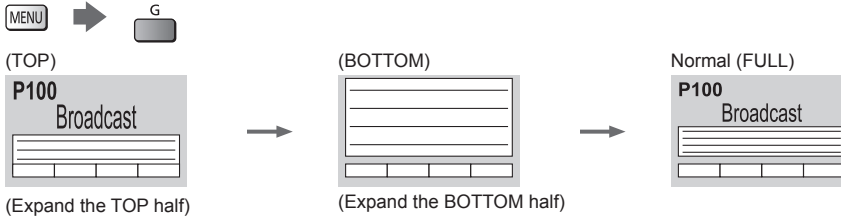

View in multi window

Watch TV and Teletext in two windows at once



- Operations can be made only in teletext screen.

Store frequently viewed pages

Store frequently viewed pages in the colour bar (List mode only)

As page is displayed

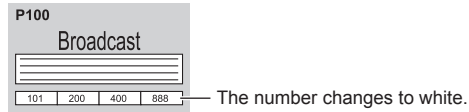

■ To change stored pages

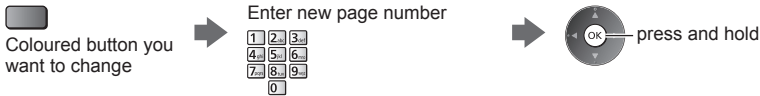

View sub page

View sub page (Only when Teletext is more than one page)



- The number of sub pages varies depending on the broadcasters.
- It may take some time for searching, during which time you can watch TV.

■ To view specific sub page



Watch TV while waiting for update

View the TV picture while searching for a teletext page

Teletext automatically updates itself when new information becomes available.

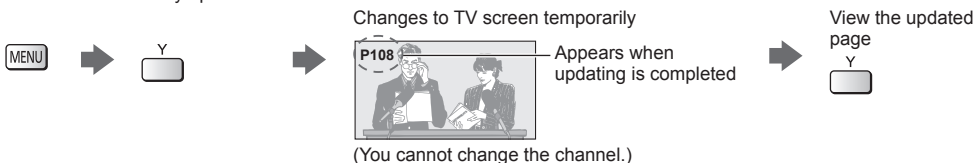

- The news page provides a function that indicates arrival of the latest news ("News Flash").

Watching External Inputs

Connect the external equipment (VCRs, DVD equipment, etc.) and you can watch through the input.

- To connect the equipment → (p. 12 - 14, 77 - 79)

The remote control is capable of operating the contents or external equipment. → (p. 26)

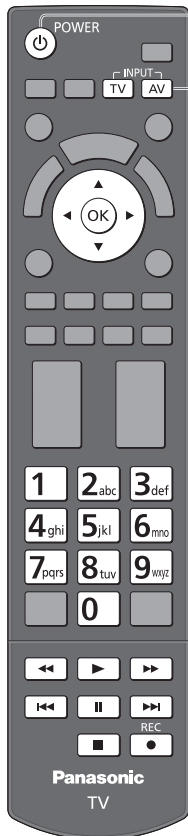

■ To return to TV



1 Turn the TV on



If input mode is not switched automatically

Perform **2** and **3**

- Check the setup of the equipment.

2 Display the input selection menu



3 Select the input mode connected to the equipment

Input Selection
AV1
AV2
PC
HDMI1
HDMI2
HDMI3
HDMI4
TV
SD Card/USB



- You can also select the input using the AV button on the remote control or the TV (except [SD Card/USB]). Press the button repeatedly until the desired input is selected.
- To switch between [COMPONENT] and [VIDEO] in [AV2], move the indicator by pressing left and right cursor button.
- [SD Card/USB]: Switches to Media Player. → **“Using Media Player” (p. 51)**
- You can label or skip each input mode (except [SD Card/USB]). → **“Input Labels” (p. 41)**
Skipped inputs will not be displayed when the AV button is pressed.

4 View

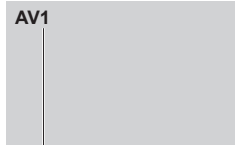









Displays the selected mode

Note

- If the external equipment has an aspect adjustment function, set it to [16:9].
- For details, read the manual of the equipment or ask your local dealer.

Operating contents or the equipment with the TV remote control



You can operate the contents in Media Player / media servers, recording functions or the connected equipment.

	Play Playback videocassette / DVD / video content
	Stop Stop the operations
	Rewind / Search VCR: Rewind, view the picture rapidly in reverse DVD / video content: Press and hold to search backward
	Skip DVD / video content: Skip to the previous track, title or chapter
	Fast-forward / Search VCR: Fast-forward, view the picture rapidly forward DVD / video content: Press and hold to search forward
	Skip DVD / video content: Skip to the next track, title or chapter
	Pause Pause / Resume
	Record Start recording

Watching External Inputs

How to change the code

Each type of the Panasonic equipment has its own remote control code.
Change the code according to the equipment you want to operate.

Press and hold  **POWER** during the following operations
Enter the appropriate code, see table below  → 

Type of the equipment, features	Code
DVD Recorder, DVD Player, Blu-ray Disc Player	70
Player theatre, Blu-ray Disc theatre	71
VCR	72
Using in Video mode of Media Player ➔ (p. 52) Using in Video mode of DLNA ➔ (p. 66) The equipment using in VIERA Link ➔ (p. 75)	73 (default)

Note

- Confirm if the remote control works correctly after changing the code.
- The codes may be reset to default values if batteries are replaced.
- Some operations may not be possible on some equipment models.

Viewing 3D images

You can enjoy viewing 3D images with contents or programmes corresponding to the 3D effect by wearing the 3D Eyewear (supplied). ➔ **“Standard accessories” (p. 6)**

This TV supports [Frame Sequential]*1, [Side by Side]*2 and [Top and Bottom]*3 3D formats.

*1: The 3D format that the images for the left and right eyes are recorded with the high definition quality and alternately played back.

*2, *3: Other available 3D formats

• How to view the 3D images ➔ **(p. 32)**

Warning

Small Parts

• 3D Eyewear contains small parts (battery, etc.) and must be kept out of reach of small children to avoid accidental ingestion.

Disassembly

• Do not disassemble or modify the 3D Eyewear.

Lithium Battery

• Batteries must not be exposed to excessive heat such as sunshine, fire or the like.

Caution

To use 3D Eyewear safely and comfortably, please read these instructions fully.

3D Eyewear

- Do not drop, exert pressure on, or step on the 3D Eyewear.
- Be careful of the tips of the frame when putting on the 3D Eyewear.
- Always keep the 3D Eyewear in a cool, dry place.
- Be careful not to trap a finger in the hinge section of the 3D Eyewear.

Viewing 3D Content

- Do not use the 3D Eyewear if you have a history of over-sensitivity to light, heart problems, or have any other existing medical conditions.
 - Please stop using the 3D Eyewear immediately, if you feel tired, are not feeling well or experience any other uncomfortable sensation. When you set the effect by using [3D Adjustment], take into account that the vision of 3D images varies among different individuals.
 - Take an appropriate break after viewing a 3D movie.
 - Take a break of between 30 - 60 minutes after viewing 3D content on interactive devices such as 3D games or computers.
 - Be careful not to strike the TV screen or other people unintentionally. When using the 3D Eyewear the distance between the user and screen can be misjudged.
 - The 3D Eyewear must only be worn when viewing 3D content.
 - Use the 3D Eyewear where there is no interference from other devices with Bluetooth signal.
 - If you suffer from any eyesight problems (short / far-sighted, astigmatism, eyesight differences in left and right), please ensure to correct your vision before using the 3D Eyewear.
 - Stop using the 3D Eyewear if you can clearly see double images when viewing 3D content.
 - Do not use the 3D Eyewear at a distance less than the recommended distance.
- The recommended viewing distance is at least 3 times of the image height.

For a 42-inch television, 1.6 m or more.

For a 47-inch television, 1.8 m or more.

When the top and bottom area of the screen is blackened, such as movies, view the screen at a distance at least 3 times of the height of the actual image. (That makes the distance closer than above recommended figure.)

Caution

3D Eyewear Use

- Pay special attention when children are using the 3D Eyewear. 3D Eyewear should not be used by children younger than about 5 - 6 years old, as a guideline. All children must be fully supervised by parents or guardians who must ensure their safety and health throughout the using 3D Eyewear.
- Before using the 3D Eyewear, ensure no breakable objects surrounding the user to avoid any accidental damage or injury.
- Remove the 3D Eyewear before moving around to avoid falling or accidental injury.
- Use the 3D Eyewear only for the intended purpose and nothing else.
- Do not use 3D Eyewear in the condition of high temperature.
- Do not use if the 3D Eyewear is physically damaged.
- Do not use devices (such as mobile phones or personal transceivers) that emit strong electromagnetic waves near the 3D Eyewear as this may cause the 3D Eyewear to malfunction.
- Stop using the 3D Eyewear immediately if a malfunction or fault occurs.
- Stop using the 3D Eyewear immediately if you experience any redness, pain, or skin irritation around the nose or temples.
- In rare cases, the materials used in the 3D Eyewear may cause an allergic reaction.

Lithium Battery

- Danger of explosion if battery is incorrectly replaced. Replace only with the same or equivalent type.

3D Eyewear

Viewing 3D images

3D Eyewear



- 3D Eyewear can be worn over vision correction glasses.



- Use the Panasonic 3D Eyewear that has this logo and supports Bluetooth® wireless technology.

“Full HD 3D Glasses™” logo indicates products that are compatible with the active shutter 3D glasses technology standards licensed by the Full HD 3D Glasses Initiative. The RF mark on the logo means the wireless system (Bluetooth® wireless technology), and you can use the 3D Eyewear and the TV that have the same mark together.

Storing and cleaning the 3D Eyewear

- Clean using a soft, dry cloth.
- Wiping the 3D Eyewear with a soft cloth that is covered in dust or dirt may scratch the eyewear. Shake off any dust from the cloth before use.
- Do not use benzene, thinner, or wax on the 3D Eyewear, as doing so may cause the paint to peel off.
- Do not dunk the 3D Eyewear in liquid such as water when cleaning.
- Avoid storing the 3D Eyewear in hot or highly humid locations.
- As the liquid crystal shutters (lens) are fragile and easily broken, be very careful when cleaning them.

Part names and functions

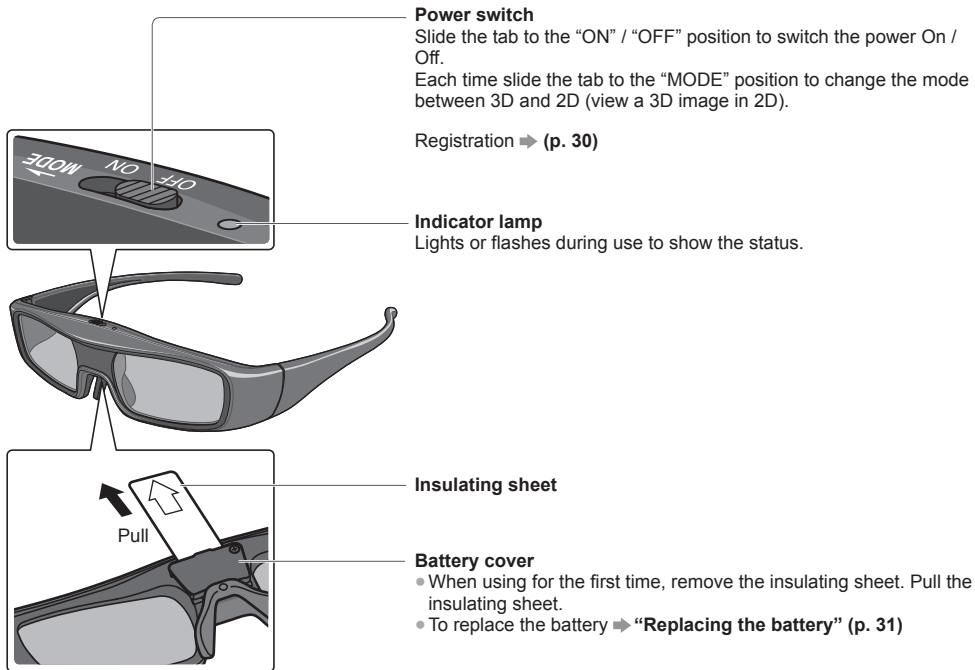

Viewing 3D images

■ Indicator lamp status

Indicator lamp	Status
Lights red for 2 seconds when turned on	Sufficient battery level
Flashes 5 times when turned on	Low battery level
Flashes red and green alternately	Under pairing
Flashes green once every 2 seconds	Under reconnecting to the TV
Lights green for 3 seconds	Pairing or reconnecting is successfully completed.
Flashes red 3 times	Automatically power off (Pairing or connecting fails or connection is lost)
Flashes red once every 2 seconds when in use	3D mode is selected
Flashes red twice every 4 seconds when in use	2D mode is selected

Registration

First registration

Perform the first registration when the 3D Eyewear is used for the first time.

1 Turn on the TV

2 Slide the power switch from “OFF” to “ON”

The 3D Eyewear will power on and start registration.

Place the 3D Eyewear within 50 cm from the TV while registration in progress.

3 The green LED lights on the 3D Eyewear for 3 seconds when the registration is successfully completed

After first registration, the 3D Eyewear will reconnect with TV automatically when 3D Eyewear is powered on near the TV in 3D mode.

Registration again

When connection with registered TV fails, or when using with another TV, re-register the 3D Eyewear.

1 Turn on the TV

2 Within 50 cm from the TV, hold the power switch on the “MODE” position for more than 2 seconds

The registration will start.

3 The green LED lights for 3 seconds when the pairing is successfully completed

Note

- If the registration failed, the 3D Eyewear will power off. In this case, power off the TV and perform from step 1.
- Release the power switch when Registration again starts.

Viewing range for the 3D Eyewear

Viewing 3D images

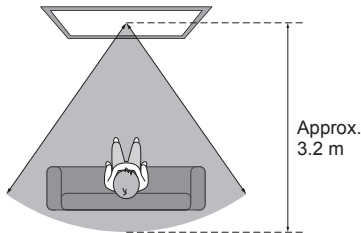

Note

- You cannot view the 3D images with the 3D Eyewear too far from the TV, because of the difficulty of receiving radio waves from the TV.
- The range may be shortened depending on the obstacles between the TV and the 3D Eyewear, or the surrounding environment.
- There are differences in the viewing range of the 3D Eyewear among individuals.
- The 3D Eyewear may not operate correctly at the outside of the viewing range.

Replacing the battery

When the battery is running low, the indicator lamp flashes 5 times on turning the 3D Eyewear on. In this case, early battery replacement is recommended.

- Dispose of the old batteries as non-burnable rubbish, or in line with the waste disposal regulations in your local area.

1 Loosen the screw and remove the cover using with a precision Phillips (No.0, plus +) screwdriver

- The screw is not removed from the cover.

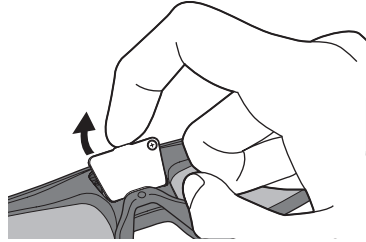
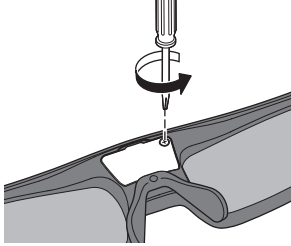

2 Replace the battery

- If difficulty, remove it with the tip of the driver.

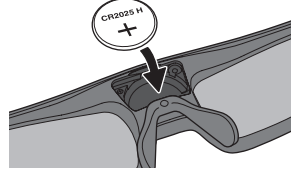
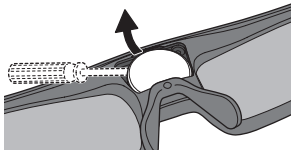

- Use the specified type of battery (coin-shaped lithium battery CR2025).
- Note the correct polarity (+ or -).

3 Replace and fasten the cover

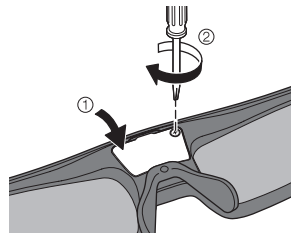
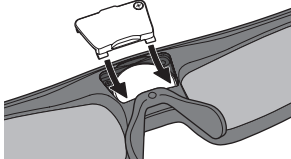

- ① Push the cover firmly until it clicks
- ② Tighten the screw

Viewing 3D images

To view the 3D images

You can enjoy the 3D images in a variety of ways.
(Frame Sequential, Side by Side and Top and Bottom are the supported 3D format.)

■ Playing back 3D-compatible Blu-ray disc (Frame Sequential format)

- Connect the 3D-compatible player via a fully wired HDMI compliant cable.
- If input mode is not switched automatically, select the input mode connected to the player. (p. 25)
- If you use the non 3D-compatible player, the images will be displayed on 2D mode.

■ 3D photos and 3D videos taken by 3D-compatible Panasonic products

- Available in Media Player (p. 53 - 55, 57) and Network services (p. 66, 67)

■ 2D images converted to 3D

- Set to [2D→3D] mode in [3D Mode Selection]. (p. 33)

1 Turn the 3D Eyewear on and put it on

- Connection status and battery status are displayed on the bottom right of the screen.

2 View the 3D images

- Safety precautions will be displayed when you first watch the 3D image. Select [Yes] or [No] to continue to view 3D images.

If you select [Yes], this message will be displayed again in the same condition after Mains power On / Off switch is next turned on. Select [No] if you do not want to display this message again.

- Turn off the 3D Eyewear after using it.

Note

- The 3D image or 3D effect may not be available in the following conditions:
 - VIERA Connect home screen (p. 18) is displayed.
- If light appears to flicker under fluorescents or dimmers when using the 3D Eyewear, change the setting of [3D Refresh Rate] (p. 38).
- 3D content will not be correctly visible if the 3D Eyewear is worn upside down or back-to-front.
- Do not wear the 3D Eyewear when watching anything other than 3D images. Liquid crystal displays (such as computer screens, digital clocks or calculators, etc.) may be difficult to see while wearing the 3D Eyewear.
- Do not use the 3D Eyewear as sunglasses.
- 3D effects may be perceived differently depending on the person.

Changing 2D - 3D mode

You can easily change the viewing mode between 2D and 3D using the 3D button.

- This function is not available in PC mode.



Select the mode

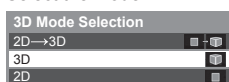

- Items of [3D Mode Selection] vary depending on the condition.

[3D] / [2D] / [2D→3D]:

Displays the appropriate image that you desire without selecting 3D format.

- This mode may not work properly depending on the source image format. In this case, select the appropriate 3D format manually.

■ To change 3D format manually

When the image is not changed properly using [3D], [2D] or [2D→3D] mode, use this manual setting.

During the above operation



Select the mode

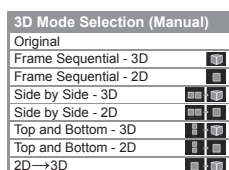

[Original]:

Displays the source image as it is.

- Use to identify the format type of the source image.

➔ "Table of images that can be seen for each [3D Mode Selection (Manual)] and the source image format" (see below)

[Frame Sequential - 3D] / [Frame Sequential - 2D] / [Side by Side - 3D] / [Side by Side - 2D] / [Top and Bottom - 3D] / [Top and Bottom - 2D]:

Displays the mode you select.

- Not valid on TV and AV mode

[2D→3D]:

Converts 2D images into 3D.

- Please note the 3D images appear slightly different from the originals.
- Using this function for profit-making purposes, or publically showing images converted from 2D to 3D in places such as shops or hotels etc. may infringe on the rights of the copyright holder protected under copyright law.

Table of images that can be seen for each [3D Mode Selection (Manual)] and the source image format

If the picture appears to be abnormal, refer to the table below to choose the correct 3D mode.

Source image format	[3D Mode Selection]				
	[Original]	[Frame Sequential - 3D]	[Side by Side - 3D]	[Top and Bottom - 3D]	[2D→3D]
Frame Sequential		 Normal 3D*1			
Side by Side (Full)			 Normal 3D*1		
Side by Side			 Normal 3D*1		
Top and Bottom				 Normal 3D*1	
Normal format (2D)					 Normal 3D

*1: When selecting [Frame Sequential - 2D], [Side by Side - 2D] or [Top and Bottom - 2D], the images will be displayed without 3D effect.

- Depending on the player or broadcasts, the image may be different from the above illustrations.

3D Settings

If the 3D images are not displayed correctly or seem unusual, adjust and setup the 3D settings.

Viewing 3D Images



■ To return to TV



1 Display the menu

MENU

2 Select [Picture]



3 Select [3D Settings]

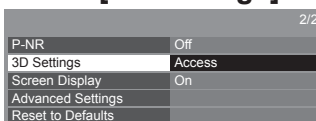

4 Select one of the following functions and set

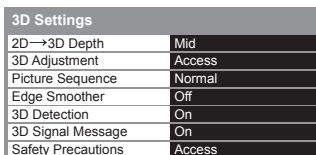

Item	Adjustments / Configurations (alternatives)
2D→3D Depth	Selects a level of 3D-image depth for viewing converted 2D images [Min] / [Mid] / [Max]
3D Adjustment	Adjustment of the 3D effect (except in [2D→3D] mode) [Off] / [On] <ul style="list-style-type: none"> Set to [On] to enable [Effect] setting. When setting to [On], a safety precaution message will appear. Read it carefully and press the RETURN button to go to [Effect] setting. [Effect]: Adjusts the 3D depth according to the contents or to your preference.
Picture Sequence	Select [Reverse] if you feel that the sense of depth is unusual (except in [2D→3D] mode) [Normal] / [Reverse]
Edge Smoother	Set to [On] if you feel the contoured parts of an image are not smooth enough (except in [2D→3D] mode) [Off] / [On]
3D Detection	Automatically detects the 3D format signals [Off] / [On] / [On (Advance)] [On (Advance)]: Detects all the 3D format signals and displays the 3D image automatically. [On]: Detects the particular 3D format signals (Frame Sequential, etc.) and displays the 3D image automatically. <ul style="list-style-type: none"> To view 3D images without any notifications and operations, set to [On (Advance)].
3D Signal Message	Selects whether to give a notification message when a signal of 3D format is found [Off] / [On] <ul style="list-style-type: none"> For Component and HDMI input This function is not available when [3D Detection] is set to [On (Advance)].
Safety Precautions	Displays the precautions for viewing 3D images

Note

- [3D Adjustment] and [Picture Sequence] will not be memorised when changing the input mode or channel.

How to Use VIERA TOOLS

You can access some special features easily by using the VIERA TOOLS function.

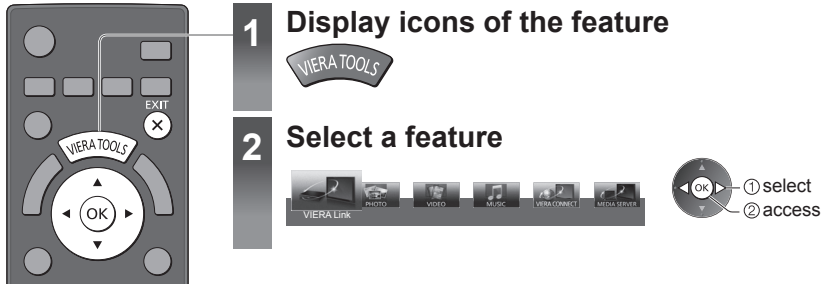

■ To return to TV



■ Follow the operations of each feature



*When two or more available devices are connected, a selection screen will be displayed.
Please select the correct description and access.

Note

- If the selected feature is not available, the demonstration to explain how to use it can be displayed. Press the OK button to view the demonstration after selecting the unavailable feature.

How to Use Menu Functions

Various menus allow you to make settings for the picture, sound, and other functions.

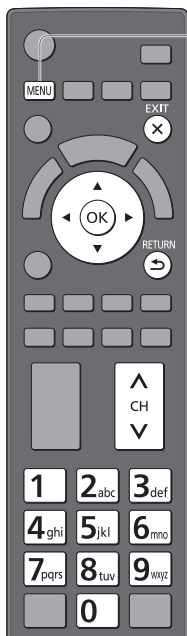

How to Use Menu Functions

■ To return to TV at any time



■ To return to the previous screen



■ To change menu pages

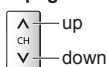

■ Enter characters by free input menu

You can enter names or numbers freely for some items. (English only)



Set characters one by one

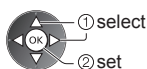

• You can set characters by using numeric buttons. (English only) ➔ “Characters table for numeric buttons” (p. 87)

■ To reset the settings

- Picture or sound settings only
 - ➔ [Reset to Defaults] in the Picture Menu (p. 39) or Sound Menu (p. 40)
- To initialise all settings
 - ➔ [Shipping Condition] (p. 47)

1 Display the menu

[MENU] • Displays the functions that can be set (varies according to the input signal).

2 Select the menu

Example: [Picture Menu]

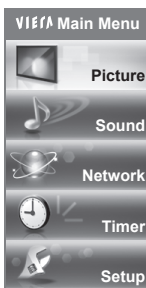

3 Select the item

Example: [Picture Menu]

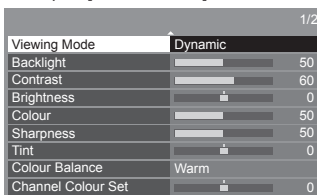

■ Choose from among alternatives



■ Adjust using the slide bar

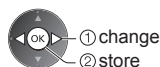

■ Go to the next screen

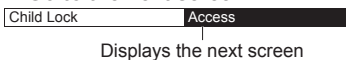

Displays the next screen



Menu list

Menu	Item	Adjustments / Configurations (alternatives)
Picture	Viewing Mode (DT50 series)	<p>Selects your favourite picture mode for each input [Dynamic] / [Normal] / [Cinema] / [True Cinema] / [Game] / [Professional1] / [Professional2]</p> <p>[Dynamic]: Improves contrast and sharpness for viewing in a bright room.</p> <p>[Normal]: Normal use for viewing in a normal lighting condition.</p> <p>[Cinema]: Improves the performance of contrast, black and colour reproduction for watching movies in a darkened room.</p> <p>[True Cinema]: Reproduces the original image quality precisely without any revision.</p> <p>[Game]: Provides suitable images for fast response signal when playing games.</p> <ul style="list-style-type: none"> • Not valid on TV mode • To display a continuous record of time spent using Game mode ➔ [Playing Time Display] (p. 41) <p>[Professional1 / 2]: Allows you to set the professional picture settings in [Advanced Settings], [Lock Settings] and [Copy Adjustment]. ➔ (p. 50)</p> <ul style="list-style-type: none"> • This mode is available only when [Advance(isfcc)] in the Setup Menu is set to [On]. • If the certified professional dealer sets these modes, [Professional1] and [Professional2] may be displayed as [isf Day] and [isf Night]. <hr/> <p>In each Viewing Mode, [Backlight], [Contrast], [Brightness], [Colour], [Sharpness], [Tint], [Colour Balance], [Vivid Colour], [Eco Mode], [P-NR] and [3D-COMB] can be adjusted and stored for each input. Additionally, you can adjust the detailed settings when [Advance(isfcc)] in the Setup Menu is set to [On]. ➔ (p. 42)</p> <ul style="list-style-type: none"> • You can set [Viewing Mode] in 2D and 3D mode for each.
	Viewing mode (ET50 series)	<p>Selects your favourite picture mode for each input [Dynamic] / [Normal] / [Cinema] / [True Cinema] / [Game]</p> <p>[Dynamic]: Improves contrast and sharpness for viewing in a bright room.</p> <p>[Normal]: Normal use for viewing in a normal lighting condition.</p> <p>[Cinema]: Improves the performance of contrast, black and colour reproduction for watching movies in a darkened room.</p> <p>[True Cinema]: Reproduces the original image quality precisely without any revision.</p> <p>[Game]: Provides suitable images for fast response signal when playing games.</p> <ul style="list-style-type: none"> • Not valid on TV mode • To display a continuous record of time spent using Game mode ➔ [Playing Time Display] (p. 41) <hr/> <p>In each Viewing Mode, [Backlight], [Contrast], [Brightness], [Colour], [Sharpness], [Tint], [Colour Balance], [Vivid Colour], [Eco Mode], [P-NR] and [3D-COMB] can be adjusted and stored for each input. Additionally, you can adjust the detailed settings when [Advance] in the Setup Menu is set to [On]. ➔ (p. 42)</p> <ul style="list-style-type: none"> • You can set [Viewing Mode] in 2D and 3D mode for each.
	Backlight, Contrast, Brightness, Colour, Sharpness	Adjusts the levels of these options according to your personal preference
	Tint	Adjusts the picture hue to suit your taste <ul style="list-style-type: none"> • For NTSC signal, Component and HDMI input

Menu	Item	Adjustments / Configurations (alternatives)
Picture	Colour Balance <small>(DT50 series)</small>	Sets the overall colour tone of the picture [Cool] / [Normal] / [Warm] <ul style="list-style-type: none"> Not valid when [Viewing Mode] is set to [True Cinema], [Professional1] or [Professional2]
	Colour Balance <small>(ET50 series)</small>	Sets the overall colour tone of the picture [Cool] / [Normal] / [Warm] <ul style="list-style-type: none"> Not valid when [Viewing Mode] is set to [True Cinema]
	Channel Colour Set	Adjusts the suitable colour density from 3 levels for each channel <ul style="list-style-type: none"> Select the channel to adjust and set this function.
	Vivid Colour <small>(DT50 series)</small>	Automatically adjusts colours to vivid ones [Off] / [On] <ul style="list-style-type: none"> Not valid on PC mode Not valid when [Viewing Mode] is set to [Professional1] or [Professional2]
	Vivid Colour <small>(ET50 series)</small>	Automatically adjusts colours to vivid ones [Off] / [On] <ul style="list-style-type: none"> Not valid on PC mode
	Eco Mode	Automatic Brightness Control function Adjusts picture settings automatically depending on ambient lighting conditions [Off] / [On]
	P-NR	Picture Noise Reduction Reduces unwanted picture noise and flicker noise in the contoured parts of a picture [Off] / [Min] / [Mid] / [Max] / [Auto] <ul style="list-style-type: none"> Not valid on PC mode or when [Viewing Mode] is set to [Game]
	3D-COMB	Makes still or slow moving pictures more vivid [Off] / [On] <ul style="list-style-type: none"> Occasionally, while viewing still or slow moving pictures, colour patterning may be seen. Set to [On] to display sharper and more accurate colours. For PAL / NTSC signal reception in TV mode or from composite (except 3D mode)
	3D Settings	Adjusts and sets to view 3D images (p. 34)
	Screen Display	Turns the screen off when you select [Off] / [On] <ul style="list-style-type: none"> The sound is active even if the screen turns off. Press any buttons (except Standby) to turn the screen on. This function is effective in reducing power consumption when listening to the sound without watching the TV screen.
Advanced Settings	Motion Picture Pro	Automatically compensates the picture frame rate and removes juddering movements to make the images smooth [Off] / [Min] / [Mid] / [Max] <ul style="list-style-type: none"> Depending on the contents, images may be noisy. To prevent the noise, change the setting. Not valid on PC mode or when [Viewing Mode] is set to [Game]
	24p Smooth Film	Automatically compensates the picture frame rate to make the 24p source movie images smooth [Off] / [Min] / [Mid] / [Max] <ul style="list-style-type: none"> This is available only for 24p signal input and displayed instead of [Motion Picture Pro]. Not valid on PC mode or when [Viewing Mode] is set to [Game]
	Film Cadence Detection	Improves vertical resolution for movie images [Off] / [On] <ul style="list-style-type: none"> This function is available for the interlaced signal (except in the mode of PC, VIERA Connect or when [Viewing Mode] is set to [Game]).
	3D Refresh Rate	Reduces juddering and flicker noises of the 3D images when using the 3D Eyewear [Auto] / [100Hz] / [120Hz] [100Hz]: If light appears to flicker under fluorescents (or dimmers) of 50 Hz. [120Hz]: If light appears to flicker under fluorescents (or dimmers) of 60 Hz. If flicker noises appear with 50 Hz input signal.

Menu	Item	Adjustments / Configurations (alternatives)
Picture	Advanced Settings	16:9 Overscan Selects the screen area displaying the image [Off] / [On] [On]: Enlarges the image to hide the edge of the image. [Off]: Displays the image in the original size. <ul style="list-style-type: none"> Set to [On] if noise is generated on the edge of the screen. This function is available when aspect is set to [16:9]. This function can be memorised separately for SD (Standard definition) and HD (High definition) signals. Not valid on PC mode or VIERA Connect
		AV Colour System Selects optional colour system based on video signals in AV mode [Auto] / [PAL] / [SECAM] / [M.NTSC] / [NTSC]
		Colour Matrix Selects the suitable colour parameter for SD (Standard definition) or HD (High definition) signal [SD] / [HD] <ul style="list-style-type: none"> This function is available with 480p or 576p input signal from COMPONENT or HDMI terminal.
		DVI Input Setting Changes the black level of the image for HDMI input mode with DVI input signal manually [Normal] / [Full] <ul style="list-style-type: none"> When the DVI input signal from the external equipment (especially from PC) is displayed, the black level may not be suitable. In this case, select [Full]. The black level for HDMI input signal will be adjusted automatically. For HDMI input mode with DVI input signal
	Reset to Defaults Press the OK button to reset the current Picture Viewing Mode of the selected input to the default settings	
Sound	Mode Selects your favourite sound mode for each input [Music] / [Speech] / [User] [Music]: Improves sound quality for watching music videos, etc. [Speech]: Improves sound quality for watching news, drama, etc. <ul style="list-style-type: none"> In Music and Speech modes, you can adjust [Bass] and [Treble] settings, and those settings will be stored for each mode. [User]: Adjusts the sounds manually by using the equaliser to suit your favourite sound quality. <ul style="list-style-type: none"> For the User mode, [Equaliser] will appear on the Sound Menu instead of [Bass] and [Treble]. Select [Equaliser] and adjust the frequency. ➔ [Equaliser] (see below) 	
	Bass Adjusts level to enhance or minimise lower, deeper sound output	
	Treble Adjusts level to enhance or minimise sharper, higher sound output	
	Equaliser Adjusts the frequency level to suit your favourite sound quality <ul style="list-style-type: none"> This function is available when [Mode] is set to [User]. Select the frequency and change the frequency level by using the cursor button. To enhance the bass sound, raise the level of the lower frequency. To enhance the treble sound, raise the level of the higher frequency. To reset the levels of each frequency to the default settings, select [Reset to Defaults] by using the cursor button, and then press the OK button. 	
	Balance Adjusts volume level of right and left speakers	
	Headphone Volume Adjusts the volume of the headphones	

Menu	Item	Adjustments / Configurations (alternatives)
Sound	Surround	<p>Surround sound settings [Off] / [V-Audio] / [V-Audio Surround] / [V-Audio ProSurround] [V-Audio]: Provides a dynamic enhancer of width to simulate improved spatial effects. [V-Audio Surround]: Provides a dynamic enhancer of width and depth to simulate improved spatial effects. [V-Audio ProSurround]: Provides a more progressive enhancer and reverberation to simulate improved spatial effects.</p>
	Volume Control (VAO)	<p>Controls the volume level of the sound output from AUDIO OUT terminals with the TV remote control [TV] / [Audio Out (TV Off)] / [TV and Audio Out] [TV]: Only the volume level of TV speakers is adjustable. [Audio Out (TV Off)]: Only the volume level from AUDIO OUT terminals is adjustable. (The sound of TV speakers is mute.) [TV and Audio Out]: Controls both volume levels together.</p>
	Auto Gain Control	Automatically regulates large sound level differences between channels and inputs [Off] / [On]
	Volume Correction	Adjusts the volume of individual channel or input mode
	Speaker Distance to Wall	<p>Compensates for the low frequency sound due to the distance between the speakers and the wall [Over 30cm] / [Up to 30cm]</p> <ul style="list-style-type: none"> • If the back space between the TV and wall is over 30 cm, [Over 30cm] is recommended. • If the back space between the TV and wall is within 30 cm, [Up to 30cm] is recommended.
	MPX	<p>Selects multiplex sound mode (if available) [Stereo]: Use this normally. [Mono]: When stereo signal cannot be received. [M1] / [M2]: Available while mono signal is transmitted.</p>
	HDMI1 / 2 / 3 / 4 Input	<p>Selects to fit the input signal [Digital] / [Analogue] (p. 86) [Digital]: When sound is carried via the HDMI cable connection [Analogue]: When sound is not carried via the HDMI-DVI adaptor cable connection</p> <ul style="list-style-type: none"> • For HDMI input
	Reset to Defaults	Press the OK button to reset the current Sound Mode, [Balance], [Headphone Volume] and [Surround] to the default settings
Network	Connection Test, Network Connection, Wireless Network Settings, IP/DNS Settings	Sets the network setting to use in your network environment (p. 63, 64)
	Network Link Settings	Sets to control the TV with the devices connected to the network (p. 62)
	Software Update	Checks for available software updates from the Panasonic website
	New Software Message	Selects whether to give a notification message when new software is found via network [Off] / [On]
	Network Status	Displays the network status (MAC Address, current network settings, etc.)

Menu	Item	Adjustments / Configurations (alternatives)	
Timer	Off Timer	Sets the duration of time until the TV automatically goes into Standby mode [Off] / [15] / [30] / [45] / [60] / [75] / [90] (minutes) (p. 20)	
	Auto Standby	Sets the duration of time that the TV will remain on when no operation is performed [Off] / [2] / [4] (hours) <ul style="list-style-type: none"> Automatic input switching with the connected equipment affects this function and time-count will be reset. The notification message will appear 3 minutes before going into Standby mode. 	
Setup	Eco Navigation <small>(DT50 series)</small>	Automatically sets the TV to the most suitable energy-saving mode <ul style="list-style-type: none"> If you press the OK button, the following items are set as below: [Eco Mode], [VIERA Link], [Power off Link], [Standby Power Save], [Power Save] ➔ [On] [Intelligent Auto Standby] ➔ [On (No reminder)] [Auto Standby] ➔ [2 hours] [Front Logo LED] ➔ [Off] 	
	Eco Navigation <small>(ET50 series)</small>	Automatically sets the TV to the most suitable energy-saving mode <ul style="list-style-type: none"> If you press the OK button, the following items are set as below: [Eco Mode], [VIERA Link], [Power off Link], [Standby Power Save], [Power Save] ➔ [On] [Intelligent Auto Standby] ➔ [On (No reminder)] [Auto Standby] ➔ [2 hours] 	
	Child Lock	Applies access control for channels or inputs to prevent unwanted access (p. 46)	
	Tuning Menu	Channel List Edit	Skips the unwanted channels or edits channels (p. 44)
		Auto Tuning	Automatically searches for the receivable channels (p. 44)
		Manual Tuning	Searches for the channels manually (p. 45)
	OSD Language	Changes language for on-screen displays	
	Display Settings	Teletext	Teletext display mode [FASTEXT] / [List] (p. 23)
		Teletext Character Set	Selects teletext language font [English] / [CIS] / [E.Europe] / [Persian]
		Input Labels	Accesses the input labels list to select the label of each input mode or set to skip unconnected one for easier identification and selection in [Input Selection] (p. 25) or banner <ul style="list-style-type: none"> To name each input mode freely, select [User input] and set characters (maximum 10 characters). To skip the input mode, select [Skip].
Banner Display Timeout		Sets how long the Information banner stays on screen [0 (No display)] / [1] / [2] / [3] / [4] / [5] / [6] / [7] / [8] / [9] / [10] (seconds)	
VIERA Connect Banner		Sets the VIERA Connect introduction banner display [Off] / [On] (p. 18, 19)	
Playing Time Display		Set to [On] to display a continuous record of time spent using Game mode in the top right of the screen every 30 minutes [Off] / [On] <ul style="list-style-type: none"> This function is available when [Viewing Mode] is set to [Game] ➔(p. 37) 	

Menu	Item	Adjustments / Configurations (alternatives)
VIERA Link Settings	VIERA Link	Sets to use VIERA Link functions [Off] / [On] (p. 72)
	HDMI Content Type	Automatically adjusts the picture settings according to the received HDMI content via HDMI cable [Off] / [Auto] <ul style="list-style-type: none"> This function is available if the connected equipment supports HDMI Content Type. The content type information will be displayed for several seconds when this function works.
	Power on Link	Sets to use Power on Link functions [Off] / [On] (p. 72)
	Power off Link	Sets to use Power off Link functions [Off] / [On] (p. 72)
	Standby Power Save	Controls the connected equipment to reduce power consumption in Standby [Off] / [On] (p. 73) <ul style="list-style-type: none"> This function is available when [VIERA Link] is set to [On] and [Power off Link] is set to [On].
	Intelligent Auto Standby	Makes non-watched or non-used connected equipment go into Standby mode to reduce the power consumption [Off] / [On (With reminder)] / [On (No reminder)] (p. 73) <ul style="list-style-type: none"> This function is available when [VIERA Link] is set to [On].
Setup	DivX® VOD	Displays DivX VOD registration code (p. 84)
	Advance(isfccc) <small>(DT50 series)</small>	Enables the advanced picture settings [Off] / [On] <ul style="list-style-type: none"> Set to [On] to display the advanced items in the Picture Menu - [Advanced Settings], [Lock Settings] and [Copy Adjustment]. [Copy Adjustment] will be displayed when [Viewing Mode] is set to [Professional1] or [Professional2]. (p. 49) [isfccc] is the picture setting for the certified professional dealer. For details, consult your local dealer.
	Advance <small>(ET50 series)</small>	Enables the advanced picture settings [Off] / [On] <ul style="list-style-type: none"> Set to [On] to display the advanced items in the Picture Menu. (p. 49)
System Menu	Shipping Condition	Resets all settings to the original condition (p. 47)
	Software Licence	Displays the software licence information
	System Information	Displays the system information of this TV
	Device Information	Displays the device information of this TV
Other Settings	USB Charge in Standby	Enables to supply the power from the USB port in Standby mode [Off] / [On] <ul style="list-style-type: none"> Available for charging the rechargeable 3D Eyewear (optional) This function is available when in Standby mode.
	Power Save	Reduces brightness of the picture to economise on power consumption [Off] / [On]
	Front Logo LED <small>(DT50 series)</small>	Lights the Panasonic logo on the TV front while the TV is on [Off] / [On]

- A different menu will be displayed when [Advance(isfccc)] or [Advance] in the Setup Menu is set to [On] or in the mode of PC input, Media Player or network service operations. (p. 48, 51 - 59, 66 - 69)
- Only available items can be selected.

Tuning and Editing Channels

You can retune channels or make your favourite channel lists, skip unwanted channels, etc.

1 Select TV mode

→ (p. 19)

TV

2 Display the menu and select [Setup]

MENU



① select

② access

3 Select [Tuning Menu]



① select

② access

• The displayed item depends on the selected mode.

4 Select one of the following functions

Tuning Menu	
Channel List Edit	Access
Auto Tuning	Access
Manual Tuning	Access



① select

② access

Skip unwanted channels, Edit Channels [Channel List Edit]

You can hide (skip) unwanted channels.
The hidden channels cannot be displayed except in this function.

Select a channel and reveal / hide



To reveal all channels



To edit channels

To move the channel position (if available)

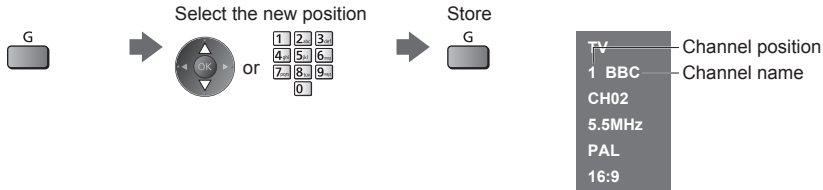

To retune each channel ([Manual Tuning] (p. 45))



To rename the channel name

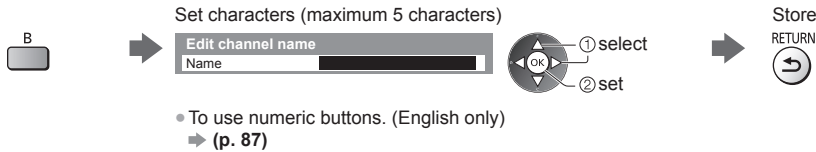

Note

If a VCR is connected only with the RF cable, edit [VCR].

Set all channels automatically [Auto Tuning]

Automatically retune all channels received in the area.

1 Start Auto Tuning

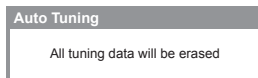

2 Settings are made automatically



- All the previous tuning settings are erased.
- When the operation is completed, the channel at the lowest position will be displayed.
- Search begins in the order from the lower channels to the higher channels.
- If tuning has not been done completely → **[Manual Tuning] (p. 45)**

Set TV channel manually [Manual Tuning]

[Fine Tuning]:

Use to make small adjustments to the tuning of an individual channel (affected by weather conditions, etc.).

[Manual Tuning]:

Set TV channel manually after Auto Tuning.

- Set [Sound System] and [Colour System], and then perform this function. Normally set [Colour System] to [Auto].
- If a VCR is connected only with the RF cable, select channel position [0].



1 Select the channel position



3 Search



2 Select the channel



4 Select [Store]

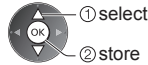

Auto Tuning using the buttons on the TV

For Auto Tuning, using the buttons on the TV (p. 11)

1 Press the F button repeatedly until [Auto Tuning] appears



2 Access [Auto Tuning]



3 Start [Auto Tuning]

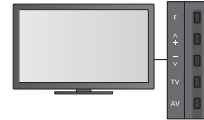

- To return to TV
- 
- Control panel OSD appears when pressing the control panel button.

Child Lock

You can lock specific channels / AV input terminals and control who watches them. When the locked channel / input is selected, a message appears. Enter the PIN number to watch.

1 Display the menu and select [Setup]



2 Select [Child Lock]

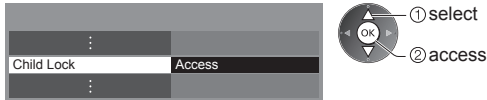

Control channel audience [Child Lock]

1 Enter the PIN number (4 digits)



2 Select [Child Lock List]



3 Select the channel / input to be locked

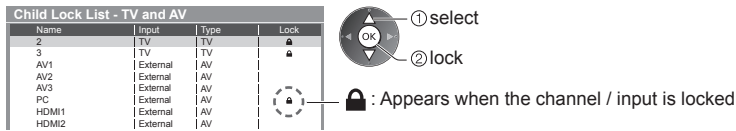

• To cancel

Select the locked channel / input



• To cancel all locks



• To lock all



• To jump to the top of the next input



■ To change the PIN number

1. Select [Change PIN]



2. Enter a new PIN number twice



Note

- Setting [Shipping Condition] (p. 47) erases the PIN number and all settings.

Shipping Condition

Resets the TV to its original condition, i.e. no channels tuned in. All settings are reset (channels, picture, sound settings, etc.).

- To retune TV channels only, e.g. after moving house
➔ [Auto Tuning] in "Tuning and Editing Channels" (p. 44, 45)

1 Display the menu and select [Setup]



2 Select [System Menu]



3 Select [Shipping Condition]

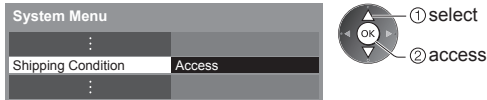

Restore Settings [Shipping Condition]

1 Check the message and initialise

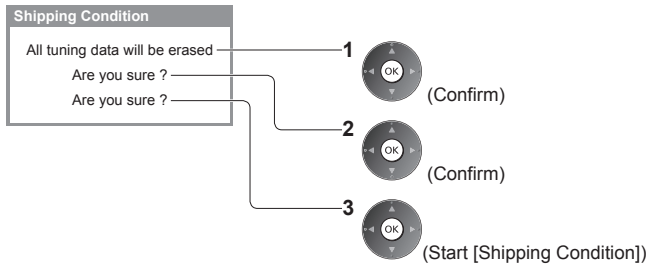

2 Follow the on-screen instructions

Reset to Factory Shipping Condition Completed.
TV will automatically restart.
Do not turn off

- [Auto Tuning] will automatically start. (p. 15)

Displaying PC Screen on TV

The screen of the PC connected to the TV can be displayed on the TV.
You can also listen to PC sound with the audio cable connected.

- To connect PC ➔ (p. 78)

1 Select the external input

AV

2 Select [PC]

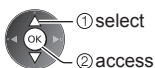
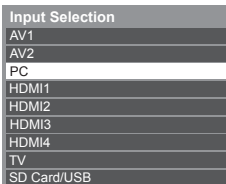

- Corresponding signals ➔ (p. 88)
- If [H-freq.] or [V-freq.] is shown in red, the signals may not be supported.

Displaying PC Screen on TV

PC menu setting

- To make settings ➔ “How to Use Menu Functions” (p. 36)

Menu	Item	Adjustments / Configurations (alternatives)
Setup PC Setup	Input Resolution	Switches to a wide view: VGA (640 × 480 pixels) / WVGA (852 × 480 pixels) / XGA (1,024 × 768 pixels) / WXGA (1,280 × 768 pixels, 1,366 × 768 pixels) • Options change depending on signals
	Clock	Set to the minimum level if noise occurs
	H-pos	Adjusts horizontal position
	V-pos	Adjusts vertical position
	Clock Phase	Eliminates flicker and distortion • Adjust after Clock adjustment • Set to the minimum level if noise occurs
	Sync	Chooses another synchronous signal if the image is distorted [H & V] / [On Green] [H & V]: by the horizontal and vertical signals from your PC [On Green]: by the green signal from your PC (if available)
	Reset to Defaults	Press the OK button to reset [PC Setup] to the default settings

- Other items ➔ (p. 37 - 42, 49)

Note

- For HDMI-compatible PC, possible to connect to HDMI terminals (HDMI1 / HDMI2 / HDMI3 / HDMI4) by using HDMI cable (p. 86).

Advanced Picture Settings

You can adjust and setup the detailed picture settings for each Viewing Mode.

- To use this function completely, set [Advance(isfcc)] or [Advance] to [On] in the Setup Menu. ▶ (p. 42)
- For PC input mode, some functions are available without setting [Advance(isfcc)] or [Advance].

1 Display the menu and select [Picture]



2 Select [Viewing Mode] and set the mode



3 Select one of the following functions



- [Copy Adjustment] is available when [Viewing Mode] in the Picture Menu is set to [Professional1] or [Professional2]. (DT50 series)

Adjust the detailed picture settings [Advanced Settings]

Advanced Settings	
White Balance	Access
Colour Management	Access
Gamma	Access
...	



- [Colour Management] is available when [Viewing Mode] in the Picture Menu is set to [True Cinema], [Professional1] or [Professional2]. (DT50 series)
- [Colour Management] is available when [Viewing Mode] in the Picture Menu is set to [True Cinema]. (ET50 series)

Menu	Item	Adjustments / Configurations (alternatives)
Picture	White Balance	R-Gain, G-Gain, B-Gain Adjusts the white balance of bright red / green / blue area
		R-Cutoff, G-Cutoff, B-Cutoff Adjusts the white balance of dark red / green / blue area
		Reset to Defaults Press the OK button to reset to the default White Balance
	Colour Management	R-Hue, G-Hue, B-Hue Adjusts the picture hue of red / green / blue area
		R-Saturation, G-Saturation, B-Saturation Adjusts the saturation of red / green / blue area
		R-Luminance, G-Luminance, B-Luminance Adjusts the luminance of red / green / blue area
		Reset to Defaults Press the OK button to reset to the default Colour Management
	Gamma	Gamma Switches the gamma curve [1.8] / [2.0] / [2.2] / [2.4] / [2.6] • Please note the numerical values are reference for the adjustment.
		Reset to Defaults Press the OK button to reset to the default Gamma

Lock the picture setting [Lock Settings] DT50 series

[White Balance], [Colour Management] and [Gamma] can be locked for each Viewing Mode and each input. Additionally, [Backlight], [Contrast], [Brightness], [Colour], [Sharpness], [Tint] and [Reset to Defaults] in the Picture Menu can be locked for [Professional1] and [Professional2].

1 Enter the PIN number (4 digits)

Lock Settings-PIN Entry	
Please enter new PIN	
PIN	* * * *



2 Select [Adjustment Lock] and set to [On]

Lock Settings	
Change PIN	
Adjustment Lock	On



- Enter the PIN number twice at first setting.
- Make a note of the PIN number in case you forget it.

■ To change the PIN number

1. Select [Change PIN]

Lock Settings	
Change PIN	Access
Adjustment Lock	On



2. Enter a new PIN number twice



Copy the settings to the other input [Copy Adjustment] DT50 series

You can copy the selected [Professional1] or [Professional2] settings to that of the other input. The settings of [Backlight], [Contrast], [Brightness], [Colour], [Sharpness], [Tint], [White Balance], [Colour Management] and [Gamma] will be copied.

Select the destination to copy to

Copy Adjustment	
Destination	All

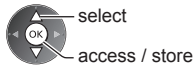

- You cannot copy to the locked mode.

Using Media Player

Media Player allows you to enjoy photo, video or music recorded on an SD Card and a USB Flash Memory. VIERA IMAGE VIEWER is the function of the easy viewing for photos or videos recorded on an SD Card on the TV screen by simply inserting into the SD Card slot.

Photo mode:

Still pictures recorded by digital cameras will be displayed.

Video mode:

Moving pictures recorded by digital video cameras and digital video data will be played back.

Music mode:

Digital music data will be played back.

- During the operation, audio signal is output from AUDIO OUT, DIGITAL AUDIO OUT and HDMI2 (ARC function) terminals. To use HDMI2 with ARC function, connect an amplifier that has ARC function (p. 71) and set to use theatre speakers (p. 76).
- [Date] shows the date on which the recording was made by the recording equipment. The file without record of the date is shown "*****/**/****".
- The picture may not appear correctly on this TV depending on the recording equipment used.
- Display may take some time when there are many files and folders.
- Partly degraded files might be displayed at a reduced resolution.
- Picture setting may not work depending on the conditions.
- The folder and file names may be different depending on the digital camera or digital video camera used.

■ To insert or remove the SD Card / USB Flash Memory

USB Flash Memory

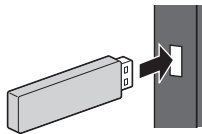

- Insert or remove straightly and completely.
- Connect the USB Flash Memory to the USB 1, 2 or 3 port.
- Check the type of terminals and cable plugs are correct when connecting.

SD Card

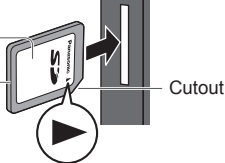
- ① Gently insert the SD Card with the label surface facing front.
 - ② Push until a click is heard. To remove, push it again.
- 

- When connecting a USB device to the USB 1 port, there may be a difficulty to insert / remove the SD Card. In this case, confirm a USB device is not active and insert / remove the SD Card carefully.

- For the information of the devices ➔ **“Devices for playing back” (p. 85)**
- For the supported file format ➔ **“Supported file format in Media Player and media servers” (p. 82, 83)**

Starting Media Player

1 Insert the SD Card or USB Flash Memory to the TV

➔ (p. 51)

- When the SD Card is inserted, switching to Media Player will be done automatically.

2 Start Media Player



- You can also start by pressing following button.

AV ➔ “Watching External Inputs” (p. 25)

3 Select the device to access



① select

② access

- If two or more devices are not connected, this step will be skipped.

Selected device name

4 Select the content

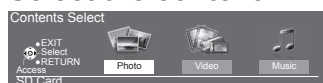

① select

② access

[Photo] ➔ (p. 53)

[Video] ➔ (p. 57)

[Music] ➔ (p. 59)

5 Enjoy Media Player

Example: Thumbnail - [All photos]



- To display the information of the highlighted content



File name	1/48
Date	p1010001.JPG
Pixel	2011/10/23
	1600X1200

File number / Total file number

Selected device name

Note

- You can also access each mode directly by using VIERA TOOLS. ➔ (p. 35)
- Select the appropriate device and content for playing back each file.
- You can use the following buttons during playback.
Confirm the code of the remote control to “73” ➔ (p. 26)



Change the device

You can change to the other device directly in the same mode if two or more devices are connected.

1 While the thumbnail is displayed, display the device selection



2 Select the device to access



① select

② access

Selected device name

Change the contents

You can switch to the other mode of Media Player from the thumbnail view.

- The mode can be switched in the current device.

1 While the thumbnail is displayed, display the contents selection



2 Select the contents



Photo mode

Photo mode will read all “.jpg” extension files and supports “.mpo” extension files in the SD Card or USB Flash Memory.

The thumbnail of all the photos in the SD Card or USB Flash Memory will be displayed.

Example: Thumbnail - [All photos]



- To change the size of photos on a thumbnail screen

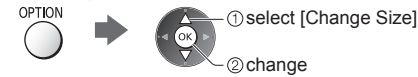

: Error display

[Single view] - Photos are displayed one at a time.

Select the file from the thumbnail of photos to be viewed



Example:



Operation guide

- To display / hide the operation guide



- To return to thumbnail



- To operate Single view

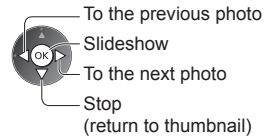

- To rotate 90°



[Slideshow] - Slideshow completes when all photos are viewed within the current thumbnail.

1 Select the file from the thumbnail of photos for the first view



- To display / hide the operation guide



- To change the back ground music → “Photo Settings” (p. 55)

2 Start Slideshow



- To pause (return to Single view)



- To return to thumbnail



■ To sort by folder, recorded date or recorded month

1 Display the view selection in the thumbnail view



2 Select the sort type



[Folder view]:

- Displays the thumbnail grouped by folder.
- The files which are not into a folder will be collected to the folder named "/".

[Sort by Date] / [Sort by Month]:

- Displays the thumbnail grouped by the same date or month.
- The group of the photos without a recorded date is shown as [Unknown].

- To return to the thumbnail of all photos

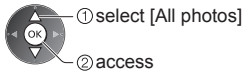

Multi Shot 3D

- This TV can create the 3D photo using a pair of photos in the SD Card and save it into the same SD Card.
- This TV can also create the 3D photo from photos in the USB Flash Memory, but cannot save it.
- This function is available with photos recorded by digital cameras.
- Depending on the photos you select, the created 3D photo may not be suitable or the 3D photo creation may not be possible. It is recommended to take a photo (for L) and then move your camera to the right about 5 cm and take another photo (for R).
- To view the created 3D photo with 3D effect, you need the 3D Eyewear → **"Standard accessories"** (p. 6)

1 Display the option menu in the thumbnail view

OPTION



2 Select [Multi Shot 3D]



3 Select two photos for L (left) and R (right)

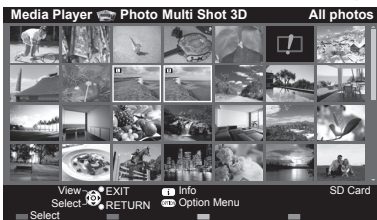

- You can only select photos of the same recorded date and same pixels.
- You may not be able to view the created 3D photo properly if you select the photos for L and R oppositely.

4 Create the 3D photo



- If your selected photos are not suitable for the 3D photo, the error message will be displayed and will return to the photo selection screen (step 3).
- To save the 3D photo in the SD Card

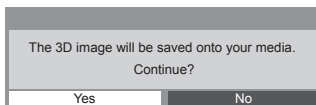

- 1 select [Yes]
- 2 save

After finishing saving the photo, the photo selection screen will be displayed (step 3). Select photos again to create another 3D photo or exit from [Multi Shot 3D] mode.

■ To enjoy the saved 3D photos

Saved 3D photos are displayed in the Thumbnail screen. Wear the 3D Eyewear and enjoy the 3D photos.

Example: Thumbnail



Photo Settings

Setup the settings for Photo mode.

1 Display the option menu

OPTION



2 Select [Slideshow Settings]



3 Select the items and set

Slideshow Settings	
Frame	Off
Colour Effect	Off
Transition Effect	Fade
Screen Mode	Normal
Burst Playback	Off
Interval	5 seconds
Repeat	On
Back Ground Music	



select

access / store

Note

- Picture quality may become lower depending on the slideshow settings.
- Picture setting may not work depending on the slideshow settings.

Menu	Item	Adjustments / Configurations (alternatives)
Slideshow Settings	Frame	<p>Selects the frame type of the slideshow [Off] / [Multi] / [Collage] / [Drift (+ calendar)] / [Drift] / [Gallery (+ calendar)] / [Gallery] / [Cinema] [Multi]: 9 photos are displayed orderly at once. [Collage]: Each photo is displayed at a random position and random scale. [Drift (+ calendar)] / [Drift]: Photos are displayed like flow images. • You can select to display the calendar or not. The month of calendar is turned by pressing the left or right cursor button. [Gallery (+ calendar)] / [Gallery]: The various sizes of photos in the frame are displayed. • You can select to display the calendar or not. The month of calendar is turned by pressing the left or right cursor button. [Cinema]: Photos are displayed like old films (sepia tone).</p>
	Colour Effect	<p>Selects the colour effect of photos on Single view and Slideshow [Off] / [Sepia] / [Gray scale] • This function is not available when [Frame] is set to [Drift], [Gallery] or [Cinema].</p>
	Transition Effect	<p>Selects the transition effect for switching the photo during the slideshow [Off] / [Fade] / [Slide] / [Dissolve] / [Motion] / [Random] [Fade]: The next photo fades in gradually. [Slide]: The next photo slides and appears from the left side. [Dissolve]: Each photo is dissolved when switching to the next photo. [Motion]: Each photo is displayed with an effect of enlarging, reducing, moving up or moving down. [Random]: Each transition is selected at random. • This function is available when [Frame] is set to [Off].</p>

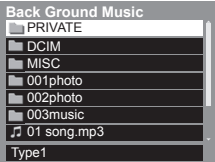
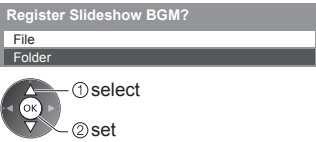
Menu	Item	Adjustments / Configurations (alternatives)
	Screen Mode	<p>Selects enlarged or normal viewing on Single view and Slideshow [Normal] / [Zoom]</p> <ul style="list-style-type: none"> This function is not available when [Frame] is set to [Collage], [Drift], [Gallery] or [Cinema] or when [Transition Effect] is set to [Motion]. Depending on the photo size, it may not be fully enlarged to fill the screen, e.g. portrait style picture.
	Burst Playback	<p>Selects whether to display burst photos in a fast-paced slideshow mode [Off] / [On]</p> <ul style="list-style-type: none"> This function is not available when [Frame] is set to [Drift], [Gallery] or [Cinema] or when [Transition Effect] is set to [Motion].
	Interval	<p>Selects slideshow interval [5] / [10] / [15] / [30] / [60] / [90] / [120] (seconds)</p> <ul style="list-style-type: none"> This function is not available when [Frame] is set to [Drift], [Gallery] or [Cinema] or when [Transition Effect] is set to [Motion].
	Repeat	<p>Slideshow repeat [Off] / [On]</p>
	Back Ground Music	<p>Selects the back ground music during Photo mode [Off] / [Type1] / [Type2] / [Type3] / [Type4] / [Type5] / [User] / [Auto]</p> <ul style="list-style-type: none"> [Type1 - 5] are the fixed music each installed in this TV. <p>[User]: Music data in the device registered by yourself will be played back.</p> <p>To register the music</p> <ol style="list-style-type: none"> Select the music file Depending on the condition of the device, select folders until you reach the desired music file.  <ol style="list-style-type: none"> Select [File] or [Folder]  <p>[File]: The selected music file will be registered. [Folder]: All the music in the folder which contains the selected music file will be registered.</p> <ul style="list-style-type: none"> If no music has been registered or the device which has the registered music is removed, no sound will be produced. <p>[Auto]: Music data stored in the root folder of the current device will be played back randomly. <ul style="list-style-type: none"> If there is no available music data, no sound will be produced. </p>

Video mode

- Supported file format ➔ (p. 82, 83)

The thumbnail of video titles in the SD Card or USB Flash Memory will be displayed.

Example: Thumbnail - [Title view]

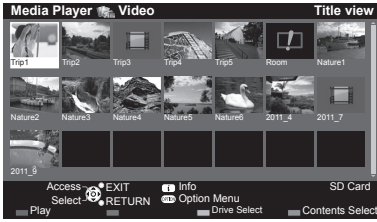

The preview will start when the title / scene is highlighted if it supports a preview.

- To turn off the preview ➔ **“Video Setup” (p. 58)**

- To play back the selected title

If you stopped the last playback on the way, the confirmation screen is displayed to select whether to start from where you stopped last time or from the beginning.



: Error display

: The file does not support thumbnail view.

■ Playback from the selected scene in the title (SD-Video or AVCHD)

Playback of the selected scene will start to the end of the title.

1 Select the title

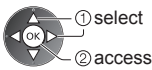

2 Select the scene



3 Start playback



Note

- The structure of titles and scenes may vary depending on the digital video camera used.
- To repeat playback ➔ **“Video Setup” (p. 58)**

■ How to operate in the playback

Example: Playback



Operation guide Information banner

- To display / hide the operation guide and information banner



- To the previous title / scene



- To the next title / scene



- To change aspect



- To return to thumbnail



- To operate the playback

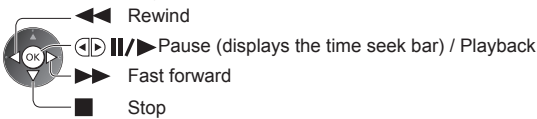

- To jump to the specified time point

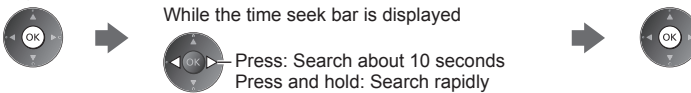

■ Video Setup

Setup the settings for Video mode.

- Menu items and selectable options vary depending on the content.

1 Display the option menu

OPTION



2 Select [Video Setup]



3 Select the items and set



Menu	Item	Adjustments / Configurations (alternatives)
Video Setup	Video Preview	Sets to start the preview of the title or scene in the thumbnail view [Off] / [On] <ul style="list-style-type: none"> • Image may not be displayed for an instant in the thumbnail view. Set the preview [Off] to resolve this. • Only available in the thumbnail view
	Multi Audio, Dual Mono Audio	Selects between selectable sound tracks (if available) <ul style="list-style-type: none"> • It may take several seconds to change the sound. • Only available during playback
	Subtitle	Subtitles On / Off (if available) <ul style="list-style-type: none"> • Only available during playback
	Subtitle Text	Selects the font type to display subtitles correctly (if available) <ul style="list-style-type: none"> • Only available during playback
	Aspect Change	[Aspect1]: Displays the content enlarged without distortion. [Aspect2]: Displays the content full-screen. [Original]: Displays the content original size. <ul style="list-style-type: none"> • You can also change the aspect using the ASPECT button. • Aspect change may not work depending on the content. • Only available during playback
	Repeat	Playback repeat within the title or selected file (depending on the content) [Off] / [On]
	Title	Selects from a group of titles (if available)

Using Media Player

Audio output Settings

You can enjoy the multi-channel sound via an amplifier connected to DIGITAL AUDIO OUT or HDMI2 (ARC function) terminal.

- To confirm or change the current sound status (see above)

1 Display the menu and Select [Sound]

MENU



2 Select [SPDIF Selection] and set

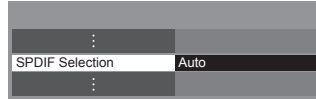

Menu	Item	Adjustments / Configurations (alternatives)
Sound	SPDIF Selection	SPDIF: A standard audio transfer file format Selects the initial setting for digital audio output signal from DIGITAL AUDIO OUT and HDMI2 (ARC function) terminals [Auto] / [PCM] [Auto]: Dolby Digital Plus, Dolby Digital and HE-AAC multi-channel are output as Dolby Digital Bitstream. DTS is output as DTS. MPEG is output as PCM. [PCM]: Digital output signal is fixed to PCM.

Music mode

- Supported file format ➔ (p. 83)

The thumbnail of music folders in the SD Card or USB Flash Memory will be displayed.

Example: Thumbnail - [Folder view]

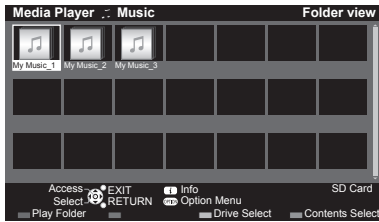

- To play back the selected folder
Select the folder



- Start playback



■ Playback from File view

Selected file will be played back.

1 Select the folder



① select

② access

2 Select the file



3 Start playback



■ How to operate in the playback

Example: Playback

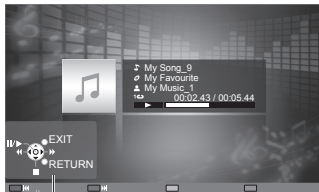

Operation guide

- To display / hide the operation guide



- To the previous track



- To operate the playback



◀◀ Rewind

⏸ Pause / Playback

▶▶ Fast forward

■ Stop

- To the next track



- To return to thumbnail



Music Setup

Setup the setting for Music mode (only available in the thumbnail view).

1 Display the option menu

OPTION



2 Select [Music Setup]



3 Set

select



access / store

Using Network Services (DLNA / VIERA Connect)

DLNA®

This TV is a DLNA Certified™ product.

DLNA (Digital Living Network Alliance) is a standard that makes DLNA Certified digital electronics easier and more convenient to use on a home network. To learn more, visit www.dlna.org.

It allows you to share photos, videos (including 3D images) and music stored in the DLNA Certified media server (for example, PC with Windows 7 installed, etc.) connected to your home network, and enjoy the contents on the TV screen.

It also allows you to control the TV with the DLNA Certified equipment connected to your home network. (DLNA Remote Control)

- For the supported file format ➔ (p. 82, 83)
- AVCHD and DivX files are not supported by DLNA functions of this TV, but can be played by Media Player (p. 51).

■ Media server

Store photos, videos or music into the DLNA Certified media server, and then you can enjoy them on the TV.

To use a PC as a media server

Prepare the PC with Windows 7 or ensure the server software is installed on the PC.

"Windows 7" and "TwonkyMedia server 6 (installed on the PC with Windows 7, Windows Vista or Windows XP)" are the server software that has been tested for compatibility with this TV (as of January, 2011). Any other server software have not been tested with this TV, therefore compatibility and performance cannot be assured.

- Windows 7
The setup for homegroup settings of Windows 7 is required. For details, refer to the help functions of Windows 7.
- TwonkyMedia server

"TwonkyMedia server" is the product of PacketVideo Corporation.

To obtain the Installation Guides for installing and setting "TwonkyMedia server", visit the website of TwonkyMedia. Additional fees may be charged to obtain server software.

Note

- For more information about the server software, please consult each software company.
- When server software for the media server is installed on the PC, the data may be at risk of being accessed by other people. Please take care of the settings and connections under the network circumstances at the office, hotel or even at home when not using a router.

■ DLNA Remote Control

You can control the TV with the DLNA Certified equipment.

- To use this function, set [Network Link Settings]. ➔ (p. 62)
- "Windows 7" is the OS that has been tested for compatibility of this TV (as of January, 2011). For the operations, refer to the help functions of Windows 7.

Network connections ➔ "Example 1", "Example 2" (p. 61)

Network setup ➔ (p. 62 - 65)

DLNA operations ➔ (p. 66 - 69)

VIERA Connect

VIERA Connect is a gateway to the internet services unique to Panasonic.

VIERA Connect allows you to access some specific websites supported by Panasonic, and enjoy internet contents such as videos, games, communication tools, etc. from VIERA Connect home screen.

- This TV does not support full web browser function and some features of the websites may not be available.

Network connections ➔ "Example 1", "Example 3" (p. 61)

Network setup ➔ (p. 62 - 65)

VIERA Connect operations ➔ (p. 18, 69)

Network connections

To use only DLNA features, you can operate the features without broadband network environment.

To use VIERA Connect features, you need a broadband network environment.

- If you do not have any broadband network services, please consult your retailer for assistance.
- Set up and connect any equipment required for the network environment. You cannot make settings for the equipment on this TV. Read the manual of the equipment.
- Required speed (effective): at least 1.5 Mbps for SD and 6 Mbps for HD picture quality, respectively. If the transfer speed is not enough, contents may not be played back properly.

Example 1

(For DLNA and VIERA Connect)

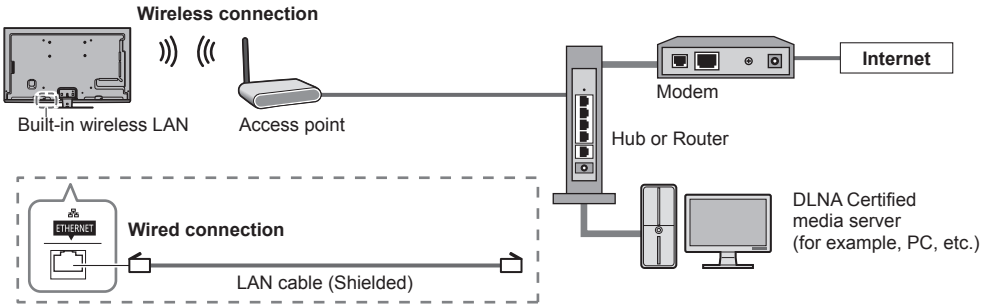

- Ensure to use a LAN straight cable for this connection.
- If your modem has no broadband router functions, use a broadband router.
- If your modem has broadband router functions but there are no vacant ports, use a hub.
- Ensure that the broadband routers and hubs are compatible with 10BASE-T / 100BASE-TX.
- If you use the equipment compatible only with 100BASE-TX, category 5 LAN cables are required.

Example 2

(For DLNA)

You can connect the TV and the equipment directly to use DLNA features.



- Ensure to use a LAN cross cable for this connection.

Example 3

(For VIERA Connect)

You can connect the TV and the telecommunication equipment directly to use VIERA Connect features.

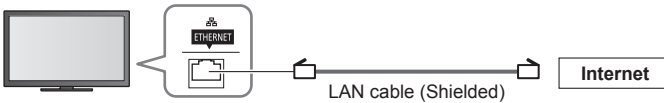

Note

- Contact your Internet Service Provider (ISP) telecommunications company for further assistance regarding the network equipment.
- Confirm the terms and conditions of the contracts with your Internet Service Provider (ISP) or telecommunications company. Depending on the contracts, additional fees may be charged or multiple connections to the internet may be impossible.

Network Setup

- Ensure the connections are completed before starting Network Setup.
 - ➔ “Network connections” (p. 61)

Display the menu and select [Network]



Network Link Settings

Sets the link settings to control this TV from the network equipment via the network.

1 Select [Network Link Settings]

Connection Test	
Network Connection	Wired
Wireless Network Settings	
IP/DNS Settings	
Network Link Settings	Access
Software Update	
New Software Message	On
Network Status	



2 Select the items and set

Network Link Settings	
VIERA Name	VIERA
DLNA Remote Control	On
DLNA Remote Volume	On
Network Remote Control	On



Using Network Services (DLNA / VIERA Connect)

Menu	Item	Adjustments / Configurations (alternatives)
Network Link Settings	VIERA Name	Sets your favourite name for this TV <ul style="list-style-type: none"> • This name will be used as the name of this TV on the screen of the other network equipment.
	DLNA Remote Control	Enables to control the TV using Windows 7 via the network [Off] / [On]
	DLNA Remote Volume	Enables to control the volume of the TV using Windows 7 via the network [Off] / [On]
	Network Remote Control	Enables to control the TV from the network equipment (smartphone, etc.) [Off] / [On] <ul style="list-style-type: none"> • Depending on the area, this function may not be available. For details, consult your local Panasonic dealer. • For more information of this function (English only): http://panasonic.jp/support/global/cs/tv/

Wired connection settings

This setting is for the network connection by using the LAN cable.

1 Select [Network Connection] and set to [Wired]

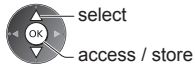
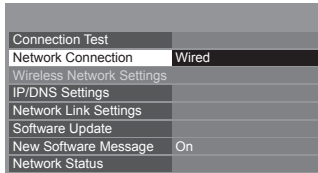

If you make the network connection like "Example 2" (p. 61), you do not have to set [Acquire DNS Address], [Proxy] and [Proxy Port].

2 Select [IP/DNS Settings] and set the items



■ [Acquire IP Address] / [Acquire DNS Address]

Sets [IP Address], [Subnet Mask], [Default Gateway] and [DNS Address]. Select [Acquire IP Address] / [Acquire DNS Address] and set to [Auto] (recommended).

- The available settings are displayed automatically.

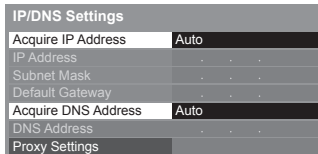

Manual settings
([IP Address], [Subnet Mask], [Default Gateway], [DNS Address])



3 Select [Proxy Settings] and set the items

It is not required for normal household use.

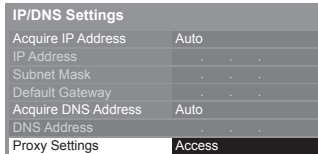

- After settings, return to the previous menu.



■ [Proxy]

Sets Proxy address.

- This is the address of the relay server that is connected to the target server instead of the browser and sends data to the browser. Setting is required if specified by the provider.

1. Select [Proxy]



2. Enter the address



- You can set characters by using numeric buttons. (English only) ➔ (p. 87)

3. Store



■ [Proxy Port]

Sets Proxy port number.

- This number is also specified by the provider with the Proxy address.

1. Select [Proxy Port]



2. Move the cursor and enter the number



4 Select [Connection Test] and access to test



- Performs automatic testing of the network connection for the TV. (It takes a while to test.)

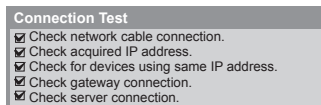

- : **succeeded**
The test is successful and the TV is connected to the network.
- : **failed**
Check the settings and connections. And then try again.

Using Network Services (DLNA / VIERA Connect)

Wireless connection settings

This setting is for the wireless network connection.

- Confirm the encryption key, settings and positions of your access point before starting setup. For details, read the manual of the access point.

1 Select [Network Connection] and set to [Wireless]

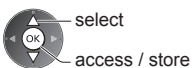
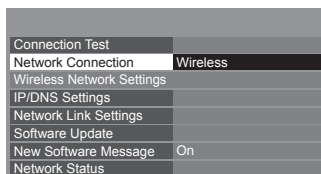

2 Select [Wireless Network Settings]

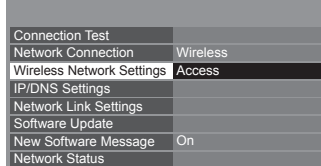

- When the access point is already set, [Current Settings] screen will be displayed.
To change the settings, select [No] on this screen and go to the next step.

3 Select your desired access point

Available Wireless Networks			
No.	Network Name (SSID)	Wireless type	Status
1	Access Point A	11n(2.4GHz)	<input type="checkbox"/> []
2	Access Point B	11n(5GHz)	<input checked="" type="checkbox"/> []
3	Access Point C	11n(5GHz)	<input type="checkbox"/> []



- For the information of the highlighted access point

: Encrypted access point

- To search access points again



- To set [WPS(Push button)] → (p. 17)



- To set manually → (p. 65)



- To set [WPS(PIN)] → (p. 65)



4 Access the encryption key input mode (English only)

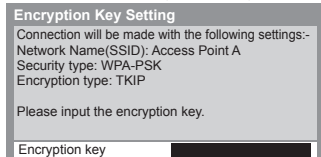

- If the selected access point is not encrypted, the confirmation screen will be displayed. It is recommended to select the encrypted access point.

5 Enter the encryption key of the access point

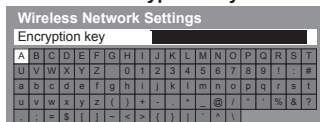

Set characters

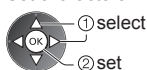

- You can set characters by using numeric buttons. (English only)
➔ (p. 87)
- After settings, return to the previous menu.



6 Select [Connection Test] and access to test



Performs automatic testing of the network connection for the TV. (It takes a while to test.)

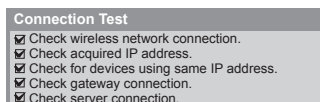

: **succeeded**

The test is successful and the TV is connected to the network.

: **failed**

Check the settings and connections. And then try again.

If you continue to have difficulty, please contact your internet service provider.

■ [WPS(PIN)]

Enter the PIN code to the access point, and then select [Connect]

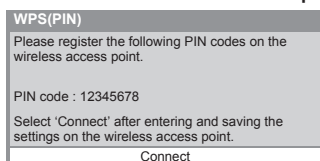

■ [Manual]

You can setup SSID, security type, encryption type, and encryption key manually. Follow the on-screen instructions and set manually.

- When you use 11n (5 GHz) for the wireless system between the built-in wireless LAN and access point, select [AES] for the encryption type.

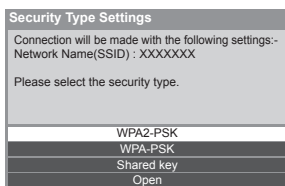
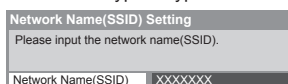

Update TV's software

Accesses the specific website to update TV's software and search if any software updates are available.

Select [Software Update]

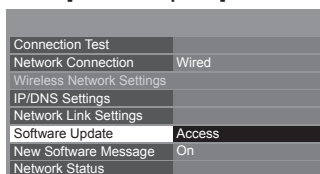

- Follow the on-screen instructions.

Using DLNA® features

- Ensure the preparation of the media server, network connections and network settings are completed.
➔ (p. 60 - 65)

1 Display [VIERA TOOLS] and select [Media Server]



2 Select one of the media servers to access

Example: Media server list

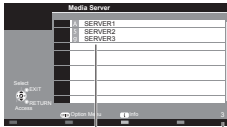

Available media servers
Total listed number



- To display the information of the highlighted media server



3 Select the file

Example: File list

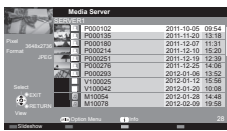

- Depending on the condition of media server, you may need to select the folder before selecting the file.

- To display the information of the highlighted file



Note

- Non-playable files are also listed but cannot be selected.
- Turn the TV off, and then on again when changing or reconnecting the network connection.
- You can use the following buttons during playback.
Confirm the code of the remote control to "73" ➔ (p. 26)



For photo file

[Single view] - Photos are displayed one at a time.

Example:



Operation guide

- To display / hide the operation guide



- To operate Single view
 - To the previous photo
 - Slideshow
 - To the next photo
 - Stop (return to list)



- To return to list



- To rotate 90°



[Slideshow] - Slideshow completes when all photos are viewed within the list.

1 Select the photo file from the list for the first view **2 Start Slideshow**



• To display / hide the operation guide



• To pause (return to Single view)



• To return to list



For video file

Playback - Playback will start.

If you stopped the last playback on the way, the confirmation screen is displayed to select whether to start from where you stopped last time or from the beginning.

Example: Playback



Operation guide

Information banner

• To display / hide the operation guide and information banner



• To the previous content



• To the next content



• To change aspect



• To operate the playback

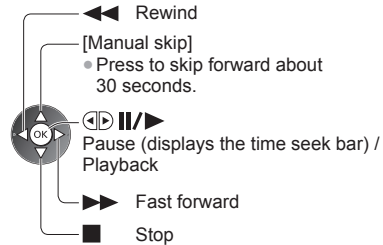

• To return to list



For music file

Playback - Playback will start.

Example: Playback

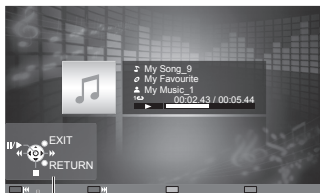

Operation guide

• To display / hide the operation guide



• To operate the playback



• To the previous track



• To the next track



• To return to list



Option menu for each content

Setup the settings for Photo, Video and Music file operations.

1 Display the option menu



2 Select [Slideshow Settings], [Video Setup] or [Music Setup]

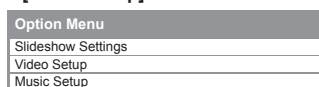

3 Select the items and set



Menu	Item	Adjustments / Configurations (alternatives)
Slideshow Settings	Transition Effect	Selects the transition effect for switching the photo during the slideshow [Off] / [Fade] / [Slide] / [Dissolve] / [Motion] / [Random] [Fade]: The next photo fades in gradually. [Slide]: The next photo slides and appears from the left side. [Dissolve]: Each photo is dissolved when switching to the next photo. [Motion]: Each photo is displayed with an effect of enlarging, reducing, moving up or moving down. [Random]: Each transition is selected at random.
	Interval	Selects slideshow interval [5] / [10] / [15] / [30] / [60] / [90] / [120] (seconds) • This function is not available when [Transition Effect] is set to [Motion].
	Repeat	Slideshow repeat [Off] / [On]
	Back Ground Music	Selects the back ground music during Photo mode [Off] / [Type1] / [Type2] / [Type3] / [Type4] / [Type5]
Video Setup	Video Preview	Sets to start the preview of the title or scene in the thumbnail screen [Off] / [On] • Image may not be displayed for an instant in the thumbnail screen. Set the preview [Off] to resolve this.
	Multi Audio, Dual Audio, Dual Mono Audio	Selects between selectable sound tracks (if available) • It may take several seconds to change the sound. • Only available during playback
	Subtitle	Subtitles On / Off (if available) • Only available during playback
	Subtitle Text	Selects the font type to display subtitles correctly (if available) • Only available during playback
	Aspect Change	[Aspect1]: Displays the content enlarged without distortion. [Aspect2]: Displays the content full-screen. [Original]: Displays the content original size. • You can also change the aspect using the ASPECT button. • Aspect change may not work depending on the content. • Only available during playback
	Repeat	Playback repeat within the selected file [Off] / [On]
Music Setup	Repeat	Playback repeat [Off] / [Folder] / [One] [Folder]: Playback repeat within the selected folder. [One]: Playback repeat of the selected one file.

Audio output settings (for video contents)

You can enjoy the multi-channel sound via an amplifier connected to DIGITAL AUDIO OUT or HDMI2 (ARC function) terminal.

- To confirm or change the current sound status ➔ (p. 58)

1 Display the menu and Select [Sound]

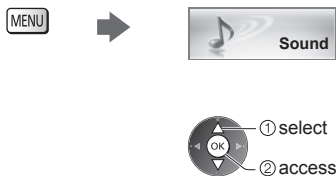

2 Select [SPDIF Selection] and set

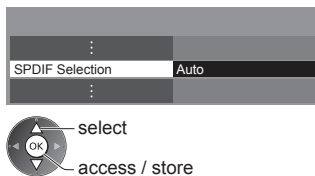

Menu	Item	Adjustments / Configurations (alternatives)
Sound	SPDIF Selection	<p>SPDIF: A standard audio transfer file format</p> <p>Selects the initial setting for digital audio output signal from DIGITAL AUDIO OUT and HDMI2 (ARC function) terminals [Auto] / [PCM]</p> <p>[Auto]: Dolby Digital Plus, Dolby Digital and HE-AAC multi-channel are output as Dolby Digital Bitstream. DTS is output as DTS. MPEG is output as PCM.</p> <p>[PCM]: Digital output signal is fixed to PCM.</p>

VIERA Connect

You can access VIERA Connect and enjoy various network contents.

- VIERA Connect requires a broadband internet connection. Dial-up internet connections cannot be used.
- Ensure the network connections and network settings are completed.
 - ➔ “Network connections” (p. 61), [Network Setup] (p. 62 - 65)
- For details about VIERA Connect operation ➔ (p. 18)
- Setup menu (Items in [Setup] may change without notice.)

Customize HomeScreen	Changes the position of each services on VIERA Connect home screen
My Account	Confirms or removes the account information of the TV you entered on VIERA Connect
Lock	Sets to restrict access to some services
Beep	Sets beep sound On or Off when operating VIERA Connect
Notices	Displays the information of VIERA Connect

Note

- Be sure to update the software when a software update notice is displayed on the TV screen. If the software is not updated, you will not be able to use VIERA Connect. You can update the software later manually. ➔ [Software Update] in [Network] (p. 65)
- VIERA Connect home screen is subject to change without notice.
- The services through VIERA Connect are operated by their respective service providers, and service may be discontinued either temporarily or permanently without notice. Therefore, Panasonic will make no warranty for the content or the continuity of the services.
- Some content may be inappropriate for some viewers.
- Some content may only be available for specific countries and may be presented in specific languages.
- Depending on the connection environment, the internet connection may be slow or may not be successful.
- During the operation, audio signal is output from AUDIO OUT, DIGITAL AUDIO OUT and HDMI2 (ARC function) terminals. To use HDMI2 with ARC function, connect an amplifier that has ARC function (p. 71) and set to use theatre speakers (p. 76).
- You can restrict access to VIERA Connect. ➔ [Child Lock] (p. 46)
- Turn the TV off, and then on again when changing or reconnecting the network connection.

Link Functions (VIERA Link)

VIERA Link (HDAVI Control™) connects the TV and the equipment with VIERA Link function, and enables easy control, convenient recording, playback, energy saving, creating home theatre, etc., without complicated setting.

➔ (p. 72 - 76)

- This TV supports "HDAVI Control 5" function. But available features are depending on the connected equipment's version of HDAVI Control. Please read the manual of the equipment to confirm the version.
- VIERA Link features may be available even with other manufacturers' equipment supporting HDMI CEC.

Summary of features

VIERA Link (HDMI connection)

Connected equipment	DIGA Recorder	DVD Player / Blu-ray Disc Player	HD Video Camera / LUMIX Camera
Channel download	○*2	—	—
Easy playback	○	○	○
Power on link	○	○	○
Power off link	○	○	○
Reduce unnecessary power consumption in Standby	○*3	○*3	—
Auto standby for unnecessary equipment	○*3	○*3	—
Pause Live TV programme	○*2 *4	—	—
Direct TV Recording	○*2	—	—
Control the menu of the connected equipment by VIERA remote control	○*1	○*1	○*1
Speaker control	—	—	—

Link Functions (VIERA Link)

Connection

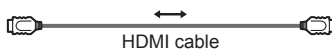

HDMI cable

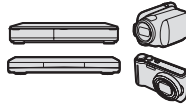

DIGA Recorder / DVD Player / Blu-ray Disc Player / HD Video Camera / LUMIX Camera with VIERA Link function

- Use fully wired HDMI compliant cable.
- Connect the equipment supporting VIERA Link to the TV's HDMI terminal via an HDMI cable.
- About HDMI cable for connecting Panasonic HD Video Camera or LUMIX Camera, read the manual of the equipment.

VIERA Link (HDMI and Audio out connections)

Features	Connected equipment	Player theatre	Blu-ray Disc theatre	Amplifier
Channel download		—	—	—
Easy playback		○*5	○*5	—
Power on link		○	○	—
Power off link		○	○	○
Reduce unnecessary power consumption in Standby		—	○*3	—
Auto standby for unnecessary equipment		○*3 *6	○*3 *6	○*3
Pause Live TV programme		—	—	—
Direct TV Recording		—	—	—
Control the menu of the connected equipment by VIERA remote control		○*1	○*1	—
Speaker control		○	○	○

Connection

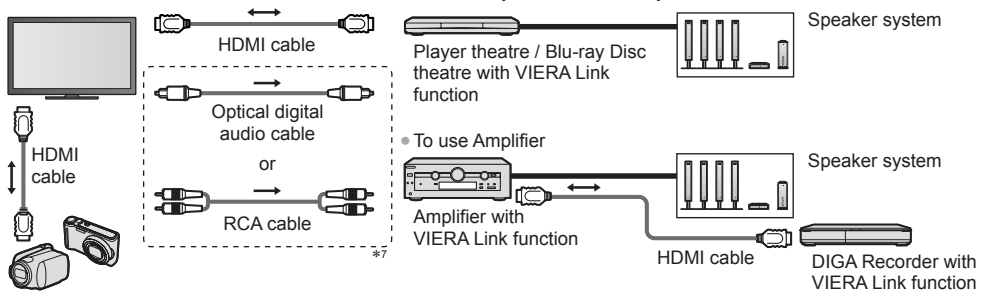

HD Video Camera / LUMIX Camera with VIERA Link function

- Use fully wired HDMI compliant cable.
- Connect the equipment supporting VIERA Link to the TV's HDMI terminal via an HDMI cable.
- Use the optical digital audio cable, or RCA cable for audio output from the TV.

- *1: Available with the equipment which has "HDAVI Control 2 or later" function.
- *2: Available with the equipment which has "HDAVI Control 3 or later" function.
- *3: Available with the equipment which has "HDAVI Control 4 or later" function.
- *4: Available with a DIGA Recorder which has HDD.

*5: While playing a disc.

*6: Except for watching a disc.

*7: If the connected equipment has "HDAVI Control 5" function, you do not have to use this audio cable (Optical digital audio cable or RCA cable). In this case, connect the equipment to the TV's HDMI2 terminal via an HDMI cable.

VIERA Link Control of compatible equipment → [VIERA Link Control] (p. 74)

- Table below displays maximum number of compatible equipment that can be controlled by VIERA Link Control. This includes connections to equipment already connected to the TV. For example, DIGA Recorder connected to Amplifier which is connected to the TV via an HDMI cable.

Type of the equipment	Maximum number
Recorder (DIGA Recorder, etc.)	3
Player (DVD Player, Blu-ray Disc Player, HD Video Camera, LUMIX Camera, Digital Camera, Player theatre, Blu-ray Disc theatre, etc.)	3
Audio system (Player theatre, Blu-ray Disc theatre, Amplifier, etc.)	1
Tuner (Set top box, etc.)	4

VIERA Link “HDAVI Control”TM※

***Enjoy additional HDMI Inter-Operability with Panasonic products which have “HDAVI Control” function.**

This TV supports “HDAVI Control 5” function.

These features are limited to models incorporating “HDAVI Control” and “VIERA Link”.

- Some functions are not available depending on the equipment’s version of HDAVI Control. Confirm the connected equipment’s version of HDAVI Control.
- VIERA Link “HDAVI Control”, based on the control functions provided by HDMI which is an industry standard known as HDMI CEC (Consumer Electronics Control), is a unique function that we have developed and added. As such, its operation with other manufacturers’ equipment that supports HDMI CEC cannot be guaranteed.
- Please refer to individual manuals for other manufacturers’ equipment supporting VIERA Link function.
- About applicable Panasonic equipment, consult your local Panasonic dealer.

Preparations

- Connect the equipment supporting VIERA Link.
 - VIERA Link connection ➔ (p. 70, 71)
 - Use fully wired HDMI compliant cable. Non-HDMI-compliant cables cannot be utilised.
Recommended Panasonic’s HDMI cable part number:
 - RP-CDHS15 (1.5 m) • RP-CDHS30 (3.0 m) • RP-CDHS50 (5.0 m)
 - Set up the connected equipment. Read the manual of the equipment.
 - For optimal recording, the settings of the recorder may need to be changed. For details, read the manual of the recorder.
 - Set [VIERA Link] to [On] in the Setup Menu. ➔ [VIERA Link] (p. 42)
 - Set up the TV.
- After connection, turn the equipment on and then switch the TV on.
Select the input mode from HDMI1, HDMI2, HDMI3 or HDMI4 (p. 25), and make sure that an image is displayed correctly.**
- This setup should be done each time when the following conditions occur:
 - for the first time
 - when adding or reconnecting equipment
 - when changing setup

Link Functions (VIERA Link)

Features available

Channel download

Channel settings can be downloaded to the recorder.

Easy playback

Automatic input switching - When the connected equipment is operated, input mode is switched automatically.

Power on link

Set Power on Link [On] in the Setup Menu to use this function ➔ [Power on Link] (p. 42)

When the connected equipment starts playback or direct navigator / function menu for the equipment are activated, the TV is automatically turned on. (Only when the TV is in Standby mode.)

Power off link

Set Power off Link [On] in the Setup Menu to use this function ➔ [Power off Link] (p. 42)

When the TV is set to Standby mode, the connected equipment is also automatically set to Standby.

- This function will work even if the TV enters Standby mode automatically by auto power standby function.

Reduce unnecessary power consumption in Standby [Standby Power Save]

Set Standby Power Save [On] in the Setup Menu to use this function ➔ [Standby Power Save] (p. 42)

The power consumption in Standby mode of the connected equipment is controlled higher or lower in synchronisation with the TV On / Off state to reduce the consumption.

When the TV is set to Standby mode, the connected equipment is automatically set to Standby and the power consumption of the connected equipment is automatically minimised.

When the TV is turned on, the connected equipment is still in Standby mode, but the power consumption is increased to make startup time fast.

- This function is effective if the connected equipment can change the power consumption in Standby mode and is set to higher consumption.
- This function works when [Power off Link] is set to [On].

Auto standby for unnecessary equipment [Intelligent Auto Standby]

Set Intelligent Auto Standby [On (With reminder)] or [On (No reminder)] in the Setup Menu to use this function ➔ [Intelligent Auto Standby] (p. 42)

When the TV is on, non-watched or non-used connected equipment goes into Standby mode automatically to reduce the power consumption. For example, when the input mode is switched from HDMI or when Speaker Selection is changed to [TV] (except for watching a disc).

- If you select [On (With reminder)], the on-screen message will be displayed before the connected equipment turns to standby.
- This function may not work properly depending on the connected equipment. If required, set to [Off].

Direct TV Recording - What you see is What you record [Direct TV Rec]

Records the current programme in the DIGA Recorder immediately.

- If you connect a variety of recorders including other manufacturers' recorders at the same time, connect the DIGA Recorder to the TV's lower HDMI terminal number. For example, if you use HDMI1 and HDMI2 for two recorders, connect the DIGA Recorder to HDMI1.

- If you cannot operate, check the settings and the equipment.
➔ "Summary of features" (p. 70, 71), "Preparations" (p. 72)

1 Display [VIERA TOOLS] and select [VIERA Link]



2 Select [Direct TV Rec] and start recording



■ To stop recording

Select [Stop] in [Direct TV Rec]

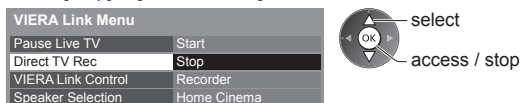

Pause Live TV programme [Pause Live TV]

You can pause the current TV programme and resume later.

The current TV programme will be recorded on HDD of the connected DIGA Recorder.

- This function is available with the DIGA Recorder which has HDD.
- If you connect a variety of recorders including other manufacturers' recorders at the same time, connect the DIGA Recorder which has an HDD to the TV's lower HDMI terminal number. For example, if you use HDMI1 and HDMI2 for two recorders, connect the DIGA Recorder which has HDD to HDMI1.
- If you cannot operate, check the settings and the equipment.
 - ➔ "Summary of features" (p. 70, 71), "Preparations" (p. 72)

1 Display [VIERA TOOLS] and select [VIERA Link]



2 Select [Pause Live TV] and pause

The TV picture will be paused.

VIERA Link Menu	
Pause Live TV	Start
Direct TV Rec	Start
VIERA Link Control	Recorder
Speaker Selection	Home Cinema

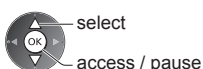

- The current TV programme is recorded on HDD from where it was paused.
- If the paused TV picture disappears after a few minutes, press OPTION button to restore the pause picture.
- Follow the operation guide to operate [Pause Live TV] function.

Link Functions (VIERA Link)

■ To operate [Pause Live TV]

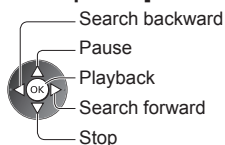

- If you stop playback, the recorded programme will be deleted from HDD.

- Operations may vary depending on the recorder. In this case, follow the operation guide or read the manual of the recorder.

■ To return to current TV (Stop playback of [Pause Live TV] / cancel pause)

Select [Yes]

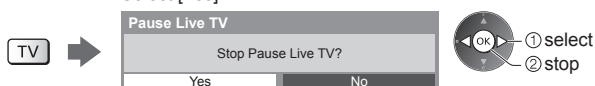

- If you stop playback or cancel pause, the recorded programme will be deleted from HDD.

Control the menu of the connected equipment by VIERA remote control [VIERA Link Control]

You can control some functions of the connected equipment with this TV remote control pointing at the TV's signal receiver.

- If you cannot operate, check the settings and the equipment.
 - ➔ "Summary of features" (p. 70, 71), "Preparations" (p. 72)
- For details of the operations for the connected equipment, read the manual of the equipment.

1 Display [VIERA TOOLS] and select [VIERA Link]



2 Select [VIERA Link Control]

VIERA Link Menu	
Pause Live TV	Start
Direct TV Rec	Start
VIERA Link Control	Recorder
Speaker Selection	Home Cinema



3 Select the equipment to access

Select the type of the connected equipment and access.

VIERA Link Menu	
Pause Live TV	Start
Direct TV Rec	Start
VIERA Link Control	Recorder
Speaker Selection	Home Cinema



[Recorder] / [Player] / [Home Cinema] / [Video Camera] / [LUMIX] / [Digital Camera] / [Other]

- The displayed item may vary depending on the connected equipment.
- [Home Cinema] means Player theatre, Blu-ray Disc theatre or Recorder theatre.
- [Other] means Tuner set top box.

The menu of the accessed equipment will be displayed.
(Input mode will be changed automatically)

4 Operate the menu of the equipment

1 Confirm the code of the remote control to "73" ➔ (p. 26)

2 Follow the operation guide

- To display the operation guide

OPTION



If other manufacturers' equipment is accessed, Setup / Contents Selection menu may be displayed.

- Available VIERA remote control buttons depend on the connected equipment.

Note

- Some operations may not be available depending on the equipment. In this case use its own remote control to operate the equipment.

■ If multiple recorders or players are connected

VIERA Link Menu	
Pause Live TV	Start
Direct TV Rec	Start
VIERA Link Control	Recorder2
Speaker Selection	Home Cinema

[Recorder1-3 / Player1-3]

The number is given from the TV's lower number of HDMI terminal connected to the same type equipment. For example, two recorders to HDMI2 and HDMI3, the recorder connected to HDMI2 is displayed as [Recorder1], and the recorder connected to HDMI3 is displayed as [Recorder2].

■ If you access non-VIERA Link equipment

VIERA Link Menu	
Pause Live TV	Start
Direct TV Rec	Start
VIERA Link Control	Recorder
Speaker Selection	Home Cinema

The type of the connected equipment is displayed. Although you can access the connected equipment, you cannot operate it. Use its own remote control to operate the equipment.

Speaker control [Speaker Selection]

You can control the theatre speaker with this TV remote control pointing at the TV's signal receiver.

- If you cannot operate, check the settings and the equipment.
➔ "Summary of features" (p. 70, 71), "Preparations" (p. 72)

1 Display [VIERA TOOLS] and select [VIERA Link]



2 Select [Speaker Selection]

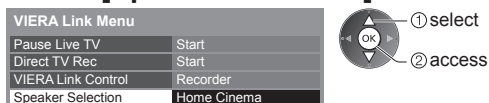

3 Set to [Home Cinema] or [TV]

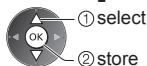

[Home Cinema]:

The sound is from theatre speakers. Player theatre, Blu-ray Disc theatre or Amplifier will be automatically turned on if it is in Standby mode.

- Volume up / down



- Mute



- The sound of TV speakers is mute.
- When the equipment is turned off, TV speakers will be active.

[TV]:

TV speakers are active.

Multi-channel sound

If you want to enjoy the multi-channel sound (e.g. Dolby Digital 5.1ch) via an Amplifier, connect it with HDMI cable and Optical digital audio cable (p. 71), and then select [Home Cinema]. If your Amplifier has "HDAVI Control 5" function, you only need to connect it with HDMI cable to the TV's HDMI2 terminal.

To enjoy the sound from the DIGA Recorder in multi-channel sound, connect an HDMI cable from the DIGA Recorder to the Amplifier (p. 71).

Note

- These functions may not work properly depending on the connected equipment.
- Image or sound may not be available for the first few seconds when input mode is switched.
- "HDAVI Control 5" is the newest standard (as of November, 2011) for HDAVI Control compatible equipment. This standard is compatible with conventional HDAVI equipment.
- To confirm this TV's version of HDAVI Control ➔ [System Information] (p. 42)

External Equipment

These diagrams show our recommendations for connection of your TV to various pieces of equipment. For other connections, consult the instructions for each piece of equipment, the basic connection (p. 12 - 14), the table (p. 79), and the specifications (p. 92 - 94).

- Check the type of terminals and cable plugs are correct when connecting.

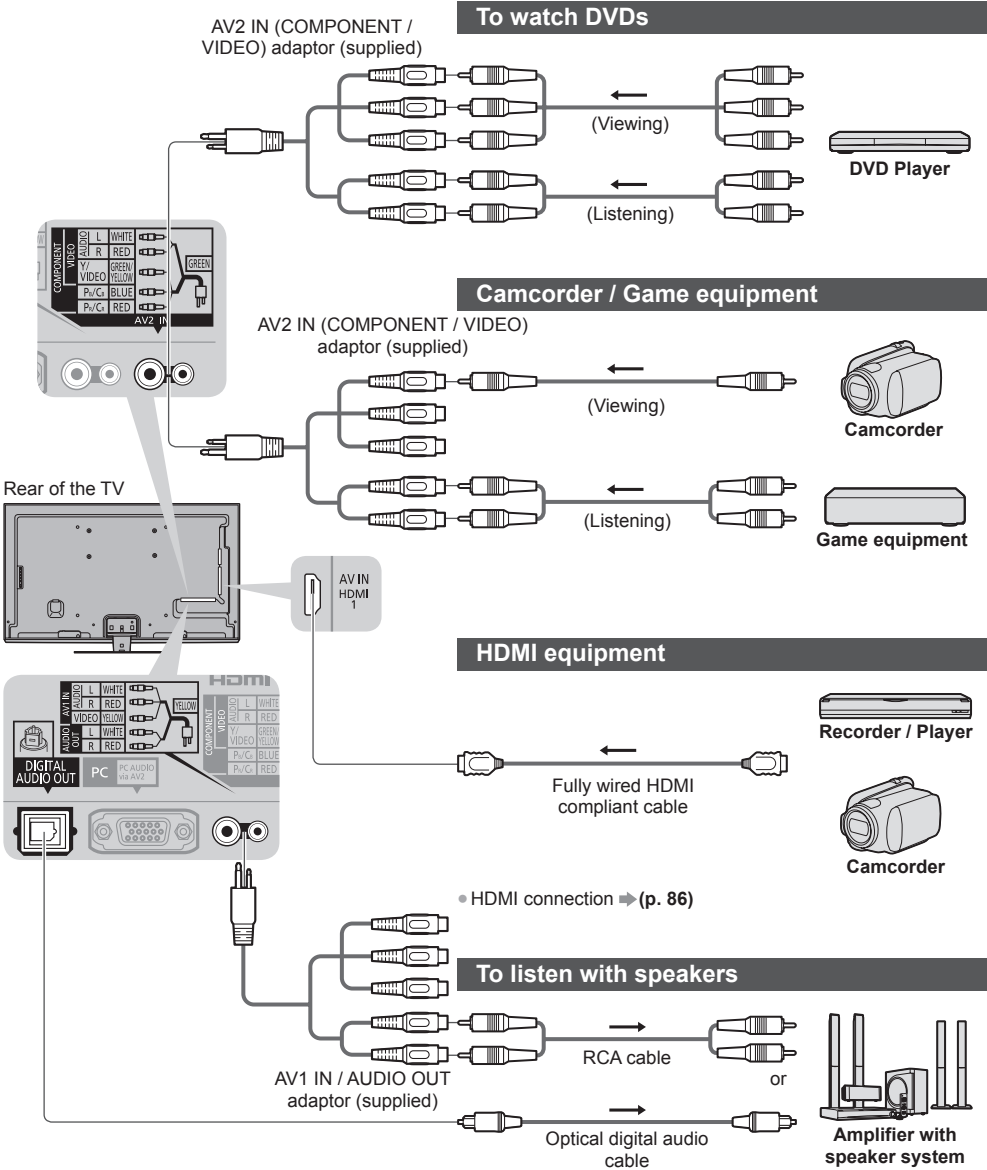

External Equipment

To enjoy the sound from the external equipment in multi-channel sound (e.g. Dolby Digital 5.1ch), connect the equipment to the amplifier. For the connections, read the manuals of the equipment and amplifier.

Rear of the TV

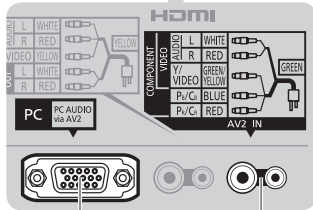
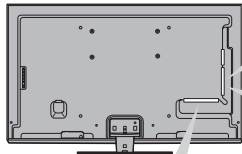

Headphones



(M3 stereo mini plug)

- To adjust volume
➔ **[Headphone Volume]** (p. 39)

USB devices



Communication Camera

AV2 IN (COMPONENT / VIDEO) adaptor (supplied)

PC

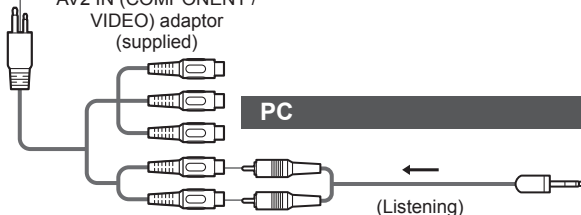

(Listening)

(Viewing)









Conversion adaptor (if necessary)



Computer

External Equipment

Types of connectable equipment to each terminal

Features	Terminal							
	AV1 IN*1	AUDIO OUT*1	AV2 IN*1		DIGITAL AUDIO OUT	ETHERNET	HDMI 1 - 4	USB 1 - 3
			COMPONENT	VIDEO				
								
To watch 3D contents (Blu-ray Disc Player)							<input type="radio"/>	
To watch satellite broadcasts (Set top box)	<input type="radio"/>			<input type="radio"/>			<input type="radio"/>	
To watch videocassettes / DVDs (VCR / DVD player)	<input type="radio"/>		<input type="radio"/>	<input type="radio"/>			<input type="radio"/>	
To watch camcorder images (Video camera)	<input type="radio"/>			<input type="radio"/>			<input type="radio"/>	
To play games (Game equipment)	<input type="radio"/>			<input type="radio"/>			<input type="radio"/>	
To use amplifier with speaker system		<input type="radio"/>			<input type="radio"/>		<input type="radio"/> *2	
To use network services						<input type="radio"/>		<input type="radio"/> *3
VIERA Link							<input type="radio"/>	

External Equipment

○: Recommended Connection

*1: To connect the equipment, the terminal adaptor (supplied) is necessary.

*2: Use HDMI2 for connecting an amplifier. This connection is applicable when using an amplifier that has ARC (Audio Return Channel) function.

*3: Use USB 2 port for connecting the Communication Camera.

Technical Information

Channel Allocation

Channel Plan	Asia / W.Europe	CIS / E.Europe	China	Hong Kong	NZ / Indonesia	Indian CATV	South Africa	American System	American CATV	Japan CATV
CH DISPLAY	Receive channel									
0	-	-	-	-	-	-	-	-	-	-
1	-	1	1	-	1	1	1	-	1	1
2	2	2	2	-	2	2	2	2	2	2
3	~	~	~	-	~	3	~	~	~	~
4	~	~	~	-	~	4	~	~	~	~
5	~	~	~	-	~	S'1	~	~	~	~
6	~	~	~	-	~	S'2	~	~	~	~
7	~	~	~	-	~	S'3	~	~	~	~
~	~	~	~	-	~	S1	~	~	~	~
11	11	11	-	-	11	S2	11	~	~	~
12	12	12	12	-	-	S3	12	~	~	12
13	-	-	13	-	-	S4	13	13	~	13
14	-	-	-	-	-	-	-	14	~	~
15	-	-	~	-	-	~	-	~	~	~
16	-	-	-	-	-	~	-	~	~	~
19	-	-	-	-	-	~	-	~	~	~
~	-	-	-	-	-	S10	-	~	~	~
20	-	-	~	-	-	5	-	~	~	~
21	21	21	~	21	21	6	21	~	~	~
22	~	~	~	~	~	~	~	~	~	~
23	~	~	~	~	~	~	~	~	~	~
24	~	~	~	~	~	12	~	~	~	~
~	~	~	~	~	~	S11	~	~	~	~
28	~	~	~	~	~	~	~	~	~	~
~	~	~	~	~	~	S40	~	~	~	~
57	~	~	57	~	~	S41	~	~	~	~
58	~	~	-	~	~	21	~	~	~	~
59	~	~	-	~	~	~	~	~	~	~
62	62	62	-	62	62	24	62	62	62	62
63	63	63	-	63	63	25	63	63	63	63
~	~	~	-	~	~	~	~	~	~	~
69	69	69	-	69	69	31	69	69	~	~
70	-	-	-	-	-	32	-	-	~	~
~	~	~	~	~	~	~	~	~	~	~
73	-	-	-	-	-	~	-	-	~	~
74	S'1	S'1	-	S'1	S'1	~	S'1	-	~	~
75	S'2	-	-	S'2	S'2	~	S'2	-	~	~
76	S'3	-	-	S'3	S'3	~	S'3	-	~	~
77	-	-	-	-	-	~	-	-	~	~
78	-	-	-	-	-	~	-	-	~	~
79	-	-	-	-	-	41	-	-	~	~
80	S1	S1	-	S1	S1	42	S1	-	~	~
81	S2	S2	Z1	S2	S2	~	S2	-	~	~
~	~	~	~	~	~	~	~	-	~	~
89	S10	S10	Z9	S10	S10	51	S10	-	~	~
90	S11	S11	Z10	S11	S11	52	-	-	~	~
91	S12	S12	Z11	S12	S12	~	-	-	~	~
92	S13	S13	Z12	S13	S13	~	-	-	~	~
93	S14	S14	Z13	S14	S14	~	S14	-	~	~
94	S15	S15	Z14	S15	S15	~	S15	-	~	~
95	S16	S16	Z15	S16	S16	~	S16	-	~	~
96	S17	S17	Z16	S17	S17	~	S17	-	~	~
97	S18	S18	Z17	S18	S18	~	S18	-	~	~
98	S19	S19	Z18	S19	S19	~	S19	-	~	~
99	S20	S20	Z19	S20	S20	61	S20	-	99	C49
100	S21	S21	Z20	S21	S21	62	S21	-	100	-
~	~	~	~	~	~	~	~	-	~	~
107	~	~	~	~	~	69	~	-	~	~
~	~	~	~	~	~	70	~	-	~	~
117	~	~	Z37	~	~	-	~	-	~	~
118	~	~	-	~	~	-	~	-	~	~
~	~	~	~	~	~	~	~	-	~	~
120	S41	S41	-	S41	S41	-	S41	-	~	~
~	~	~	-	~	~	-	~	-	~	~
125	-	-	-	-	-	-	-	-	125	-

Technical Information

Stereo / Bilingual Sound Selection



When you receive the stereo / bilingual sound system, sound output modes can be selected by pressing the Sound Selection button.

Audio Signal	STEREO	MAIN I	SUB II	MONO
Mode Indicator	⊕	I	II	▽

NICAMUsed in New Zealand, Singapore, Hong Kong etc.

Type of broadcast	Regular broadcast (Standard Audio)	Regular + NICAM MONO I (MAIN I)	NICAM STEREO	NICAM DUAL MONO (MAIN I / SUB II)
Mode Indicator	No Indicator ↔ ▽	I ↔ ▽	⊕ ↔ ▽	I → II ↙ ▽ ↘

A2 (German)Used in Australia, Malaysia etc.

Type of broadcast	Regular broadcast (Standard Audio)	BILINGUAL or DUAL MONO: MAIN I / SUB II	STEREO
Mode Indicator	No Indicator ↔ ▽	I ↔ II	⊕ ↔ ▽

- If the stereo signal is poor or the receiving conditions are not optimum or if STEREO:MONO automatic switching occurs, it is recommended you switch from STEREO to MONO.
- Even when the contents of the receiving signal undergo changes, selection mode is kept intact.
- When the receiving conditions deteriorate, listening will be easier if the mode is set to the MONO position, using the Sound Selection button.
- DUAL, also known as DUAL MONO or as BILINGUAL is not currently transmitted in some countries.

Supported file format in Media Player and media servers

■ Photo

Format	File extension	Image resolution (pixel)	Details / Restrictions
JPEG	.jpg .jpeg .mpo	8 × 8 to 30,719 × 17,279	DCF and EXIF standards Sub-sampling: 4:4:4, 4:2:2, 4:2:0 • Progressive JPEG is not supported.

■ Video

Container	File extension	Video codec	Audio codec	Details / Restrictions
AVCHD	.mts	H.264	Dolby Digital	AVCHD Standard Ver. 2.0 (AVCHD 3D, AVCHD Progressive) • The data may not be available if a folder structure on the device is modified.
SD-Video	.mod	MPEG1 MPEG2	Dolby Digital MPEG Audio	SD-Video Standard Ver. 1.31 (Entertainment Video Profile) • The data may not be available if a folder structure on the device is modified.
MOV	.mov .qt	DivX3 DivX4 DivX5 DivX6 H.264 BP/MP/HP Motion JPEG MPEG1 MPEG2 MPEG4 SP/ASP	AAC Dolby Digital Dolby Digital Plus DTS core HE-AAC LPCM MPEG Audio MP3	• This TV supports Motion JPEG recorded by Panasonic LUMIX Camera*1. • This TV is not available for playing back Motion JPEG with the media server. *1: Some products of before the year 2004 may not be available. The compatibility with future products is not guaranteed.
AVI	.avi .divx	DivX3 DivX4 DivX5 DivX6 H.264 BP/MP/HP MPEG1 MPEG2 MPEG4 SP/ASP VC-1 Windows Media Video Ver. 9	AAC ADPCM Dolby Digital Dolby Digital Plus DTS core HE-AAC LPCM MPEG Audio MP3 WMA	• Certified to play DivX Plus HD video file in Media Player For details of DivX ➔ (p. 84) • Some subtitles or chapter functions may not be available. • WMA Pro and WMA Lossless are not supported.
MKV	.mkv	DivX3 DivX4 DivX5 DivX6 H.264 BP/MP/HP MPEG1 MPEG2 MPEG4 SP/ASP	AAC Dolby Digital Dolby Digital Plus DTS core HE-AAC MPEG Audio MP3	

Container	File extension	Video codec	Audio codec	Details / Restrictions
ASF	.asf .wmv	DivX3 DivX4 DivX5 DivX6 MPEG4 SP/ASP VC-1 Windows Media Video Ver. 9	AAC Dolby Digital Dolby Digital Plus HE-AAC LPCM MP3 WMA	<ul style="list-style-type: none"> • Copy-protected files cannot be played back. • WMA Pro and WMA Lossless are not supported.
MP4	.f4v .m4v .mp4	DivX3 DivX4 DivX5 DivX6 H.264 BP/MP/HP MPEG1 MPEG2 MPEG4 SP/ASP	AAC Dolby Digital Dolby Digital Plus HE-AAC MPEG Audio MP3	<ul style="list-style-type: none"> • This TV supports this container recorded by Panasonic products. For details, read the manual of the products.
FLV	.flv	H.264	AAC MP3	–
3GPP	.3gp .3g2	H.264 MPEG4 SP/ASP	AAC HE-AAC	–
PS	.mpg .mpeg .vob .vro	H.264*2 MPEG1 MPEG2 VC-1*2	AAC*2 Dolby Digital Dolby Digital Plus*2 HE-AAC*2 LPCM MPEG Audio MP3*2	*2: This codec can be played back only in Media Player.
TS	.m2ts .tp .trp .ts	H.264 MPEG1 MPEG2 VC-1*3	AAC Dolby Digital Dolby Digital Plus DTS core*3 HE-AAC MPEG Audio MP3*3	*3: This codec can be played back only in Media Player.

■ Music

Codec	File extension	Restrictions
MP3	.mp3	–
AAC	.m4a	<ul style="list-style-type: none"> • Copy-protected files cannot be played back.
WMA	.wma	<ul style="list-style-type: none"> • Copy-protected files cannot be played back. • WMA Pro and WMA Lossless are not supported.
FLAC	.flac	–

Note

- Some files may not be played back even if they fulfil these conditions.
- Do not use two-byte characters or other special codes for data.
- The device may become unusable with this TV if the file or folder names are changed.

DivX

DivX Certified® to play DivX® and DivX Plus® HD (H.264/MKV) video up to 1080p HD including premium content.
ABOUT DIVX VIDEO:

DivX® is a digital video format created by DivX, LLC, a subsidiary of Rovi Corporation. This is an official DivX Certified® device that plays DivX video. Visit divx.com for more information and software tools to convert your files into DivX videos.

■ Subtitle text file of DivX

Subtitles format - MicroDVD, SubRip, TMLPlayer

- The DivX video file and subtitles text file are inside the same folder, and the file names are the same except for the file extensions.
- If there are more than one subtitles text files inside the same folder, they are displayed in the following order of priority:
".srt", ".sub", ".txt".
- To confirm or change the current subtitle status while playing DivX content, press the OPTION button to display Option Menu.
- Depending on the methods used to create the file or the state of recording, only parts of the subtitles may be displayed, or the subtitles may not be displayed at all.
- Some subtitles text may not be displayed correctly.

Note

- Depending on how you make SD Card, USB Flash Memory or the media server, files and folders may not be displayed in the order you numbered.
- Depending on how you create the files and the structure of folders, the files and folders may not be displayed.
- When there are many files and folders, operation may take time to complete or some files may not be displayed or playable.

ABOUT DIVX VIDEO-ON-DEMAND:

This DivX Certified® device must be registered in order to play purchased DivX Video-on-Demand (VOD) movies. To obtain your registration code, locate the DivX VOD section in the Setup Menu. Go to vod.divx.com for more information on how to complete your registration.

■ To show DivX VOD registration code

➔ [DivX® VOD] (p. 42)

- If you want to generate the new registration code, you have to deregister the current registration code.
After playing DivX VOD content once, the confirmation screen to deregister will be displayed in [DivX® VOD] in the Setup Menu. If you press the OK button on the confirmation screen, the deregistration code will be generated and you will not be able to play any contents that you purchased using the current registration code.
You will obtain the new registration code by pressing the OK button on the deregistration code screen.
- If you purchase DivX VOD content using a registration code different from this TV's code, you will not be able to play this content. ([Your device is not authorized to play this DivX protected video.] is displayed.)

■ Regarding DivX content that can only be played a set number of times

Some DivX VOD content can only be played a set number of times.

When you play this content, the remaining number of plays is displayed. You cannot play this content when the number of remaining plays is zero. ([This DivX rental has expired.] is displayed.)

- When playing this content, the number of remaining plays is reduced by one in the following conditions:
 - If you exit the current application.
 - If you play the other content.
 - If you go to the next or previous content.

Devices for playing back

■ SD Card

Use an SD Card which meets SD standards. If not, it may cause the TV to malfunction.

Card format:

SDXC Card - exFAT

SDHC Card / SD Card - FAT16 or FAT32

Compliant card type (maximum capacity):

SDXC Card (64 GB), SDHC Card (32 GB), SD Card (2 GB), miniSD Card (2 GB) (requiring miniSD adaptor)

- If miniSD Card is used, insert / remove it together with the adaptor.
- Check the latest information on the card type at the following website. (English only)
<http://panasonic.jp/support/global/cs/tv/>

■ USB Flash Memory

USB Flash Memory format: FAT16, FAT32 or exFAT

Note

- Data modified with a PC may not be displayed.
- Do not remove the device while the TV is accessing data. Otherwise this can damage device or TV.
- Do not touch the pins on the device.
- Do not subject the device to a high pressure or impact.
- Insert the device in the correct direction. Otherwise this can damage device or TV.
- Electrical interference, static electricity, or erroneous operation may damage the data or device.
- Back up the recorded data at regular intervals in case of deteriorated or damaged data or erratic operation of the TV.
Panasonic is not liable for any deterioration or damage of recorded data.

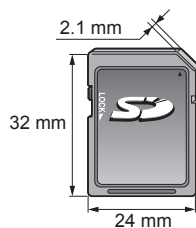

HDMI connection

HDMI (high-definition multimedia interface) is the world's first complete digital consumer AV interface complying with a non-compression standard.

HDMI allows you to enjoy high-definition digital images and high-quality sound by connecting the TV and the equipment.

HDMI-compatible equipment*1 with an HDMI or DVI output terminal, such as a DVD player, a set top box or game equipment, can be connected to the HDMI terminal using an HDMI compliant (fully wired) cable.

For more information about connections ➔ (p. 13, 77)

■ Applicable HDMI features

- Input audio signal:
2ch Linear PCM (sampling frequencies - 48 kHz, 44.1 kHz, 32 kHz)
- Input video signal:
➔ **"Input signal that can be displayed"** (p. 88)
Match the output setting of the digital equipment.
- Input PC signal:
➔ **"Input signal that can be displayed"** (p. 88)
Match the output setting of the PC.
- VIERA Link (HDAVI Control 5)
➔ **[VIERA Link]** (p. 72)
- 3D
- Content Type
- Deep Colour
- Audio Return Channel*2
(HDMI2 terminal only)

■ DVI connection

If the external equipment has only a DVI output, connect to the HDMI terminal via a DVI to HDMI adaptor cable*3. When the DVI to HDMI adaptor cable is used, connect the audio cable to AUDIO terminal with the supplied AV2 IN (COMPONENT / VIDEO) adaptor.

Note

- Audio settings can be made on [HDMI1 / 2 / 3 / 4 Input] in the Sound Menu. (p. 40)
- If the connected equipment has an aspect adjustment function, set the aspect ratio to "16:9".
- These HDMI connectors are "type A".
- These HDMI connectors are compatible with HDCP (High-Bandwidth Digital Content Protection) copyright protection.
- Equipment having no digital output terminal may be connected to the input terminal of component or video to receive analogue signals.
- This TV incorporates HDMI™ technology.

*1: The HDMI logo is displayed on HDMI-compliant equipment.

*2: Audio Return Channel (ARC) is a function to send digital sound signals via an HDMI cable.

*3: Enquire at your local digital equipment retailer shop.

PC connection

A PC may be connected to this TV so that the PC screen is displayed and sound is heard from the TV.

- A PC adaptor is not necessary for the DOS/V-compliant D-sub 15-pin connector.
- Some PC models cannot be connected to this TV.
- When using PC, set the colour display quality of PC to the highest position.
- For details of the applicable PC signals ➔ **"Input signal that can be displayed"** (p. 88)
- Maximum display resolution

Aspect	4:3	1,440 × 1,080 pixels
	16:9	1,920 × 1,080 pixels

- D-sub 15-pin connector signal



Pin No.	Signal Name	Pin No.	Signal Name	Pin No.	Signal Name
①	R	⑥	GND (Ground)	⑪	NC (not connected)
②	G	⑦	GND (Ground)	⑫	NC (not connected)
③	B	⑧	GND (Ground)	⑬	HD
④	NC (not connected)	⑨	NC (not connected)	⑭	VD
⑤	GND (Ground)	⑩	GND (Ground)	⑮	NC (not connected)

USB connection

- It is recommended to connect the USB Flash Memory or Communication Camera to the TV's USB ports directly.
- Some USB devices or USB HUB may not be used with this TV.
- You cannot connect any devices by using USB card reader.
- You cannot use two or more same kind of USB devices simultaneously except USB Flash Memory.
- Additional information for USB devices may be on the following website. (English only)
<http://panasonic.jp/support/global/cs/tv/>

■ USB Keyboard

- The USB Keyboard requiring its driver is not supported.
- Characters may not be displayed correctly on the TV screen depending on the connected keyboard.
- Some of the keys of USB keyboards may correspond to the operation of the remote control.

USB Keyboard	Remote Control	USB Keyboard	Remote Control
↑/↓/←/→	Cursor buttons	F2	VIERA TOOLS
Enter	OK	F3	MENU
Backspace	RETURN	F4	INPUT (AV)
Esc	EXIT	F5 / F6	Channel Down / Up
0 - 9 / Character	Numeric buttons	F7 / F8	Volume Down / Up
F1	-	F9 / F10 / F11 / F12	Coloured buttons

■ Gamepad

- Check the gamepads that have been tested for the performance with this TV at the following website. (English only)
<http://panasonic.jp/support/global/cs/tv/>
- Some of the keys of gamepads correspond to the operation of the remote control.

Example:

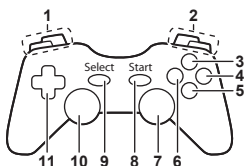

	Remote Control	Remote Control
1	Volume Up / Down	7 VIERA TOOLS
2	Channel Up / Down	8 EXIT
3	-	9 INPUT (AV)
4	OK	10 MENU
5	RETURN	11 Cursor buttons
6	INTERNET	

Characters table for numeric buttons

You can enter characters by using numeric buttons for free input items. (English only)

User input
Name
A B C D E F G H I J K L M N O P Q R S T
U V W X Y Z 0 1 2 3 4 5 6 7 8 9 ! : #
a b c d e f g h i j k l m n o p q r s t
u v w x y z () + - * _



Press the numeric button repeatedly until you reach the desired character.

- The character is set automatically if you leave for 1 second.
- You can also set the character by pressing the OK button or other numeric buttons within 1 second.
- The characters may vary depending on the input items.

Characters table:

Numeric buttons	Characters	Numeric buttons	Characters
1	. @ / ! : # + - * _ () " ' % & ? , ; = \$ [] ~ < > { } ` ^ \	6	m n o 6 M N O
2	a b c 2 A B C	7	p q r s 7 P Q R S
3	d e f 3 D E F	8	t u v 8 T U V
4	g h i 4 G H I	9	w x y z 9 W X Y Z
5	j k l 5 J K L	0	Space 0

Input signal that can be displayed

■ COMPONENT (Y, P_B, P_R (from AV2 IN terminal)), HDMI

Signal name	COMPONENT	HDMI
525 (480) / 60i, 60p	○	○
625 (576) / 50i, 50p	○	○
750 (720) / 60p, 50p	○	○
1,125 (1,080) / 60i, 50i	○	○
1,125 (1,080) / 60p, 50p, 24p		○

○ : Applicable input signal

■ PC (from D-sub 15P)

Signal name	Horizontal frequency (kHz)	Vertical frequency (Hz)
640 × 480 @60 Hz	31.47	59.94
800 × 600 @60 Hz	37.88	60.32
852 × 480 @60 Hz	31.44	59.89
1,024 × 768 @60 Hz	48.36	60.00
1,280 × 1,024 @60 Hz	63.98	60.02
1,280 × 768 @60 Hz	47.70	60.00
1,366 × 768 @60 Hz	48.39	60.04

Applicable input signal for PC is basically compatible to VESA standard timing.

■ PC (from HDMI terminal)

Signal name	Horizontal frequency (kHz)	Vertical frequency (Hz)
640 × 480 @60 Hz	31.47	60.00
1,280 × 720 @60 Hz	45.00	60.00
1,920 × 1,080 @60 Hz	67.50	60.00

Applicable input signal for PC is basically compatible to HDMI standard timing.

Note

- Signals other than above may not be displayed properly.
- The above signals are reformatted for optimal viewing on your display.
- PC signal is magnified or compressed for display, so that it may not show fine detail with sufficient clarity.

FAQs

Before requesting service or assistance, please follow these simple guides to resolve the problem. If the problem still persists, please contact your local Panasonic dealer for assistance.

White spots or shadow images (noise)

- Check the position, direction, and connection of the aerial.

Neither image nor sound is produced

- Check the TV is turned on.
- Check the mains lead is plugged into the TV and the socket outlet.
- Check the TV is in AV mode.
- Check the correct input mode is selected.
- Check the Picture Menu (p. 37 - 39) and volume.
- Check all required cables and connections are firmly in place.

Black and white picture

- Check that the output of the external equipment matches the input of the TV.

[VIERA Link] function does not work and an error message appears

- Confirm the connection. ➔ (p. 70, 71)
- Turn the connected equipment on and then switch the TV on. ➔ (p. 72)

There may be red spots, blue spots, green spots and black spots on the screen

- This is a characteristic of liquid crystal panels and is not a problem. The liquid crystal panel is built with very high precision technology giving you fine picture details. Occasionally, a few non-active pixels may appear on the screen as a fixed point of red, green, blue or black. Please note this does not affect the performance of your LCD, and it is not a quality problem.

	Problem	Causes / Actions
Screen	Chaotic image, noisy	<ul style="list-style-type: none"> • Set [P-NR] in the Picture Menu to remove noise. ➔ (p. 38) • Check nearby electrical products (car, motorcycle, fluorescent lamp).
	No image can be displayed	<ul style="list-style-type: none"> • Is [Contrast], [Brightness] or [Colour] in the Picture Menu set to the minimum? ➔ (p. 37) • Check the setting of [AV2] ([COMPONENT] / [VIDEO]) in [Input Selection] to match the output of the external equipment. (p. 25)
	Blurry or distorted image (no sound or low volume)	<ul style="list-style-type: none"> • Reset channels. ➔ (p. 44, 45)
	Unusual image is displayed	<ul style="list-style-type: none"> • Turn the TV off with Mains power On / Off switch, then turn it on again. • If the problem persists, initialise all settings. ➔ [Shipping Condition] (p. 47)

	Problem	Causes / Actions
Sound	No sound is produced	<ul style="list-style-type: none"> Is "Sound mute" active? ➔(p. 10) Is the volume set to the minimum?
	Sound level is low or sound is distorted	<ul style="list-style-type: none"> Sound signal reception may be deteriorated. Set [MPX] (p. 40) in the Sound Menu to [Mono].
3D	Cannot view 3D images	<ul style="list-style-type: none"> Has the 3D Eyewear been switched on and registered with this TV? ➔(p. 30) Is the 3D Eyewear mode set to 3D? Slide the tab once to the "MODE" position to change the mode between 3D and 2D. ➔(p. 29) Check the remaining battery level of the 3D Eyewear. Does the 3D Eyewear support Bluetooth wireless technology? ➔(p. 28) Ensure that [3D Mode Selection] is set to [3D]. ➔(p. 33) Some 3D image signals may not be automatically recognised as 3D images. Set [3D Mode Selection (Manual)] to match the picture format. ➔(p. 33) Check that there are no obstacles between the TV and the 3D Eyewear. Check the available area to use the 3D Eyewear. ➔(p. 30) For some people, the 3D images may be difficult to see, or cannot be seen, especially in users who have a different level of eyesight between the left and right eyes. Take the necessary steps (wearing glasses etc.) to correct your eyesight before use.
	3D Eyewear is turned off automatically	<ul style="list-style-type: none"> Check that there are no obstacles between the TV and the 3D Eyewear.
	There is something wrong with the 3D images	<ul style="list-style-type: none"> Check the setting of [Picture Sequence] or [Edge Smoother]. ➔(p. 34)
	The indicator lamp does not light when pressing the power button on the 3D Eyewear	<ul style="list-style-type: none"> The battery may be running low or flat. Replace it.
HDMI	Sound is unusual	<ul style="list-style-type: none"> Set the sound setting of the connected equipment to "2ch L.PCM". Check the [HDMI1 / 2 / 3 / 4 Input] setting in the Sound Menu. ➔(p. 40) If digital sound connection has a problem, select analogue sound connection. ➔(p. 86)
	Pictures from external equipment are unusual when the equipment is connected via HDMI	<ul style="list-style-type: none"> Check the HDMI cable is connected properly. ➔(p. 77) Turn the TV and equipment off, then turn them on again. Check an input signal from the equipment. ➔(p. 88) Use equipment compliant with EIA/CEA-861/861D.
Network	Cannot connect to the network	<ul style="list-style-type: none"> Check the LAN cable or wireless LAN is connected properly. ➔(p. 61) Check the connections and settings. ➔(p. 61 - 65) Check the network equipment and network environment. The router may not be set to issue IP address automatically. If the network administrator prefers to allocate an IP address, set an IP address manually. ➔(p. 63) The router may be using MAC address filtering (security setting). Confirm the MAC Address of this TV (p. 40) and set the router to use it. If the problem persists, consult your Internet Service Provider or telecommunications company.
	Cannot select the file during DLNA operations	<ul style="list-style-type: none"> Is media server of the connected equipment prepared? ➔(p. 60) Check applicable data format. ➔(p. 82, 83)
	Cannot operate VIERA Connect	<ul style="list-style-type: none"> Check the connections and settings. ➔(p. 61 - 65) The server or connected line may be busy now.

	Problem	Causes / Actions
Other	The TV does not switch on	<ul style="list-style-type: none"> • Check the mains lead is plugged into the TV and the socket outlet.
	The TV goes into Standby mode	<ul style="list-style-type: none"> • Auto power standby function is activated. ➔ (p. 11) • The TV enters Standby mode about 30 minutes after broadcasting ends.
	The remote control does not work or is intermittent	<ul style="list-style-type: none"> • Are the batteries installed correctly? ➔ (p. 7) • Has the TV been switched on? • The batteries may be running low. Replace them. • Point the remote control directly at the TV's remote control signal receiver (within about 7 m and a 30 degree angle of the signal receiver). • Situate the TV away from sunshine or other sources of bright light not to shine on the TV's remote control signal receiver.
	Parts of the TV become hot	<ul style="list-style-type: none"> • Even when the temperature of parts of the front, top and rear panels has risen, these temperature rises do not cause any problems in terms of performance or quality.
	The LCD panel moves slightly when it is pushed with a finger Clattered sound might be heard	<ul style="list-style-type: none"> • There is some flexibility around the panel to prevent damage to the panel. • The panel might move slightly when it is pushed with a finger, and clattered sound might be heard. This is not a malfunction.
	Overcurrent error message appears	<ul style="list-style-type: none"> • The connected USB device might cause this error. Remove the device and turn the TV off with Mains power On / Off switch, then turn it on again. • Check foreign objects are not inside the USB port.
An error message appears	<ul style="list-style-type: none"> • Follow the message's instructions. • If the problem persists, contact your local Panasonic dealer or the authorised service centre. 	

Maintenance

First, remove the mains plug from the socket outlet.

Display panel, Cabinet, Pedestal

Regular care:

Gently wipe the surface of the display panel, cabinet, or pedestal by using a soft cloth to clean the dirt or fingerprints.

For stubborn dirt:

First clean the dust on the surface. Dampen a soft cloth with clean water or diluted neutral detergent (1 part detergent to 100 parts water). Wring the cloth and wipe the surface. Finally, wipe away all the moisture.

Caution

- Do not use a hard cloth or rub the surface too hard, otherwise this may cause scratches on the surface.
- Take care not to subject the TV's surfaces to water or detergent. Liquid inside the TV could lead to product failure.
- Take care not to subject the surfaces to insect repellent, solvent, thinner or other volatile substances. This may degrade surface quality or cause peeling of the paint.
- The surface of the display panel is specially treated and may be easily damaged. Take care not to tap or scratch the surface with your fingernail or other hard objects.
- Do not allow the cabinet and pedestal to make contact with a rubber or PVC substance for a long time. This may degrade surface quality.

Mains plug

Wipe the mains plug with a dry cloth at regular intervals. Moisture and dust may lead to fire or electrical shock.

Specifications

TV		DT50 series		ET50 series																							
Model No.		TH-L42DT50K TH-L42DT50M TH-L42DT50T	TH-L47DT50K TH-L47DT50M TH-L47DT50T TH-L47DT50X	TH-L42ET50K TH-L42ET50M TH-L42ET50T	TH-L47ET50K TH-L47ET50M TH-L47ET50T																						
Speakers	Speaker	8 train speakers × 2, Woofer (Φ 75 mm) × 1																									
	Audio output	18 W (4 W + 4 W + 10 W)																									
	Headphones	M3 (3.5 mm) stereo mini Jack × 1																									
Receiving systems / Band name		<table border="1"> <thead> <tr> <th>17 Systems</th> <th>Function</th> </tr> </thead> <tbody> <tr><td>1 PAL B, G, H</td><td rowspan="7">Reception of broadcast transmissions and Playback from Video Cassette Tape Recorders</td></tr> <tr><td>2 PAL I</td></tr> <tr><td>3 PAL D, K</td></tr> <tr><td>4 SECAM B, G</td></tr> <tr><td>5 SECAM D, K</td></tr> <tr><td>6 SECAM K1</td></tr> <tr><td>7 NTSC M (NTSC 3.58/4.5 MHz)</td></tr> </tbody> </table>	17 Systems	Function	1 PAL B, G, H	Reception of broadcast transmissions and Playback from Video Cassette Tape Recorders	2 PAL I	3 PAL D, K	4 SECAM B, G	5 SECAM D, K	6 SECAM K1	7 NTSC M (NTSC 3.58/4.5 MHz)	<table border="1"> <thead> <tr> <th>17 Systems</th> <th>Function</th> </tr> </thead> <tbody> <tr><td>8 NTSC 4.43/5.5 MHz</td><td rowspan="5">Playback from Special VCR's or DVD</td></tr> <tr><td>9 NTSC 4.43/6.0 MHz</td></tr> <tr><td>10 NTSC 4.43/6.5 MHz</td></tr> <tr><td>11 NTSC 3.58/5.5 MHz</td></tr> <tr><td>12 NTSC 3.58/6.0 MHz</td></tr> <tr><td>13 NTSC 3.58/6.5 MHz</td></tr> <tr><td>14 SECAM I</td><td rowspan="3">Playback from Special Disc Players and Special VCR's or DVD</td></tr> <tr><td>15 PAL 60 Hz/5.5 MHz</td></tr> <tr><td>16 PAL 60 Hz/6.0 MHz</td></tr> <tr><td>17 PAL 60 Hz/6.5 MHz</td></tr> </tbody> </table>	17 Systems	Function	8 NTSC 4.43/5.5 MHz	Playback from Special VCR's or DVD	9 NTSC 4.43/6.0 MHz	10 NTSC 4.43/6.5 MHz	11 NTSC 3.58/5.5 MHz	12 NTSC 3.58/6.0 MHz	13 NTSC 3.58/6.5 MHz	14 SECAM I	Playback from Special Disc Players and Special VCR's or DVD	15 PAL 60 Hz/5.5 MHz	16 PAL 60 Hz/6.0 MHz	17 PAL 60 Hz/6.5 MHz
17 Systems	Function																										
1 PAL B, G, H	Reception of broadcast transmissions and Playback from Video Cassette Tape Recorders																										
2 PAL I																											
3 PAL D, K																											
4 SECAM B, G																											
5 SECAM D, K																											
6 SECAM K1																											
7 NTSC M (NTSC 3.58/4.5 MHz)																											
17 Systems	Function																										
8 NTSC 4.43/5.5 MHz	Playback from Special VCR's or DVD																										
9 NTSC 4.43/6.0 MHz																											
10 NTSC 4.43/6.5 MHz																											
11 NTSC 3.58/5.5 MHz																											
12 NTSC 3.58/6.0 MHz																											
13 NTSC 3.58/6.5 MHz																											
14 SECAM I	Playback from Special Disc Players and Special VCR's or DVD																										
15 PAL 60 Hz/5.5 MHz																											
16 PAL 60 Hz/6.0 MHz																											
17 PAL 60 Hz/6.5 MHz																											
Receiving Channels		VHF BAND 2-12 (PAL/SECAM B, K1) 0-12 (PAL B AUST.) 1-9 (PAL B N.Z.) 1-12 (PAL/SECAM D) 1-12 (NTSC M Japan) 2-13 (NTSC M USA)	UHF BAND 21-69 (PAL G, H, I/SECAM G, K, K1) 28-69 (PAL B AUST.) 13-57 (PAL D, K) 13-62 (NTSC M Japan) 14-69 (NTSC M USA)	CATV S1-S20 (OSCAR) 1-125 (USA CATV) C13-C49 (JAPAN) S21-S41 (HYPER) Z1-Z37 (CHINA) 5A, 9A (AUST.)																							
Aerial - Rear		VHF / UHF																									
Operating Conditions		Temperature: 0 °C - 40 °C Humidity: 20 % - 80 % RH (non-condensing)																									

Connection terminals	AV1 IN	AUDIO L - R	RCA PIN Type × 2	0.5 V[rms]	
		VIDEO	RCA PIN Type × 1	1.0 V[p-p] (75 Ω)	
	AUDIO OUT	AUDIO L - R	RCA PIN Type × 2	0.5 V[rms] (high impedance)	
		AUDIO L - R	RCA PIN Type × 2	0.5 V[rms]	
	AV2 IN	COMPONENT	Y	1.0 V[p-p] (including synchronisation)	
			P _B /C _B , P _R /C _R	±0.35 V[p-p]	
		VIDEO	RCA PIN Type × 1	1.0 V[p-p] (75 Ω)	
	HDMI 1 / 2 / 3 / 4 input	TYPE A Connectors • This TV supports "HDAVI Control 5" function.			
	PC	HIGH-DENSITY D-SUB 15PIN R,G,B: 0.7 V[p-p] (75 Ω) HD, VD: TTL Level 2.0 – 5.0 V[p-p] (high impedance) • Applicable input signals: VGA, SVGA, WVGA, XGA SXGA, WXGA			
	Card slot	SD Card slot × 1			
ETHERNET	10BASE-T / 100BASE-TX				
USB 1 / 2 / 3	USB 2.0 TYPE A Connectors DC 5 V, Max. 500 mA				
DIGITAL AUDIO OUT	PCM / Dolby Digital / DTS, Fibre optic				
Built-in wireless LAN	Standard compliance and Frequency range*1	IEEE802.11a/n 5.15 GHz - 5.35 GHz, 5.47 GHz - 5.85 GHz IEEE802.11b/g/n 2.40 GHz - 2.4835 GHz			
	Security	WPA2-PSK (TKIP/AES) WPA-PSK (TKIP/AES) WEP (64 bit/128 bit)			
Bluetooth wireless technology*2	Standard Compliance	Bluetooth 3.0			
	Frequency Range	2.402 GHz - 2.480 GHz			

*1 The frequency and channel differ depending on the country.

*2 Not all the Bluetooth compatible devices are available with this TV.

TV (continue)

DT50 series		42" class		47" class	
Model No.		TH-L42DT50K TH-L42DT50M	TH-L42ET50T	TH-L47DT50K TH-L47DT50M	TH-L47DT50T TH-L47DT50X
Power Source		AC 110-240 V, 50 / 60 Hz			
Power Consumption	Power Rating	107 W		120 W	
	Standby condition	0.2 W		0.2 W	
Display panel	Panel system	IPS LED backlight Liquid Crystal Display			
	Visible screen size (diagonal)	107 cm / 42 inches		119 cm / 47 inches	
	Number of pixels	2,073,600 (1,920 (W) × 1,080 (H))			
Dimensions (W × H × D)		958 mm × 615 mm × 258 mm (With Pedestal) 958 mm × 569 mm × 27 mm (TV only)		1,067 mm × 677 mm × 265 mm (With Pedestal) 1,067 mm × 631 mm × 27 mm (TV only)	
Mass		14.5 kg Net (With Pedestal) 11.0 kg Net (TV only)		17.0 kg Net (With Pedestal) 13.0 kg Net (TV only)	

ET50 series		42" class		47" class	
Model No.		TH-L42ET50K TH-L42ET50M	TH-L42ET50T	TH-L47ET50K TH-L47ET50M	TH-L47ET50T
Power Source		AC 110-240 V, 50 / 60 Hz			
Power Consumption	Power Rating	122 W		138 W	
	Standby condition	0.3 W		0.3 W	
Display panel	Panel system	IPS LED backlight Liquid Crystal Display			
	Visible screen size (diagonal)	107 cm / 42 inches		119 cm / 47 inches	
	Number of pixels	2,073,600 (1,920 (W) × 1,080 (H))			
Dimensions (W × H × D)		989 mm × 643 mm × 249 mm (With Pedestal) 989 mm × 595 mm × 36 mm (TV only)		1,098 mm × 704 mm × 256 mm (With Pedestal) 1,098 mm × 656 mm × 36 mm (TV only)	
Mass		19.0 kg Net (With Pedestal) 15.5 kg Net (TV only)		19.0 kg Net (With Pedestal) 15.0 kg Net (TV only)	

Specifications
3D Eyewear

Dimensions (W × H × D)	167.7 mm × 42.2 mm × 170.7 mm
Mass	Approx. 31 g
Lens type	Liquid Crystal Shutter
Usage temperature range	0 °C - 40 °C
Battery*	Coin-shaped lithium battery CR2025 Operation time: Approx. 75 hours in continuous use of the battery made by Panasonic
Viewing range*	Within 3.2 m from front surface of the TV
Materials	Main body: Resin Lens section: Liquid crystal glass
Communication system	2.4 GHz band FH-SS (Frequency Hopping Spread Spectrum)

* There are differences in the viewing range of the 3D Eyewear among individuals.

• The 3D Eyewear may not operate correctly at the outside of the viewing range.

Note

• Design and Specifications are subject to change without notice. Mass and Dimensions shown are approximate.

Licence

Even if no special notation has been made of company or product trademarks, these trademarks have been fully respected.

This product incorporates the following software or technology:

- (1) the software developed independently by or for Panasonic Corporation,
- (2) the software owned by third party and licensed to Panasonic Corporation,
- (3) the software based in part on the work of the Independent JPEG Group,
- (4) the software developed by the FreeType Project,
- (5) the software licensed under the GNU LESSER GENERAL PUBLIC LICENSE (LGPL) and/or,
- (6) open sourced software other than the software licensed under the LGPL.
- (7) "PlayReady"(digital right management technology) licensed by Microsoft Corporation or its affiliates.

For the software categorized as (5), please refer to the terms and conditions of LGPL, as the case may be at <http://www.gnu.org/licenses/old-licenses/lgpl-2.1.html>

In addition, the software categorized as (5) are copyrighted by several individuals.

Please refer to the copyright notice of those individuals at

<http://www.am-linux.jp/dl/EUIDTV12/>

The LGPL software is distributed in the hope that it will be useful, but WITHOUT ANY WARRANTY, without even the implied warranty of MERCHANTABILITY or FITNESS FOR A PARTICULAR PURPOSE.

At least three (3) years from delivery of products, Panasonic will give to any third party who contact us at the contact information provided below, for a charge no more than our cost of physically performing source code distribution, a complete machine-readable copy of the corresponding source code covered under LGPL.

Contact Information

cdrequest@am-linux.jp

Source code covered under LGPL is also freely available to you and any other member of the public via our website below.

<http://www.am-linux.jp/dl/EUIDTV12/>

For the software categorized as (5) and (6), please refer to the applicable license terms included in the "Setup" menu on product.

Further, for PlayReady categorized as (7), please be aware of the following.

- (a) This product contains technology subject to certain intellectual property rights of Microsoft. Use or distribution of this technology outside of this product is prohibited without the appropriate license(s) from Microsoft.
- (b) Content owners use Microsoft PlayReady(TM) content access technology to protect their intellectual property, including copyrighted content. This device uses PlayReady technology to access PlayReady-protected content and/or WMDRM-protected content. If the device fails to properly enforce restrictions on content usage, content owners may require Microsoft to revoke the device's ability to consume PlayReady-protected content. Revocation should not affect unprotected content or content protected by other content access technologies.

Content owners may require you to upgrade PlayReady to access their content.

If you decline an upgrade, you will not be able to access content that requires the upgrade.

Information on Disposal in other Countries outside the European Union



This symbol is only valid in the European Union. If you wish to discard this product, please contact your local authorities or dealer and ask for the correct method of disposal.



Customer's Record

The model number and serial number of this product may be found on its rear panel. You should note this serial number in the space provided below and retain this book, plus your purchase receipt, as a permanent record of your purchase to aid in identification in the event of theft or loss, and for Warranty Service purposes.

Model Number

Serial Number

Panasonic Corporation

Web Site: <http://panasonic.net>

M0212-1032

© Panasonic Corporation 2012

Printed in Malaysia