

Licence

Even if no special notation has been made of company or product trademarks, these trademarks have been fully respected.

- VGA is a trademark of International Business Machines Corporation.
- S-VGA is a registered trademark of the Video Electronics Standard Association.
- SDHC Logo is a trademark.
- HDMI, the HDMI Logo and High-Definition Multimedia Interface are trademarks or registered trademarks of HDMI Licensing LLC in the United States and other countries.
- HDAVI Control™ is a trademark of Panasonic Corporation.
- x.v.Colour™ is a trademark.
- Macintosh is a trademark of Apple Inc.

This product incorporates the following software:

- (1) software developed independently by or for Panasonic Corporation,
- (2) software owned by a third party and licensed to Panasonic Corporation,
- (3) software licensed under the GNU General Public License, Version 2 (GPL v2),
- (4) software licensed under the GNU LESSER General Public License (LGPL) and/or,
- (5) open source software other than software licensed under the GPL and/or LGPL

For the software categorized as (3) or (4), please refer to the terms and conditions of GPL v2 and LGPL, as the case may be. at <http://www.gnu.org/licenses/old-licenses/gpl-2.0.html> and <http://www.gnu.org/licenses/old-licenses/lgpl-2.1.html>

In addition, software categorized as (3) or (4) is copyrighted by several individuals and/or entities. Please refer to the copyright notice of those individuals at <http://www.am-linux.jp/dl/DTV10AT/>

GPL/LGPL SOFTWARE IS DISTRIBUTED IN THE HOPE THAT IT WILL BE USEFUL, BUT WITHOUT ANY WARRANTY, EXPRESS, IMPLIED OR STATUTORY, INCLUDING THE IMPLIED WARRANTIES OF MERCHANTABILITY OR FITNESS FOR A PARTICULAR PURPOSE.

For at least three (3) years from delivery of products, Panasonic will give to anyone who contacts us at the address provided below, for a charge of no more than our cost of physically performing source code distribution, a complete machine-readable copy of the corresponding source code covered under GPL v2/LGPL.

Contact Information

cdrequest@am-linux.jp

Source code is also freely available to you and any other member of the public via our website below.

<http://www.am-linux.jp/dl/DTV10AT/>

Customer's Record

The model number and serial number of this product may be found on its rear panel. You should note the model number and the serial number in the space provided below and retain this book, plus your purchase receipt, as a permanent record of your purchase to aid in identification in the event of theft or loss, and for Warranty Service purposes.

Model Number

Serial Number

Panasonic Corporation

Web Site: <http://panasonic.net>

© Panasonic Corporation 2010

Printed in Singapore
M0210-0

Panasonic®

Model No.

TH-P42X20K	TH-P46X20P
TH-P42X20M	TH-P46X20R
TH-P42X20P	TH-P46X20V
TH-P42X20R	TH-P50X20K
TH-P42X20V	TH-P50X20M
TH-P46X2G	TH-P50X20P
TH-P46X20K	TH-P50X20R
TH-P46X20M	TH-P50X20V

Operating Instructions Plasma Television

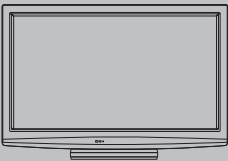

VIERA

VIERA
Link

VIERA
IMAGE VIEWER

SD
HG

HDMI

Thank you for purchasing this Panasonic product. Please read these instructions before operating your set and retain them for future reference. The images shown in this manual are for illustrative purposes only.

English

TQB3EC0013

Experience an amazing level of multimedia excitement

Sharp pictures with HDMI terminal

Create home theatre and DVD recorder link-ups with "VIERA Link" without complicated settings!

Enjoy rich multimedia

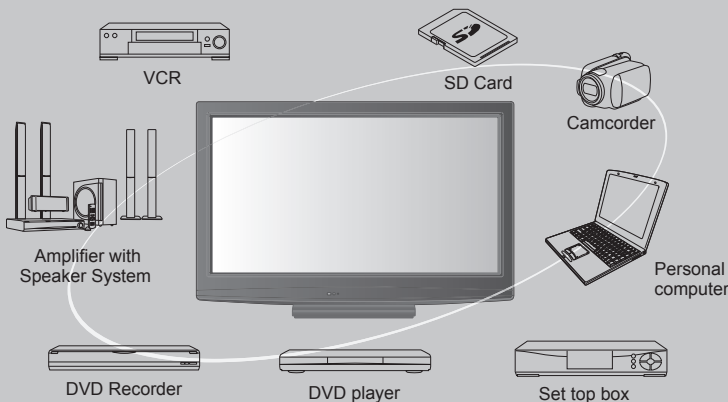

Standard accessories ● Pedestal types vary between models.

Check that you have the accessories and items shown

- Remote Control
- N2QAYB000370



- Batteries for the Remote Control (2)
- R6 (AA)



- Pedestal
- ➔ p. 6

(TH-P46X2G
TH-P46X20K
TH-P46X20V
TH-P50X20K
TH-P50X20V)

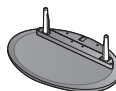

(TH-P42X20K
TH-P42X20M
TH-P42X20P
TH-P42X20R
TH-P42X20V
TH-P46X20M
TH-P46X20P
TH-P46X20R
TH-P50X20M
TH-P50X20P
TH-P50X20R)

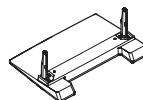

- Mains Lead
- ➔ p. 8



(TH-P42X20K TH-P46X20P
TH-P42X20M TH-P46X20V
TH-P42X20P TH-P50X20K
TH-P42X20V TH-P50X20M
TH-P46X20K TH-P50X20P
TH-P46X20M TH-P50X20V)

(TH-P46X2G
TH-P42X20R
TH-P46X20R
TH-P50X20R)

- Operating Instructions

Caution

- This product contains possibly dangerous parts (such as plastic bags), which can be breathed in or swallowed by young children accidentally. Keep these parts out of reach of young children.

Contents

Be sure to Read

- Safety Precautions 4
(Warning / Caution)

Quick Start Guide

- Accessories / Options 6
- Basic Connection 8
- Identifying Controls 10
- Auto Tuning 12

Quick Start
Guide

Basic Features

- Watching TV 13
- Viewing Teletext 16
- Watching External inputs 18

Basic

Advanced Features

- How to Use VIERA TOOLS 20
- How to Use Menu Functions 21
- Tuning and Editing Channels 27
- Child Lock 29
- Input Labels 30
- Shipping Condition (Reset settings) 31
- Viewing from SD Card
(VIERA IMAGE VIEWER) 32
- VIERA Link Functions 34
- VIERA Link "HDAVI Control"™ 36
- External Equipment 38

Advanced

Technical

- Technical Information 40
- Maintenance 45
- FAQs 45
- Specifications 47
- Licence 48

Technical

Inserting and removing remote's batteries

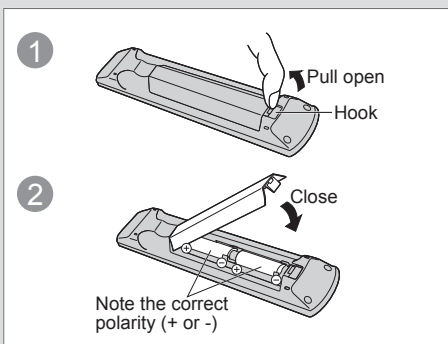

Caution

- Incorrect installation may cause battery leakage and corrosion, resulting in damage to the remote control.
- Do not mix old and new batteries.
- Do not mix different battery types (such as alkaline and manganese batteries).
- Do not use rechargeable (Ni-Cd) batteries.
- Do not burn or breakup batteries.
Batteries must not be exposed to excessive heat such as sunshine, fire or the like.
- Do not disassemble or modify the remote control.

Safety Precautions

Warning

Handling the mains plug and lead

- Insert the mains plug fully into the socket outlet. (If the mains plug is loose, it could generate heat and cause fire.)
- Ensure that the mains plug is easily accessible.
- Ensure the earth pin on the mains plug is securely connected to prevent electrical shock.
- Do not touch the mains plug with a wet hand. (This may cause electrical shock.)
- Do not use any mains lead other than that provided with this TV. (This may cause fire or electrical shock.)
- Do not damage the mains lead. (A damaged lead may cause fire or electrical shock.)
 - Do not move the TV with the lead plugged in the socket outlet.
 - Do not place a heavy object on the lead or place the lead near a high-temperature object.
 - Do not twist the lead, bend it excessively, or stretch it.
 - Do not pull on the lead. Hold onto the mains plug body when disconnecting lead.
 - Do not use a damaged mains plug or socket outlet.

If you find any abnormality, remove the mains plug immediately!



**AC 220 - 240 V, 50 / 60 Hz
(TH-P42X20P / TH-46X20P / TH-50X20P:
AC 110 - 240 V, 50 / 60 Hz)**



- Mains plug types vary between countries.

Power source

- This TV is designed to operate on AC 220 - 240 V, 50 / 60 Hz (TH-P42X20P / TH-46X20P / TH-50X20P: AC 110 - 240 V, 50 / 60 Hz)

Do not remove covers and NEVER modify the TV yourself

- Do not remove the rear cover as live parts are accessible when it is removed. There are no user serviceable parts inside. (High-voltage components may cause serious electrical shock.)
- Have the TV checked, adjusted, or repaired at your local Panasonic dealer.

Do not insert foreign objects into the TV

- Do not allow any objects to drop into the TV through the air vents. (Fire or electrical shock may result.)

Do not expose to rain or excessive moisture

- To prevent damage which might result in electric shock or fire, do not expose this TV to rain or excessive moisture. This TV must not be exposed to dripping or splashing water and objects filled with liquid, such as vases, must not be placed on top of or above the TV.

Do not expose to direct sunlight and other sources of heat

- Avoid exposing the TV to direct sunlight and other sources of heat. To prevent fire never place any type of candle or naked flame on top or near the TV.

Do not place the TV on sloped or unstable surfaces

- The TV may fall off or tip over.

Use only the dedicated pedestals / mounting equipment

- Using an unapproved pedestal or other fixtures may make the TV unstable, risking injury. Be sure to ask your local Panasonic dealer to perform setup.
- Use approved pedestals (p. 6) / wall-hanging brackets (p. 7).

Do not allow children to handle SD Card

- As with any small object, SD Cards can be swallowed by young children. Please remove SD Card immediately after use and store out of reach of children.

Caution

- **This appliance is intended for use in tropical climates**
- **When cleaning the TV, remove the mains plug**
 - Cleaning an energized TV may cause electrical shock.
- **When the TV is not going to be used for a long period of time, remove the mains plug**
 - This TV will still consume some power even in the Off mode, as long as the mains plug is still connected to a live socket outlet.
- **Transport only in upright position**
 - Transporting the TV with its display panel facing upward or downward may cause damage to the internal circuitry.
- **Allow sufficient space around the TV for radiated heat**
 - When using the pedestal, keep a space between the bottom of the TV and the surface where the TV is set.
 - In case of using Wall-hanging bracket, follow the manual of it.
- **Do not block the rear air vents**
 - Blocked ventilation by newspapers, table cloths, curtains, etc. may cause overheating, fire or electrical shock.
- **Do not apply strong force or impact to the display panel**
 - This may cause damage resulting in injury.
- **Do not expose your ears to excessive volume from the headphones**
 - Irreversible damage can be caused.
- **The TV is heavy. Handle the TV by 2 or more people. Support as shown to avoid injury by the TV tipping or falling.**

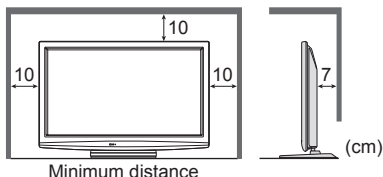

Note

- **Auto power standby function**
 - If no signal is received and no operation is performed for 30 minutes, the TV will automatically go to standby mode.
- **Keep the TV away from these types of equipment**
 - Electronic equipment
In particular, do not place video equipment near the TV. Electromagnetic interference may distort images / sound.
 - Equipment with an infrared sensor
This TV also emits infrared rays. This may affect operation of other equipment.



Do not display a still picture for a long time

This causes the image to remain on the plasma screen ("image retention"). This is not considered a malfunction and is not covered by the warranty.
Typical still images:



- Programme number and other logos
- Image displayed in "4:3" mode
- Video game
- Computer image

To prevent image retention, contrast is lowered automatically after a few minutes if no signals are sent or no operations are performed. (p. 45)

Adjust the panel to your desired angle (TH-P46X2G / TH-P46X20K / TH-P46X20V / TH-P50X20K / TH-P50X20V)

Set the mark at the centre as illustrated, to have the swivel positioned at the centre of the rotation angle.

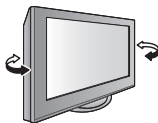

- Ensure that the pedestal does not hang over the edge of the base even if the TV swivels to the full rotation range.
- Do not place any objects or hands within the full rotation range.

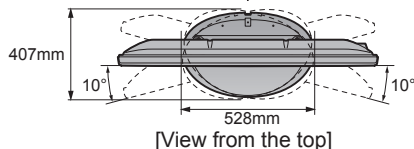

Accessories / Options

Attaching the pedestal

Warning

Do not disassemble or modify the pedestal.

- Otherwise the TV may fall over and become damaged, and personal injury may result.

Caution

Do not use the pedestal for any other TV or displays.

- Otherwise the TV or the display may fall over and become damaged, and personal injury may result.

Do not use the pedestal if it becomes warped or physically damaged.

- If you use the pedestal while it is physically damaged, personal injury may result. Contact your nearest Panasonic dealer immediately.

During set-up, make sure that all screws are securely tightened.

- If insufficient care is taken to ensure screws are properly tightened during assembly, the pedestal will not be strong enough to support the TV, and it might fall over and become damaged, and personal injury may result.

Ensure that the TV does not fall over.

- If the TV is knocked or children climb onto the pedestal with the TV installed, the TV may fall over and personal injury may result.

Two or more people are required to install and remove the TV.

- If two or more people are not present, the TV may be dropped, and personal injury may result.

TH-P46X2G / TH-P46X20K / TH-P46X20V / TH-P50X20K / TH-P50X20V

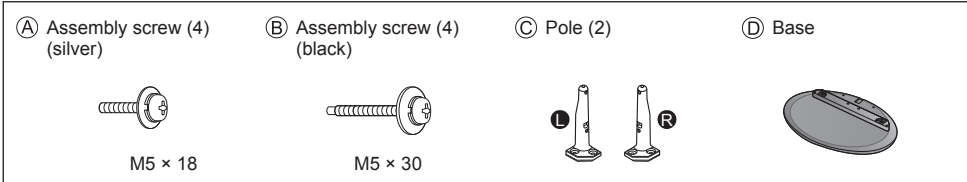

Assembling the pedestal

Use the assembly screws (A) to fasten the left and right poles (C) to the base (D) securely.

- Make sure that the screws are securely tightened.
- Forcing the assembly screws the wrong way will strip the threads.
- "L" or "R" mark is stamped on the bottom of the pole.

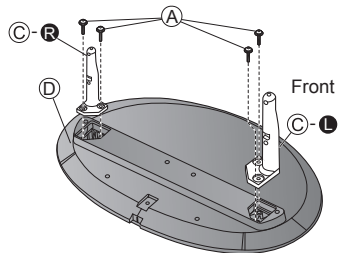

Securing the TV

Use the assembly screws (B) to fasten securely.

- Make sure that the screws are securely tightened.
- Carry out the work on a horizontal and level surface.

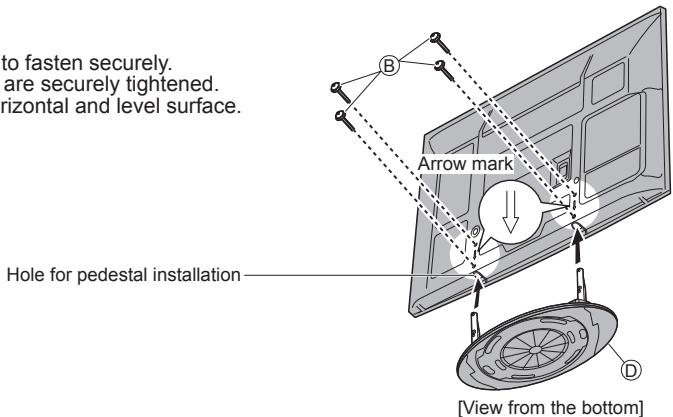

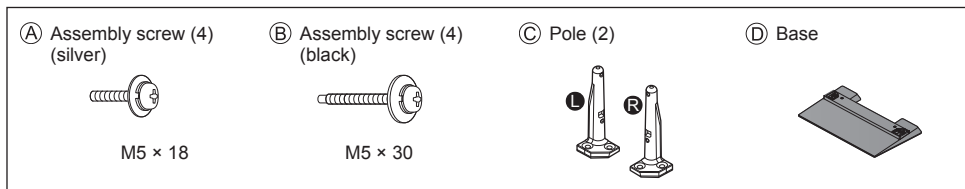

Assembling the pedestal

Use the assembly screws (A) to fasten the left and right poles (C) to the base (D) securely.

- Make sure that the screws are securely tightened.
- Forcing the assembly screws the wrong way will strip the threads.
- "L" or "R" mark is stamped on the bottom of the pole.

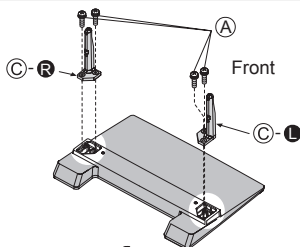

Securing the TV

Use the assembly screws (B) to fasten securely.

- Make sure that the screws are securely tightened.
- Carry out the work on a horizontal and level surface.

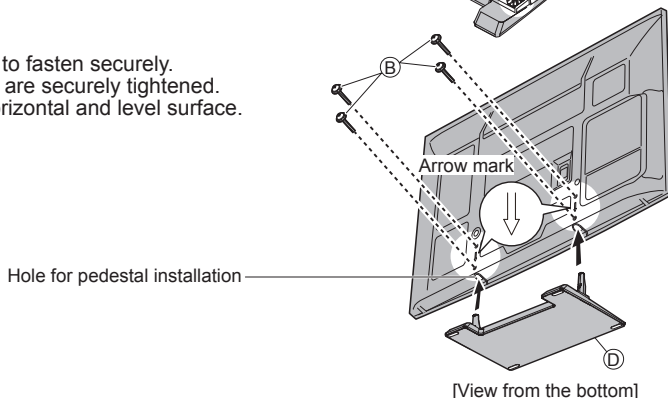

Optional accessories

Please contact your nearest Panasonic dealer to purchase the recommended wall-hanging bracket. For additional details, please refer to the wall-hanging bracket installation manual.

Wall-hanging bracket

- TY-WK4P1RW

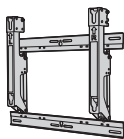

Rear of the TV

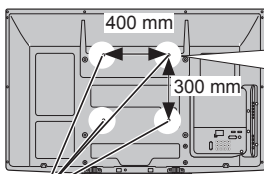

Holes for wall-hanging bracket installation

Screw for fixing the TV onto the wall-hanging bracket (not supplied with the TV)

Depth of screw:
minimum 15 mm,
maximum 30 mm

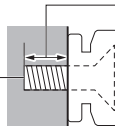

[View from the side]

Warning

- Using other wall-hanging brackets, or installing a wall-hanging bracket by yourself have the risk of personal injury and product damage. In order to maintain the unit's performance and safety, be absolutely sure to ask your dealer or a licensed contractor to secure the wall-hanging brackets. Any damage caused by installing without a qualified installer will void your warranty.
- Carefully read the instructions accompanying optional accessories, and be absolutely sure to take steps to prevent the TV from falling off.
- Handle the TV carefully during installation since subjecting it to impact or other forces may cause product damage.
- Take care when fixing wall brackets to the wall. Always ensure that there are no electrical cables or pipes in the wall before hanging bracket.
- To prevent fall and injury, remove the TV from its fixed wall position when it is no longer in use.

Basic Connection

External equipment and cables shown are not supplied with this TV.
Please ensure that the TV is disconnected from the mains socket before attaching or disconnecting any leads.
When disconnecting the main lead, be absolutely sure to disconnect the main plug at the socket outlet first.

Connecting aerial

TV only

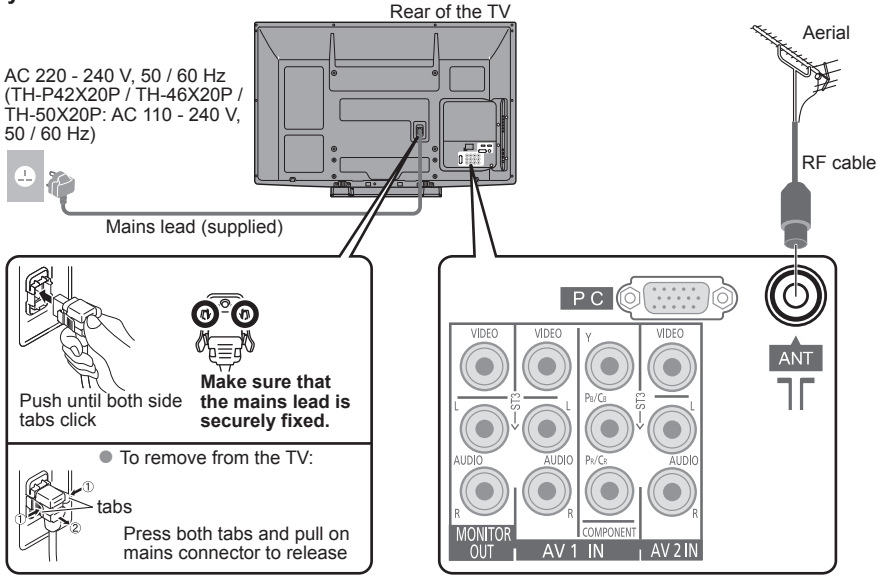

Note

- Mains plug types vary between countries.
- Do not put the RF cable close to the mains lead to avoid noise.
- Do not place the RF cable under the TV.
- To obtain optimum quality picture and sound, an aerial, the correct cable (75 Ω coaxial) and the correct terminating plug are required.
- If a communal aerial system is used, you may require the correct connection cable and plug between the wall aerial socket and the TV.
- Your local Television Service Centre or dealer may be able to assist you in obtaining the correct aerial system for your particular area and the accessories required.
- Any matters regarding aerial installation, upgrading of existing systems or accessories required, and the costs incurred, are the responsibility of you, the Customer.
- To obtain optimum quality picture, select either an Aerial or a cable TV network.
- VIERA Link connection \Rightarrow p. 34
- Read the manual of the equipment, too.
- Other equipment connection \Rightarrow p. 38 and p. 39

Connecting DVD Recorder / VCR

TV, DVD Recorder or VCR

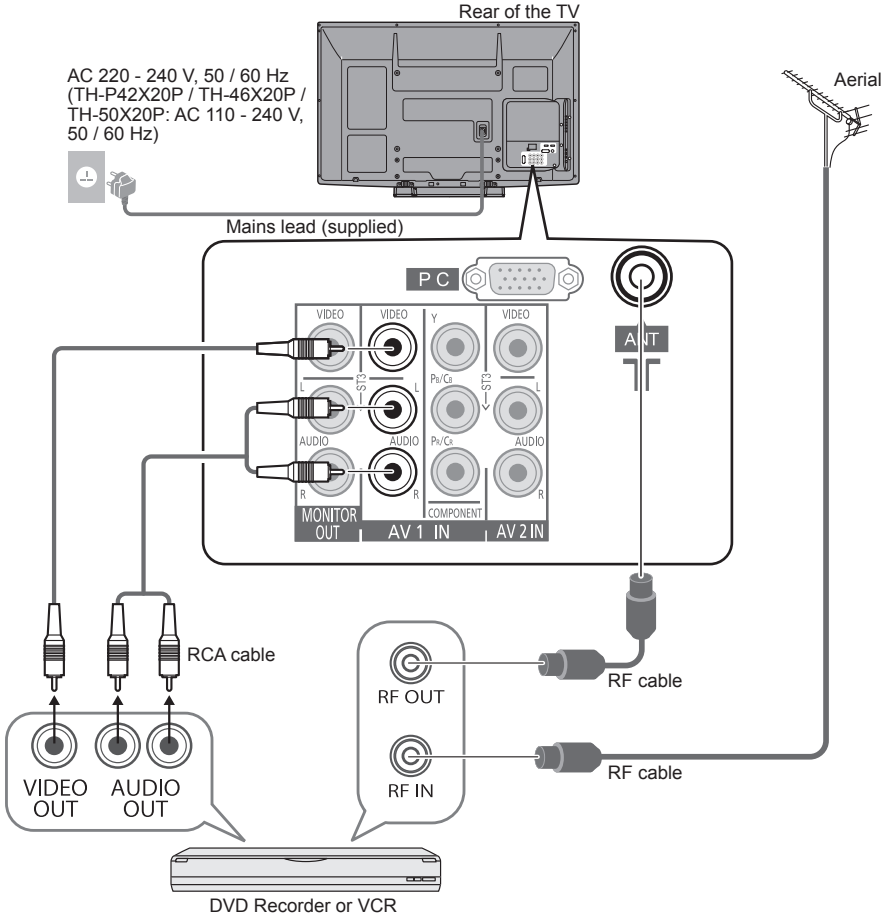

Identifying Controls

Remote control

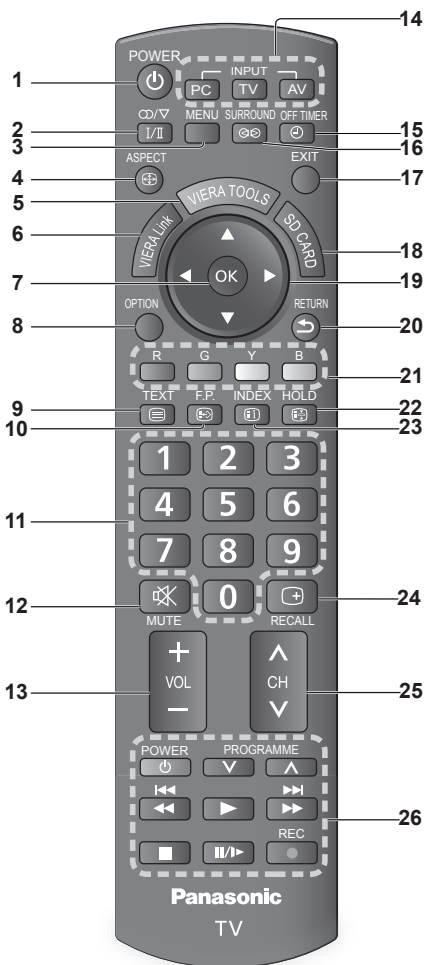

- 1 Standby On / Off switch**
 - Switches TV On or Off standby
- 2 Stereo / Bilingual Sound Selection (p. 41)**
- 3 Main Menu (p. 21)**
 - Press to access Picture, Sound and Setup Menus
- 4 Aspect (p. 15)**
 - Changes aspect ratio from Aspect Selection list
 - Also possible by pressing this button repeatedly until you reach the desired aspect
- 5 VIERA TOOLS (p. 20)**
 - Displays some special feature icons and accesses easily
- 6 VIERA Link (p. 34)**
 - Accesses VIERA Link Menu
- 7 OK**
 - Confirms selections and choices
 - Press after selecting channel positions to quickly change programme
- 8 Option Menu (p. 14)**
 - Easy setting for viewing and sound options
- 9 Teletext (p. 16)**
 - Switches to teletext mode
- 10 Favourite Page (p. 16)**
 - Calls up the teletext page stored in blue button.
- 11 Numeric buttons**
 - Changes channel and teletext pages
 - When in Standby mode, switches TV On
- 12 Sound Mute**
 - Switches sound mute On or Off
- 13 Volume Up / Down**
- 14 Input mode selection**
 - PC - switches to PC input mode (p. 18)
 - TV - switches TV mode (p. 13)
 - AV - switches to AV input mode from Input Selection list (p. 18)
- 15 Off Timer (p. 13)**
 - Sets the time the TV automatically turns off
- 16 Surround (p. 24)**
 - Switches surrounding sound setting
- 17 Exit**
 - Returns to the normal viewing screen
- 18 SD Card (p. 32)**
 - Switches to SD Card viewing mode.
- 19 Cursor buttons**
 - Makes selections and adjustments
- 20 Return**
 - Returns to the previous menu / page
- 21 Coloured buttons**
 - Used for the selection, navigation and operation of various functions
- 22 Hold**
 - Freeze / unfreeze picture (p. 13)
 - Holds the current teletext page (teletext mode) (p. 16)
- 23 Index (p. 16)**
 - Returns to the teletext index page (teletext mode)
- 24 Programme Information (p. 14)**
- 25 Channel Up / Down**
 - Selects channel in sequence
- 26 Connected equipment operations (p. 19)**

TV

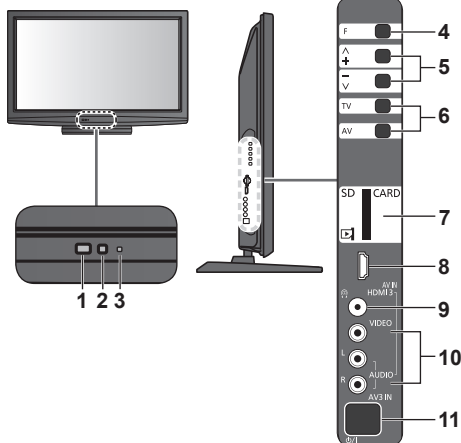

- Remote control signal receiver
 - Do not place any objects between the TV remote control signal receiver and remote control.
- C.A.T.S. (Contrast Automatic Tracking) sensor
 - Senses brightness to adjust picture quality when "Eco Mode" in the Picture Menu is set to "On" (p. 23)
- Power LED
 - Standby: red On: green
 - When using the remote control, indicates the TV has received a command.
- Function Select
 - Volume / Contrast / Brightness / Colour / Sharpness / Tint (NTSC mode) / Bass ("Music" or "Speech" mode in the Sound Menu) / Treble ("Music" or "Speech" mode in the Sound Menu) / Balance / Auto Tuning (p. 23 - 26)
- Increases or decreases the channel position by one. When a function is already displayed, press to increase or decrease the selected function. When in standby mode, switches TV on.
- Changes the input mode
- SD card slot
- HDMI3 terminal
- Headphone jack
- AV3 terminals
- Mains power On / Off switch
 - Switch On to turn on the TV or turn the TV to Standby mode by the remote control

Using the On Screen Displays

Many features available on this TV can be accessed via the On Screen Display menu.

Example (Sound Menu):

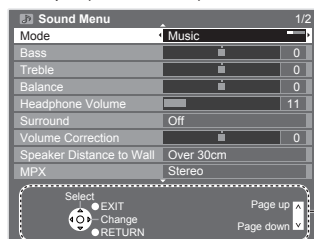

Operation guide will help you.

How to use remote control

- MENU** (square button with right arrow) Open the Main Menu
- OK** (circular button with center dot) Move the cursor / select the menu item
- Left/Right/Up/Down** (circular button with four arrows) Move the cursor / adjust levels / select from a range of options

- OK** (circular button with center dot) Access the menu / store settings after adjustments have been made or options have been set
- RETURN** (circular button with left arrow) Return to the previous menu
- EXIT** (circular button with center dot) Exit the menu system and return to the normal viewing screen

Auto Tuning

Search and store TV channels automatically.

These steps are not necessary if the setup has been completed by your local dealer.



1 Plug the TV into mains socket and switch On



- You can now use the remote control to turn On the TV or switch the TV to standby mode. (Power LED: On)

2 Select your language

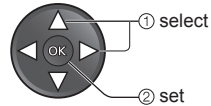

3 Select your area

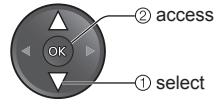

When selecting CATV / Other, press the OK button, and then select the Channel Plan from Indian CATV, South Africa, American System, American CATV or Japan.

Auto Tuning starts



- Auto Tuning will start to search for TV channels and store them. The sorted channel order depends upon the TV signal, the broadcasting system and reception conditions.

4 Select "Home"

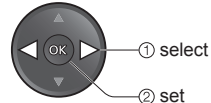
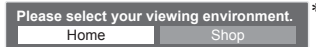

Auto Tuning is complete

*Viewing environment mode

Home : Recommended mode for viewing at home. Select "Home" for optimal picture / power consumption. "Viewing Mode" is set as "Normal" (p. 23).

Shop : Demonstration mode to explain main features of this TV (for in-store display). "Viewing Mode" is set as "Dynamic" (p. 23).

To return to viewing environment selection mode if you selected "Shop"



- To change viewing environment mode later on, reset all settings by accessing Shipping Condition. ➔ "Shipping Condition" (p. 31)

Watching TV



1 Turn power on



- Mains power On / Off switch should be On (p. 11).

2 Select TV mode



3 Select a channel

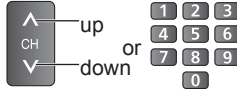

- To select the two-digit channel number, e.g. 35
→ **3** → **5** (in a short time)
- If one-digit channel number
→ **OK** → quickly changes the channel

Note

- When the TV is switched to standby, there will be a clicking sound after a short delay. This is normal.

Other useful functions

Hold

HOLD Freeze / unfreeze picture

Off Timer

Turn the TV off automatically after a fixed period of time (0 / 15 / 30 / 45 / 60 / 75 / 90 minutes)

OFF TIMER



Press repeatedly until desired time appears.

- Also possible to set the time from “Off timer” in the Setup Menu (p. 25)
- To cancel → Set to “0” or turn the TV off.
- To display the remaining time → Information banner (p. 14)
- When the remaining time is within 3 minutes, the remaining time will flash on screen.

Watching TV

Other useful functions

Display information banner



Display information banner

- Also appears when changing channels

TV	Input mode
1	Channel position
CH08	Channel number
5.5MHz	Sound system
PAL	Colour system *1
16:9	Aspect ratio

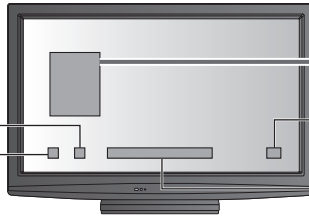

○, I, II, ▽ Audio mode (p. 41)

🔇 Sound mute On

1 - 90 Off Timer remaining time
● For settings → p. 13

Teletext
(varies depending on the broadcasters)
Teletext service available

● To hide → EXIT

*1 Colour system appears when AV Colour System is set to other than Auto.

Display the selectable settings for the current programme

OPTION

Check or change the current programme status instantly

● To change

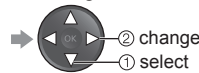

Channel Colour Set

Sets colour density → Picture Menu (p. 23)

MPX

Selects multiplex sound (if available)
→ Sound Menu (p. 24)

Teletext Character Set

Sets the teletext language → Setup Menu (p. 25)

Volume Correction

Adjusts volume of individual programme or input mode → Sound Menu (p. 24)

Change OSD language

You can change language for on screen displays.

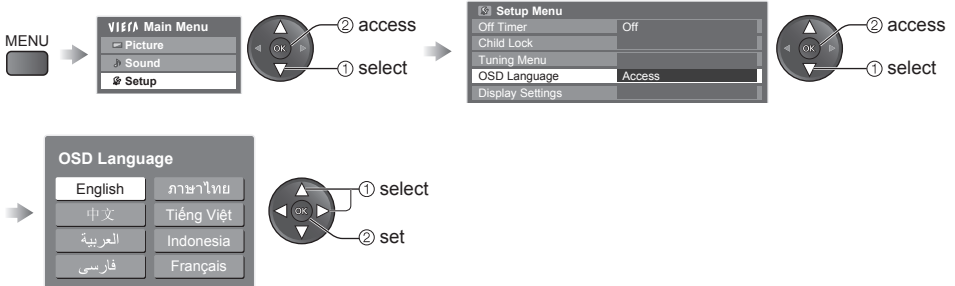

Other useful functions

Change aspect ratio

Enjoy viewing the picture at its optimum size and aspect.

ASPECT



Display Aspect Selection list

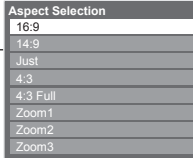

② store

① select

While the list is displayed, select the mode

To change the mode using the ASPECT button only

ASPECT



➔ Press repeatedly until you reach the desired mode

16:9



Directly displays the image at "16:9" without distortion (anamorphic).

14:9



Displays the image at the standard "14:9" without distortion.

Just



Displays a "4:3" image full-screen. Stretching is only noticeable at the left and right edges.

4:3



Displays the image at the standard "4:3" without distortion.

4:3 Full



Displays a "4:3" image enlarged horizontally to fit the screen.
● HD signal only

Zoom1



Displays a "16:9" letterbox or "4:3" image without distortion.

Zoom2



Displays a "16:9" letterbox (anamorphic) image full-screen without distortion.

Zoom3

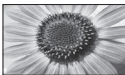

Displays a "2.35:1" letterbox (anamorphic) image full-screen without distortion. At "16:9", displays the image at its maximum (with slight enlargement).

Note

- Only "16:9" and "4:3" are available in PC input mode.
- Aspect is fixed to "16:9" when "Viewing Mode" is set to "Game" in the Picture Menu.
- Not available in teletext mode.
- Aspect mode can be memorized separately for SD (Standard definition) and HD (High definition) signals.

Viewing Teletext

Teletext services are the text information provided by the broadcasters. The features may vary depending on the broadcasters.

What is FASTEXT mode?

In FASTEXT mode, four differently coloured subjects are situated at the bottom of the screen. To access more information about one of these subjects, press the appropriately coloured button. This facility enables fast access to information on the subjects shown.

What is List mode?

In List mode, four differently coloured page numbers are situated at the bottom of the screen. Each of these numbers can be altered and stored in the TV's memory. ("Store frequently viewed pages" → p. 17)

To change mode → "Teletext" in Setup Menu (p. 25)

1 Switch to Teletext

- TEXT**
 - Displays Index (content varies depending on the broadcasters)
- F.P.**
 - Pressing this button while watching TV programme directly accesses to the favourite page stored in "blue".

2 Select the page (up to page 899)

1 2 3
4 5 6
7 8 9
0

or

up
down

or

CH

or

R G Y B
(Corresponds to the colour bar)

To adjust contrast

→ MENU (press three times) → OK As the blue bar is displayed

To return to TV → TEXT or EXIT

Current page number: **100**

Time / date: 17:51 28 Feb

TELETEXT INFORMATION

Sub page number: 0 1 2 3 4 5 6 7 8 9

Colour bar: R G Y B

Functions (Teletext mode)

Hold	Reveal hidden data
HOLD Stop automatic updating (If you wish to hold the current page without updating) To resume →	MENU → R Reveal hidden words e.g. quiz page answers To rehide → R
INDEX	Call up a favourite page
INDEX Return to the main index page	F.P. View a favourite page stored <ul style="list-style-type: none"> Call up the page stored in "blue" (List mode). Factory setting is "103".

Functions (Teletext mode)

View in multi window

Watch TV and Teletext in two windows at once

MENU (press twice) →  Select teletext only or picture / teletext



- Operations can be made only in Teletext screen.

FULL / TOP / BOTTOM

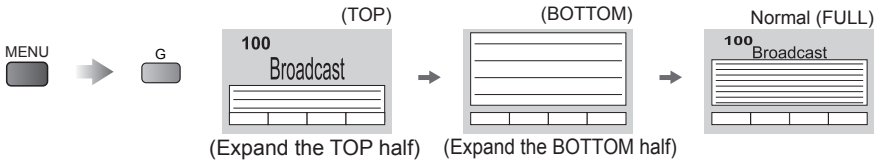

Store frequently viewed pages

Store frequently viewed pages in the colour bar (List mode only)



To change stored pages



View sub page

View sub page (Only when teletext is more than one page)

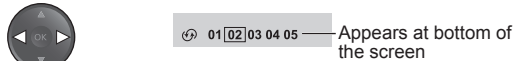

To view specific sub page

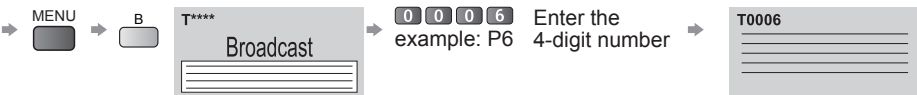

- Sub pages:
The number of sub pages varies depending on the broadcasters.
It may take some time for searching, during which time you can watch TV.

Watch TV while waiting for update

View the TV picture while searching for a teletext page

Teletext automatically updates itself when new information becomes available.



Changes to TV screen temporarily (You cannot change the programme.)

- The news page provides a function that indicates arrival of latest news ("News Flash").

Watching External inputs

Connect the external equipment (VCRs, DVD equipment, PC, etc.) and you can watch the input.

● To connect the equipment → p. 38, 39

The Remote Control is capable of operating some functions of selected external equipment.

For details, see the manual of the equipment or ask your local dealer.



1 Display the input selection menu

AV

- When viewing PC → PC (→ skip to 3)

2 Select the input mode of the connected equipment

- You can also select the input using the AV button on the remote control or the side panel of the TV (p. 11). Press the button repeatedly until the desired input is selected.
- You can label or skip each input mode → “Input Labels” (p. 30)
Skipped inputs will not be displayed when the AV button is pressed.

Example (AV2)

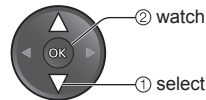
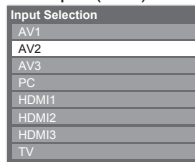

3 View

The selected mode is displayed on the screen.

Example (AV2)



- If the external equipment has an aspect adjustment function, set to “16:9”.

Example (PC)

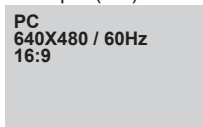









- You can also listen to PC sound with the audio cable connected. (To connect → p. 38 - 39)
- You can setup some functions in Advanced PC Settings (p. 23) in Picture Menu and PC setup (p. 25) in Setup Menu.
- For HDMI-compatible PC (p. 42 - 43), possible to connect to HDMI terminals (HDMI1 / HDMI2 / HDMI3) by using HDMI cable.

To return to TV

→ TV

Operating the equipment with the TV remote control

The equipment connected to the TV can be directly operated with the below buttons of this TV remote control.

	Standby Set to Standby mode / Turn on
	Play Playback videocassette / DVD
	Stop Stop the operations
	Rewind / Skip / Search VCR: Rewind, view the picture rapidly in reverse DVD: Skip to the previous track or title Press and hold to search backward
	Fast-forward / Skip / Search VCR: Fast-forward, view the picture rapidly forward DVD: Skip to the next track or title Press and hold to search forward
	Pause Pause / Resume DVD: Press and hold to play at slow speed
	Programme Up / Down Select programme
	Record Start recording



How to change the code for each equipment

Each type of Panasonic equipment has its own remote control code.

Please change the code for each equipment you want to operate.

If you operate the connected equipment in VIERA Link (p. 34), select the code "73".

Press and hold  during the following operations

Enter the appropriate code (see table below)  → Press 

Type of equipment	Code
DVD Recorder / DVD Player	70 (default)
Player theatre / Blu-ray Disc theatre	71
VCR	72
The equipment using in VIERA Link → "VIERA Link Control" (p. 36)	73

Note

- Confirm if the remote control works correctly after changing the code.
- The codes may be reset to default values if batteries are replaced.
- Some operations may not be possible on some equipment models.

How to Use VIERA TOOLS

You can access some special features easily by using the VIERA TOOLS function.

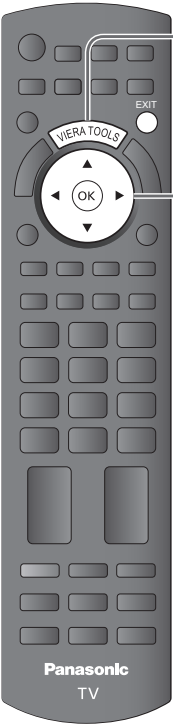

1 Display icons of the feature



2 Select a feature

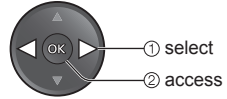
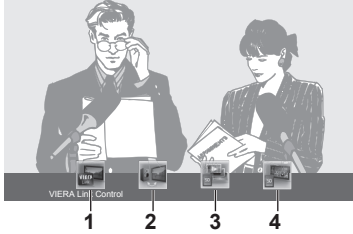

3 Follow the operation of each feature

1 VIERA Link Control → "VIERA Link Control" (p. 36)



When two or more compatible equipments are connected, a selection screen will be displayed.
Please select the correct description and access.

2 Speaker Selection → "Speaker Selection" (p. 37)



3 Slideshow → "Slideshow" (p. 33)



4 Photos → "Photo View" (p. 32)



To return to TV



How to Use Menu Functions

Various menus allow you to make settings for the picture, sound, and other functions.

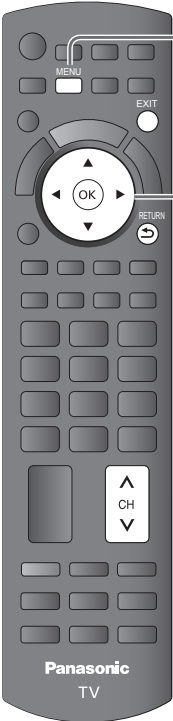

1 Display the menu



- Displays the functions that can be set (varies according to the input signal)

2 Select the menu

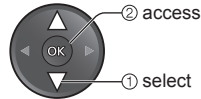

3 Select the item

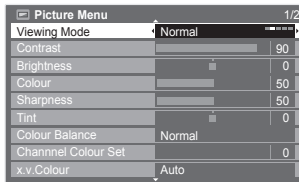

4 Adjust or select

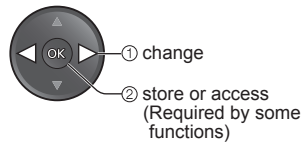
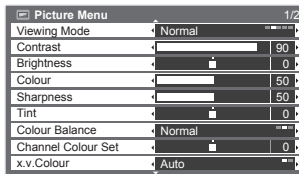

To return to TV at any time



To return to the previous screen



To change menu pages

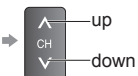

Choose from among alternatives

Number and positions of alternatives

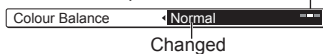

Adjust using the slide bar

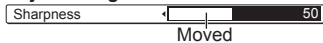

Go to the next screen

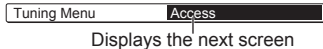

To reset the settings

- To reset the picture settings only
➔ "Reset to Defaults" in Picture Menu (p. 23)
- To reset the sound settings only
➔ "Reset to Defaults" in Sound Menu (p. 24)
- To reset all settings
➔ "Shipping Condition" (p. 31) in Setup Menu

VIERA Main Menu

Picture

Sound

Setup

Picture (p. 23)

Picture Menu 1/2	
Viewing Mode	Normal
Contrast	90
Brightness	0
Colour	50
Sharpness	50
Tint	0
Colour Balance	Normal
Channel Colour Set	0
x.v.Colour	Auto

Picture Menu 2/2	
Eco Mode	Off
P-NR	Off
3D-COMB	On
Advanced PC Settings	Access
Reset to Defaults	Reset

Sound (p. 24)

Sound Menu 1/2	
Mode	Music
Bass	0
Treble	0
Equalizer	Access
Balance	0
Headphone Volume	12
Surround	Off
Volume Correction	0
Speaker Distance to Wall	Over 30cm

Sound Menu 2/2	
MPX	Stereo
HDMI1 Input	Digital
Reset to Defaults	Reset

Setup (p. 25, 26)

Setup Menu	
PC Setup	Access
Off Timer	Off
Child Lock	Access
Tuning Menu	Access
OSD Language	Access
Display Settings	Access
VIERA Link Settings	Access
System Menu	Access
Other Settings	Access

Tuning Menu	
Channel List Edit	Access
Auto Tuning	Access
Manual Tuning	Access

(p. 25)

Display Settings	
Teletext	FASTEXT
Teletext Character Set	English
Side Panel	Off
Input Labels	Access
Playing Time Display	On

(p. 25)

VIERA Link Settings	
VIERA Link	On
Power on Link	Off
Power off Link	On
Standby Power Save	Off
Intelligent Auto Standby	Off

(p. 26)

System Menu	
Shipping Condition	Access
Software Licence	Access
System Information	Access

(p. 26)

Other Settings	
AV Colour System	Auto
Colour Matrix	SD
Auto Standby	Off
Power Save	Off
16:9 Overscan	On
Refresh Rate	100Hz



(p. 26)

● Depending on the received signals, available items are varied.

Menu list

Menu	Item	Adjustments / Configurations (alternatives)
Picture	Viewing Mode	<p>Basic picture mode (Dynamic / Normal / Cinema / Game) In each Viewing Mode, Contrast, Brightness, Colour, Sharpness, Tint, Colour Balance, x.v.Colour, Eco Mode, P-NR and 3D-COMB can be adjusted and stored to suit your particular viewing requirement.</p> <ul style="list-style-type: none"> ● Set for each input signal. <p>Dynamic : Provides enhanced picture contrast and sharpness when viewing in a bright room</p> <p>Normal : Recommended for viewing under normal ambient room lighting conditions.</p> <p>Cinema : For watching movies in a darkened room with improving the performance of contrast, black and colour reproduction</p> <p>Game : Fast response signal specifically to provide suitable images for playing games</p> <ul style="list-style-type: none"> ● Not valid on TV mode ● A continuous record of time spent using Game mode can be displayed in the top right of the screen. ➔ "Playing Time Display" (p. 25)
	Contrast, Brightness, Colour, Sharpness	Increases or decreases the levels of these options according to your personal preference
	Tint	<p>With an NTSC signal source connected to the TV, the picture hue can be adjusted to suit your taste.</p> <ul style="list-style-type: none"> ● For NTSC or Component / HDMI input signal reception only
	Colour Balance	Allows you to set the overall colour tone of the picture (Cool / Normal / Warm)
	Channel Colour Set	<p>Colour density varying between broadcast channels can be adjusted to three levels for each reception channel</p> <ul style="list-style-type: none"> ● Select the channel you want to adjust and set this function.
	x.v.Colour	<p>Increases the colour gradations (Off / Auto) This is effective when watching HD moving pictures with extended gamut (xvYCC) from external equipment.</p> <ul style="list-style-type: none"> ● HDMI input mode only
	Eco Mode	<p>Automatically adjusts the screen brightness appropriately as the surrounding light level lowers to reduce the power consumption (Off / On)</p> <ul style="list-style-type: none"> ● Not available in Shop mode (Dynamic picture mode)
	P-NR	<p>Picture Noise Reduction Automatically reduces unwanted picture noise and flicker noise in the contoured parts of a picture (Off / Min / Mid / Max)</p> <ul style="list-style-type: none"> ● Not valid on PC signal
	3D-COMB	<p>Makes still or slow moving pictures look more vivid (Off / On)</p> <ul style="list-style-type: none"> ● Occasionally, while viewing still or slow moving pictures, colour patterning may be seen. Set to "On" to display sharper and more accurate colours. ● For PAL or NTSC signal reception only ● Not valid on Component, PC, HDMI and SD Card
	Advanced PC Settings	W/B High R
W/B High B		White balance of bright blue area
W/B Low R		White balance of dark red area
W/B Low B		White balance of dark blue area
Gamma		Changes the gamma curve (S curve / 2.0 / 2.2 / 2.5)
	Reset to Defaults	Press the OK button to reset the present Advanced PC Settings to the default.
	Reset to Defaults	Press the OK button to reset the present Picture Menu settings to the default.

Menu	Item	Adjustments / Configurations (alternatives)
Sound	Mode	<p>Selects basic sound mode (Music / Speech / User)</p> <ul style="list-style-type: none"> ● The selected mode affects all input signals. <p>Music : Improves sound quality for watching music video, etc. Speech : Improves sound quality for watching news, drama, etc.</p> <ul style="list-style-type: none"> ● In Music and Speech mode, you can adjust “Bass” and “Treble” settings, and those settings will be stored for each mode. <p>User : Adjusts the sounds manually by using the equalizer to suit your favourite sound quality.</p> <ul style="list-style-type: none"> ● For the User mode, “Equalizer” will appear on the Sound Menu instead of “Bass” and “Treble”. Select the “Equalizer” and adjust the frequency. ➔ “Equalizer” (below)
	Bass	Increases or decreases level to enhance or minimise lower, deeper sound output
	Treble	Increases or decreases level to enhance or minimise sharper, higher sound output
	Equalizer	<p>Adjusts the frequency level to suit your favourite sound quality</p> <ul style="list-style-type: none"> ● This function is available when “Mode” is set to “User”. ● Select the frequency and change the frequency level by using the cursor button. ● If you want to enhance the bass sound, raise the level of the lower frequency. If you want to enhance the treble sound, raise the level of the higher frequency. ● To reset the levels of each frequency to the default settings, select the “Reset to Defaults” by using cursor button, and then press the OK button.
	Balance	Adjusts the volume level of right and left speakers
	Headphone Volume	Adjusts the volume of the headphones
	Surround	<p>Surround sound settings (Off / V-Audio)</p> <p>V-Audio: Provides a dynamic enhancer of width to simulate improved spatial effects</p> <ul style="list-style-type: none"> ● Switching is also possible by the Surround button on the remote control (p. 10).
	Volume Correction	Adjusts the volume of individual channel or input mode
	Speaker Distance to Wall	<p>Adjusts the low frequency sound (Over 30cm / Up to 30cm)</p> <ul style="list-style-type: none"> ● If the back space between the TV and wall is over 30 cm, “Over 30cm” is recommended. ● If the back space between the TV and wall is within 30 cm, “Up to 30cm” is recommended.
	MPX	<p>Selects multiplex sound mode (if available) (p. 41)</p> <ul style="list-style-type: none"> ● Normally : Stereo ● Stereo signal cannot be received: Mono ● M1 / M2 : Available while mono signal is transmitted
HDMI1 / 2 / 3 Input	<p>Select to fit the input signal (Digital / Analogue) (p. 42).</p> <p>Digital: HDMI cable connection Analogue: HDMI-DVI adapter cable connection</p> <ul style="list-style-type: none"> ● HDMI input mode only 	
Reset to Defaults	Press the OK button to reset the present settings of Mode, Balance, Headphone Volume, and Surround in Sound Menu to the default.	

Menu	Item	Adjustments / Configurations (alternatives)
Setup	PC Setup	Input Resolution Switches to a wide view ● VGA (640 × 480 pixels), WVGA (852 × 480 pixels), XGA (1,024 × 768 pixels), WXGA (1,280 × 768 pixels, 1,366 × 768 pixels) ● Options change depending on signals
		Clock Set to the minimum level if noise occurs.
		H-pos Adjusts horizontal position 
		V-pos Adjusts vertical position 
		Clock Phase Eliminates flicker and distortion ● Adjust after Clock adjustment ● Set to the minimum level if noise occurs
		Sync PC sync signal type (H & V / On Green) H & V : by the horizontal and vertical signals from your PC On Green : by green signal from your PC
		Reset to Defaults Press the OK button to reset the present PC Setup settings to the default.
	Tuning Menu	Off Timer Sets the time the TV automatically goes to Standby mode (Off / 15 / 30 / 45 / 60 / 75 / 90 minutes) (p. 13)
		Child Lock Locks a channel / AV input to prevent access to it (p. 29)
		Channel List Edit Skips the unwanted channels (p. 28)
Display Settings	Auto Tuning Sets all TV channels automatically (p. 28)	
	Manual Tuning Sets the TV channels manually (p. 28)	
	OSD Language Changes language for on screen displays (English / Thai / Chinese / Vietnamese / Arabic / Indonesia / Persian / French)	
	Teletext Teletext display mode (FASTTEXT / List) (p. 16)	
	Teletext Character Set Selects teletext language (English / CIS / E.Europe / Persian)	
Display Settings	Side Panel Increases the brightness of the side panel (Off / Low / Mid / High) ● The recommended setting is "High" to prevent panel "image retention".	
	Input Labels Labels or skips each input terminal (p. 30)	
	Playing Time Display Set to "On" to display a continuous record of time spent using Game mode every 30 mins (Off / On) ● This function is available when "Game" is selected in "Viewing Mode" (p. 23).	

Menu	Item	Adjustments / Configurations (alternatives)
Setup	VIERA Link Settings	VIERA Link Sets to use VIERA Link functions (Off / On) ● VIERA Link functions become available when “VIERA Link” is set to “On” (p. 36).
		Power on Link Sets to use Power on Link functions (Off / On) (p. 35)
		Power off Link Sets to use Power off Link functions (Off / On) (p. 35)
		Standby Power Save Controls the power consumption in Standby mode of the connected equipment to reduce the consumption (Off / On) (p. 35) ● This function is available when “VIERA Link” is set to “On” and “Power off Link” is set to “On”.
		Intelligent Auto Standby Makes non-watched or non-used connected equipment go into Standby mode to reduce the power consumption (Off / On (With reminder) / On (No reminder)) (p. 35) ● This function is available when “VIERA Link” is set to “On”.
	System Menu	Shipping Condition Resets all settings to the original condition (p. 31)
		Software Licence Displays the software licence information
		System Information Displays the system information of this TV
	Other Settings	AV Colour System Selects optimum colour system based on video signals in AV mode (Auto / PAL / SECAM / M.NTSC / NTSC)
		Colour Matrix Available only with 480p or 576p input on video signals in a natural colour from digital equipment connected to AV1 component or HDMI1 / HDMI2 / HDMI3 terminals. Select SD or HD to adjust suitable colour parameters for SD (standard definition) or HD (high definition) ● SD: Input signal is a normal TV system ● HD: Input signal is a high definition system
		Auto Standby Sets the time the TV automatically goes to Standby mode when no operation is performed for the selected times (Off / 2 hours / 4 hours) ● Inserting the SD Card to the card slot does not affect this function. ● Automatic input switching with the connected equipment affects this function and time-count will be reset. ● The notification message will appear 3 minutes before going to Standby mode.
		Power Save Reduces brightness of picture to economise on power consumption (Off / On)
		16:9 Overscan Selects the screen area for displaying the image (Off / On) On: Enlarges the image to hide the edge of the image Off: Displays the image in the original size ● Set to “On” if noise is generated on the edges of the screen. ● This function is available when aspect is set to “16:9”. ● This function can be memorized separately for SD (Standard Definition) and HD (High Definition) signals.
		Refresh Rate Changes the image processing of the panel (depending on the input signal) (50Hz / 100Hz) ● Set to “100Hz” normally.

- A different menu will be displayed in the mode of SD Card (p. 32 - 33).
- Only available items can be selected.

Tuning and Editing Channels

You can retune all the TV channels when moving house.



1 Select TV mode



2 Display the menu

MENU



3 Select "Setup"

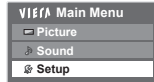

4 Select "Tuning Menu"

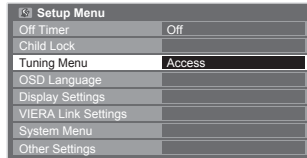

5 Select a function

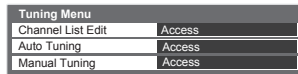

6 Set (see next page)

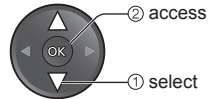
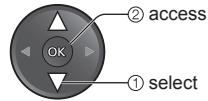
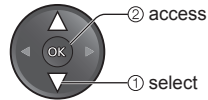

To return to TV



Tuning and Editing Channels

Channel List Edit Skip unwanted channels

Select a channel and reveal / hide

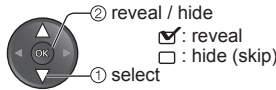
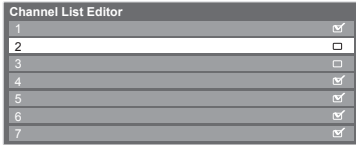

● To reveal all channels →

You can hide unwanted channels. The hidden channels cannot be displayed except in this function. Use this function to skip unwanted channels.

Auto Tuning Set all TV channels automatically

Start Auto Tuning

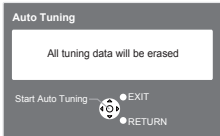

Settings are made automatically



Automatically retune all channels received in the area.

- All the previous tuning settings are erased.
- When the operation is completed, the channel at channel position "1" will be displayed.
- Search begins in the order from the lower channels to the higher channels. Channels received during this process are added to the list (see above).
- If tuning has not been done completely → "Manual Tuning" (see below)

For Auto Tuning, using the buttons on the side panel of the TV (p. 11)

- ① Press repeatedly until "Auto Tuning" appears
 - ② Access "Auto Tuning" TV
 - ③ Start "Auto Tuning" TV
- To return to TV →

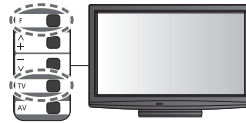

Manual Tuning Set channel manually

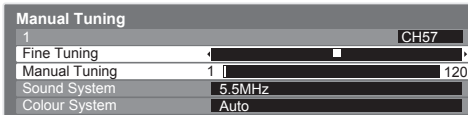

Fine Tuning

- Use to make small adjustments to the tuning of an individual channel (affected by weather conditions, etc.)

Manual Tuning

- Set channel manually after Auto Tuning.
- Set Sound System and Colour System, and then perform this function. Set Colour System "Auto" normally.
 - If a VCR is connected only with the RF cable, select channel position "0".

Select a channel position



Select a channel



Search and store

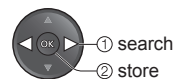

Child Lock

You can lock specific channels / AV input terminals and control who watches them. When the locked channel / input is selected, a message appears; by entering the PIN number, you can watch it.

- 1 Display the menu**
MENU
- 2 Select "Setup"**
VIERA Main Menu
Picture
Sound
Setup
- 3 Select "Child Lock"**
Setup Menu
Off Timer Off
Child Lock Access
Tuning Menu
OSD Language
Display Settings
VIERA Link Settings
System Menu
Other Settings
- 4 Set (see below)**

To return to TV



Child Lock Control channel audience

- 1 Enter the PIN number (4 digits)**
Child Lock-PIN Entry
Please enter new PIN
PIN * * * *
1 2 3
4 5 6
7 8 9
0
 - Enter the PIN number twice at first setting.
 - Make a note of the PIN number in case you forget it.
- 2 Select "Child Lock List"**
Child Lock
Change PIN
Child Lock List Access
 - To cancel
➔ Select the locked channel / input
➔ OK
 - To lock all ➔ G
 - To cancel all locks ➔ Y
- 3 Select the channel / input to be locked**
Child Lock List - TV and AV

Name	Lock
2	🔒
3	🔒
AV1	🔒
AV2	🔒
AV3	🔒
PC	🔒
HDMI1	🔒
HDMI2	🔒

Appears when the channel / input is locked

To change the PIN number

Select "Change PIN" in "Child Lock" and enter a new PIN number twice.

Note

- Performing "Shipping Condition" (p. 31) erases the PIN number and all settings.

Input Labels

For easier identification and selection of the input mode, you can label each input terminals or skip terminal that is not connected to any equipment.

- To select the input mode → p. 18



1 Display the menu



2 Select "Setup"

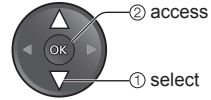
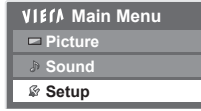

3 Select "Display Settings"

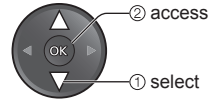
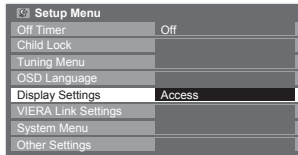

4 Select "Input Labels"

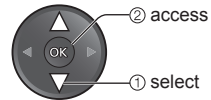
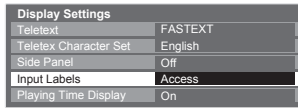

5 Select an input terminal and set

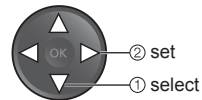
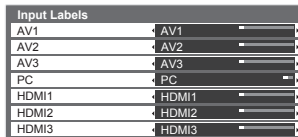

To return to TV



The labels you set will be displayed in "Input Selection" menu (p. 18) or banner.

- If "Skip" is selected, you cannot select the mode.

Shipping Condition (Reset settings)

Resets the TV to its original condition, i.e. no channels tuned in. All settings are reset (channels, picture, sound settings, etc.).



1 Display the menu



2 Select "Setup"

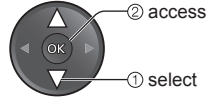
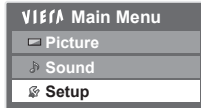

3 Select "System Menu"

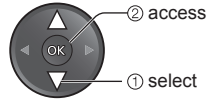
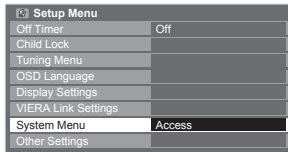

4 Select "Shipping Condition"

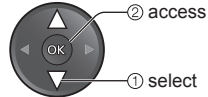

5 Set (see below)

To return to TV



Shipping Condition Reset Settings

① Check the message and reset

Shipping Condition
All tuning data will be erased
Are you sure?
Are you sure?

Confirm

EXIT

RETURN

OK (confirm)

OK (confirm)

OK (start Shipping Condition)

② Follow the on screen instructions

Reset to Factory Shipping Condition Completed.
Please switch off TV.

- "Auto Tuning" will automatically start when Mains power On / Off switch is next turned On (p. 12).

To retune TV channels only, e.g. after moving house

➔ "Auto Tuning" in "Tuning and Editing Channels" (p. 28)

Viewing from SD Card

(VIERA IMAGE VIEWER)

Still images recorded by digital cameras will be displayed.

- During the operation, no signals are output from any of the AV terminals.
- "Date" shows the date on which the recording was made by the digital camera. The file without record of the date is shown "****/*/*".
- For details on SD Cards → p. 44

To insert SD Card
Gently insert the SD Card label surface facing front.

Push until a click is heard

To remove SD Card
Push the centre of the card

Photo View



1 Insert the SD Card

2 Select "Photo View"

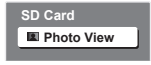

OK — access

3 Select a folder to display the thumbnail

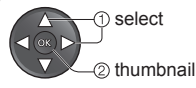
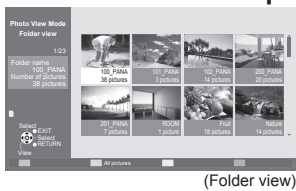

- The files which are not in a folder will be collected to the folder named "/*".
- To display all the photos → p. 33

4 Select a photo from the thumbnail to be viewed

Selected photo (images that could not be loaded, etc.)

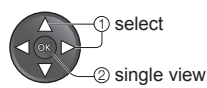
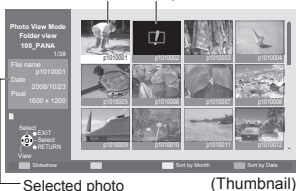

- Slideshow → p. 33
- To sort by date or month recorded → p. 33

To return to TV
EXIT or SD CARD

To return to the previous screen
RETURN

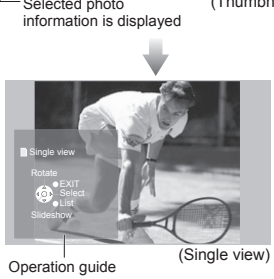

Displayed one at a time
● To display / hide the operation guide

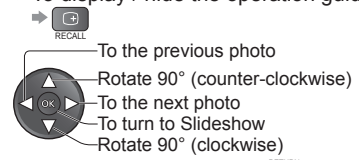

- To return to thumbnail → RETURN

Slideshow

Start Slideshow (operate in step 4)

Select the photo for the first view

Start Slideshow



Note

- Slideshow is done within the thumbnail.

Slideshow settings (operate in Photo View Mode)

Display the menu

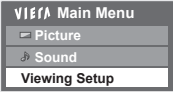

● Picture and Sound Menu
→ p. 23 - p. 24

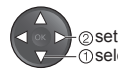
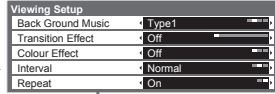

● set
● select

Menu	Item	Adjustments / Configurations (alternatives)
Viewing Setup	Back Ground Music	Selects the background music played during Photo View (Off / Type1 / Type2 / Type3)
	Transition Effect	Selects the transition effect used when switching between photos during the slideshow (Off / Wipe ↓ / Wipe ↑ / Wipe → / Wipe ← / Comb ↑↓ / Comb ↔ / Dissolve / Checker wipe / Random / Multi / Collage) Wipe : The next photo wipes in the arrow direction. Comb : The next photo wipes comb-likely in the arrow direction. Dissolve : The photo is replaced by an indefinite block unit. Checker wipe : The next photo wipes like checkered flag. Random : Each transition such as Wipe, Comb, Dissolve or Checker wipe is selected at random. Multi : Display is divided into 9 sections in a tiled design Collage : Photos are displayed in random positions and random scale
	Colour Effect	Selects the colour effect of photos (Off / Sepia / Gray scale)
	Interval	Selects slideshow interval (Short / Normal / Long)
	Repeat	Slideshow repeat (Off / On)

To display all the photos

Display the thumbnail of all the photos in SD Card.



(Folder view)

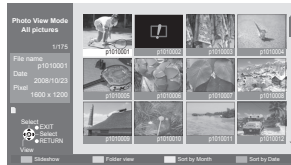

(Thumbnail - All pictures)

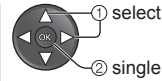

● select
● single view

To sort by date or month recorded

Display the list of groups sorted by the same date or the same month.

- The group of the photos without record of the date is shown as "Unknown".

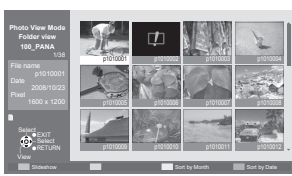

(Thumbnail)

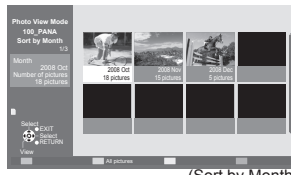

(Sort by Month)

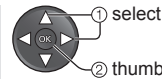

● select
● thumbnail of the selected group

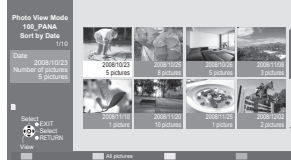

(Sort by Date)

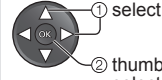

● select
● thumbnail of the selected group

VIERA Link Functions

VIERA Link "HDAVI Control™"

Enjoy additional HDMI interoperability with Panasonic products which have "HDAVI Control" function. This TV supports "HDAVI Control 5" function.

Connections to the equipment with HDMI cable such as DIGA Recorder, HD Video Camera, Player theatre, Amplifier, etc., allow you to interface them automatically.

- Some functions are not available depending on the equipment's version of HDAVI Control. Please confirm the connected equipment's version of HDAVI Control.
- VIERA Link "HDAVI Control", based on the control functions provided by HDMI which is an industry standard known as HDMI CEC (Consumer Electronics Control), is a unique function that we have developed and added. As such, its operation with other manufacturers' equipment that supports HDMI CEC cannot be guaranteed.
- Please refer to individual manuals for the equipments. About applicable Panasonic equipment, consult your local Panasonic dealer.

Summary of features

Features	Connected equipment with VIERA Link function					
	DIGA Recorder*1	DVD Player / Blu-ray Disc Player*1	HD Video Camera / LUMIX Camera*1	Player theatre*2	Blu-ray Disc theatre*2	Amplifier*2
Easy playback	○	○	○	○*5	○*5	—
Power on link	○	○	○	○	○	—
Power off link	○	○	○	○	○	○
Reduce unnecessary power consumption in standby	○*4	○*4	—	—	○*4	—
Auto standby for unnecessary equipment	○*3	○*3	—	○*3*6	○*3*6	○*3
Control the menu of the connected equipment by VIERA remote control	○*3	○*3	○*3	○*3	○*3	—
Speaker control	—	—	—	○	○	○

*1: HDMI Connection only

*2: HDMI and Audio out connections

*3: available with the equipment which has "HDAVI Control 2 or later" function

*4: available with the equipment which has "HDAVI Control 4 or later" function

*5: while playback a disc

*6: except for watching a disc

Connection

- To use DIGA Recorder / DVD Player / Blu-ray Disc Player / HD Video Camera / LUMIX Camera



- To use Player theatre / Blu-ray Disc theatre:

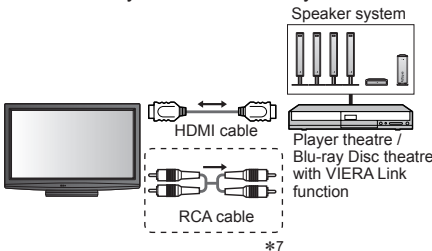

- To use Amplifier:

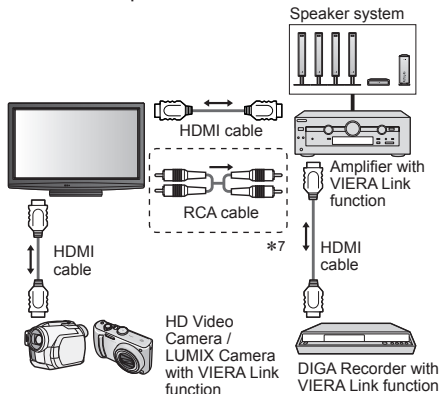

*7: If the connected equipment has "HDAVI Control 5" function, you do not have to use the RCA cable. In this case, connect the equipment to the TV's HDMI2 terminal via an HDMI cable.

Note

- This function may not work properly depending on the connected equipment.
- For DIGA Recorder / DVD Player / Blu-ray Disc Player / HD Video Camera / LUMIX Camera with VIERA Link function, connect to HDMI1, HDMI2 or HDMI3 terminal via an HDMI cable.
- For Player theatre / Blu-ray Disc theatre / Amplifier, connect to HDMI1, HDMI2, or HDMI3 terminal via an HDMI cable and/or RCA cable for audio output from the TV.
- Use fully wired HDMI compliant cable. Non-HDMI-compliant cables cannot be utilized.
Recommended Panasonic's HDMI cable part number:
 - RP-CDHS15 (1.5 m)
 - RP-CDHS30 (3.0 m)
 - RP-CDHS50 (5.0 m)

Preparations

- Connect the equipment supporting VIERA Link.
- Set up the connected equipment. Read the manual of the equipment.
- For optimal recording, the settings of the recorder might be required. For details, read the manual of the recorder.
- Set VIERA Link On in Setup Menu ➔ "VIERA Link" (p. 26)
- Set up the TV ➔ **After connection, turn the equipment on and then switch the TV on. Set the input mode to HDMI1, HDMI2 or HDMI3 (p. 18), and make sure that an image is displayed correctly.**
This setup should be done each time when the following conditions occur:
 - for the first time
 - when adding or reconnecting equipment
 - when changing setup

Features available

Easy playback

Automatic input switching - When the connected equipment is operated, input mode is switched automatically.

Power on link

Set Power on Link "On" in Setup Menu to use this function ➔ "Power on Link" (p. 26)
When the connected equipment starts playback or direct navigator / function menu for the equipment are activated, the TV is automatically turned on. (Only when the TV is in Standby mode.)

Power off link

Set Power off Link "On" in Setup Menu to use this function ➔ "Power off Link" (p. 26)
When the TV is set to Standby mode, the connected equipment is also automatically set to Standby.

- This function will work even if the TV enters standby mode automatically by Off Timer function or auto power standby function.

Standby Power Save Reduce unnecessary power consumption in standby

Set Standby Power Save "On" in the Setup Menu to use this function

➔ "Standby Power Save" (p. 26)
The power consumption in Standby mode of the connected equipment is controlled higher or lower in synchronization with the TV On / Off state to reduce the consumption.
When the TV is set to Standby mode, the connected equipment is automatically set to Standby and the power consumption in Standby mode of the connected equipment is automatically minimized.
When the TV is turned on, the connected equipment is still in Standby mode, but the power consumption is increased to make startup time early.

- This function is effective if the connected equipment can change the power consumption in Standby mode and is set to higher consumption.
- This function will work when "Power off Link" is set to "On".

Intelligent Auto Standby Auto standby for unnecessary equipment

Set Intelligent Auto Standby "On (With reminder)" or "On (No reminder)" in the Setup Menu to use this function ➔ "Intelligent Auto Standby" (p. 26)

When the TV is On, non-watched or non-used connected equipment goes into Standby mode automatically to reduce the power consumption. For example, when the input mode is switched from HDMI, when Speaker Selection is changed to "TV" (except for watching a disc).

- If you select "On (With reminder)", the on screen message will be displayed to be noticed before working this function.
- This function may not work properly depending on the connected equipment. If required, set to "Off".

VIERA Link “HDAVI Control™”

Features available (Using VIERA Link Menu)

VIERA Link Control Operate the connected equipment with VIERA remote control

Access and operate the menu of the equipment

You can control some functions of the connected equipment with this TV remote control by pointing at the TV's signal receiver.

- If you cannot operate, check the settings and the equipment
 - ➔ “Summary of features”, “Connection”, “Preparations” (p. 34, 35)
- For details of the operations for the connected equipment, read the manual of the equipment.

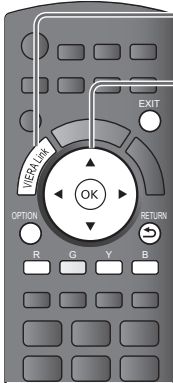

① Display “VIERA Link Menu”

② Select “VIERA Link Control”

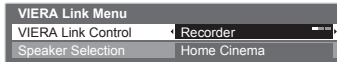

③ Select the equipment you want to access

The type of the connected equipment is displayed. Select the type of the equipment and access.

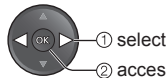

Recorder / Player / Home Cinema / Video Camera / LUMIX / Digital Camera / Other

- You can also access VIERA Link control by using VIERA TOOLS. ➔ p. 20
- The displayed item may vary depending on the connected equipment.
- “Home Cinema” means Player theatre, Blu-ray Disc theatre or Recorder theatre.
- “Other” means Tuner set top box.

↓

The menu of the accessed equipment
(Input mode will be changed automatically)

④ Operate the connected equipment

1. Set the remote control code to “73” (p. 19)
2. Follow the operation guide

To display the operation guide ➔

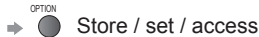

Move the cursor / select the menu ➔

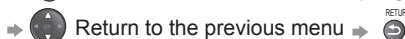

Move the cursor / access / adjust ➔

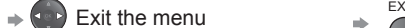

When the key words are displayed on colour bar ➔



Note

- Some operations may not be available depending on the equipment. If so, use its own remote control.

If multiple recorders or players are connected



Recorder1-3 /
Player1-3

The number is given from the TV's lower HDMI terminal number connected to the same type equipment. For example, two recorders to HDMI2 and HDMI3, in this case the recorder connected to HDMI2 is displayed as “Recorder1”, and the recorder connected to HDMI3 is displayed as “Recorder2”.

If you access non-VIERA Link equipment



Type of the connected equipment is displayed.

You can access the menu of the equipment. But you cannot operate it. Use its own remote control to operate the equipment.

Features available (Using VIERA Link Menu)

Speaker Selection Speaker control

Access and control the speaker volume

You can control the theatre speaker with this TV remote control by pointing at the TV's signal receiver.

- If you cannot operate, check the settings and the equipment
➔ "Summary of features", "Connection", "Preparations" (p. 34, 35)



① Display "VIERA Link Menu"



② Select "Speaker Selection"



select

③ Set to "Home Cinema" or "TV"



set

Home Cinema

Player theatre, Blu-ray Disc theatre or Amplifier will be automatically turned on if it is in Standby mode and the sound is from theatre speakers connected to the equipment.

- Volume up / down



- Mute ➔ 

- The sound of TV speakers is mute.
- When the equipment is turned off, TV speakers will be active.

TV

TV speakers are active.

Note

- If you wish to enjoy the multi-channel sound via an Amplifier, connect with HDMI cable (p. 34), and then select "Home Cinema". If your Amplifier has "HDAVI Control 5" function, you can connect only with HDMI cable. In this case, connect your Amplifier to the TV's HDMI2 terminal. To enjoy the sound from the DIGA Recorder in multi-channel sound, connect an HDMI cable from the DIGA Recorder to the Amplifier (p. 34).

Note

- These functions may not work properly depending on the connected equipment.
- Image or sound may not be available for the first few seconds when input mode is switched.
- Easy playback may be available by using the remote control for Player theatre, Blu-ray Disc theatre or Amplifier. Read the manual of the equipment.
- "HDAVI Control 5" is the newest standard (current as of December, 2009) for HDAVI Control compatible equipment. This standard is compatible with conventional HDAVI equipment.
- To confirm this TV's version of HDAVI Control ➔ "System Information" (p. 26)

External Equipment

These diagrams show our recommendations for how to connect the TV to your various equipment. For other connections, consult the instructions for each piece of equipment, the table below, and the specifications (p. 47).

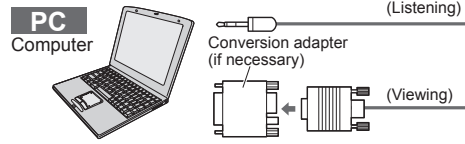
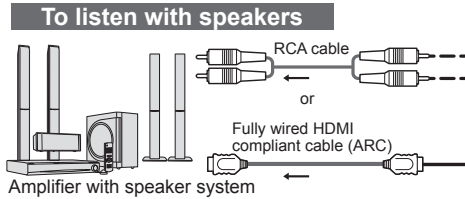
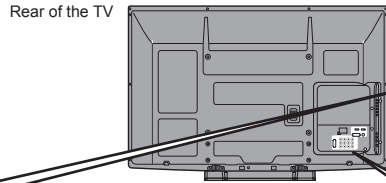
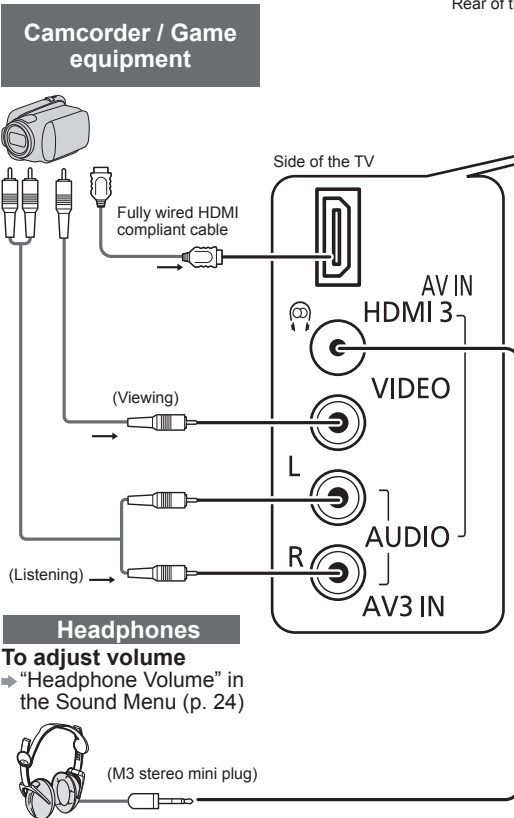

Types of connectable equipment to each terminal

Terminal	AV1 IN AV2 IN AV3 IN (Side of theTV)	MONITOR OUT	HDMI		
			1	2	3
Recording / Playback (equipment)					
To record / playback videocassettes / DVDs (VCR / DVD recorder)	○	○			
To watch DVDs (DVD player)	○		○	○	○
To watch camcorder images (Video camera)	○		○	○	○
To watch satellite broadcasts (Set top box)	○		○	○	○
To play games (Game equipment)	○		○	○	○
To use amplifier with speaker system		○		○*1	
VIERA Link			○	○	○

38 ○: Recommended Connection
*1: applicable if your amplifier has ARC (Audio Return Channel) function

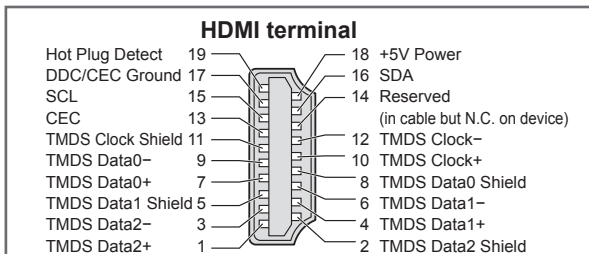
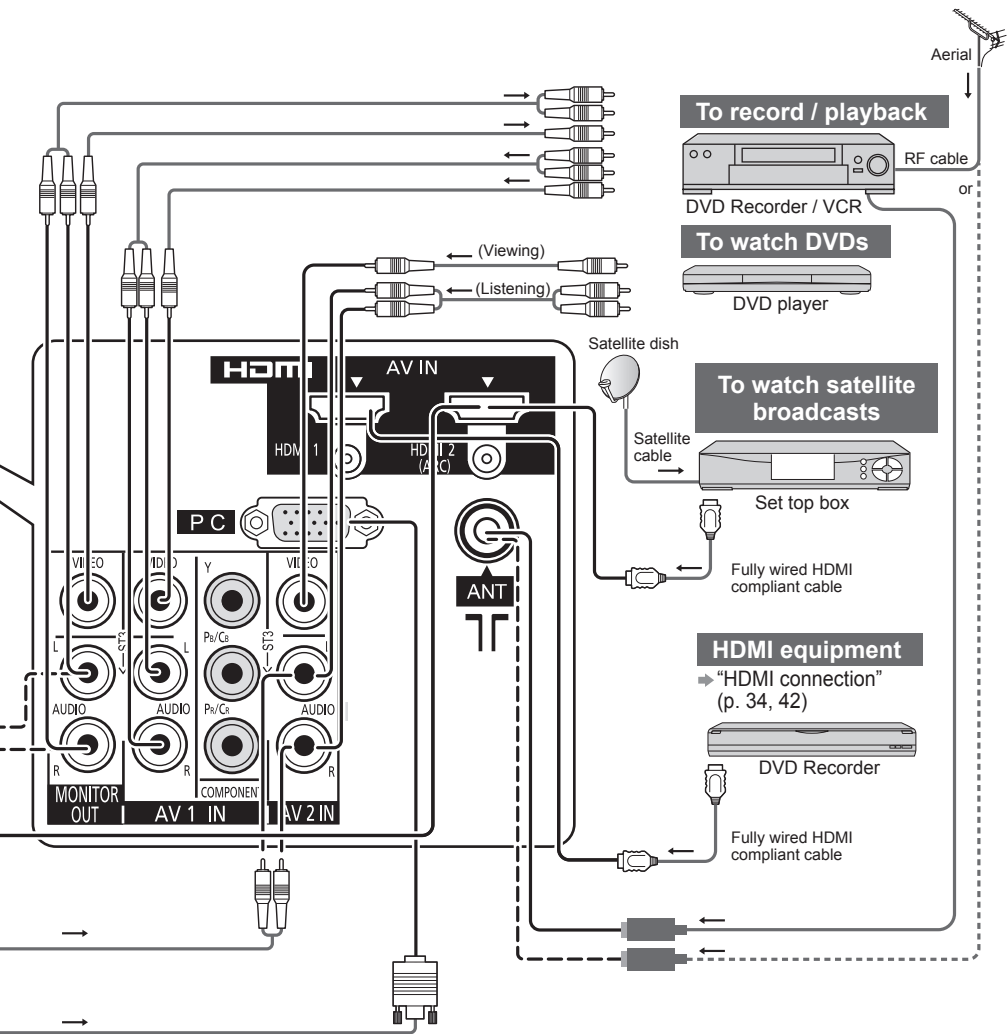

Technical Information

Channel Allocation

Channel Plan	Asia/W. Europe	CIS / E.Europe	China	Hong Kong	NZ / Indonesia	Indian CATV	South Africa	American System	American CATV	Japan	
CH DISPLAY	Receive channel										
0	-	-	-	-	-	-	-	-	-	-	
1	-	1	1	-	1	1	1	-	1	1	
2	2	2	2	-	2	2	2	2	2	2	
3	}	}	}	}	}	}	}	}	}	}	
4											
5											
6											
7											
8											
9											
10											
11											
12											
13	-	-	13	-	-	S4	13	-	-	12	
14	-	-	-	-	-	-	-	14	-	13	
15	-	-	-	-	-	-	-	-	-	-	
16	-	-	-	-	-	-	-	-	-	-	
19	-	-	-	-	-	S10	-	-	-	-	
20	-	-	-	-	-	5	-	-	-	-	
21	21	21	}	21	21	6	21	-	-	-	
22	}	}		}	}	}	}	}	}	}	}
23											
24											
25											
26											
27											
28											
29											
30											
31											
32	-	-	-	-	-	12	-	-	-	-	
33	-	-	-	-	-	S11	-	-	-	-	
34	-	-	-	-	-	S40	-	-	-	-	
35	-	-	57	-	-	S41	-	-	-	-	
36	-	-	-	-	-	21	-	-	-	-	
37	-	-	-	-	-	-	-	-	-	-	
38	-	-	-	-	-	-	-	-	-	-	
39	-	-	-	-	-	-	-	-	-	-	
40	-	-	-	-	-	-	-	-	-	-	
41	-	-	-	-	-	-	-	-	-	-	
42	62	62	-	62	62	24	62	62	62	62	
43	63	63	-	63	63	25	63	63	63	C13	
44	-	-	-	-	-	-	-	-	-	-	
45	-	-	-	-	-	-	-	-	-	-	
46	-	-	-	-	-	-	-	-	-	-	
47	-	-	-	-	-	-	-	-	-	-	
48	-	-	-	-	-	-	-	-	-	-	
49	69	69	-	69	69	31	69	69	69	-	
50	-	-	-	-	-	-	-	-	-	-	
51	-	-	-	-	-	-	-	-	-	-	
52	-	-	-	-	-	-	-	-	-	-	
53	-	-	-	-	-	-	-	-	-	-	
54	-	-	-	-	-	-	-	-	-	-	
55	-	-	-	-	-	-	-	-	-	-	
56	-	-	-	-	-	-	-	-	-	-	
57	-	-	-	-	-	-	-	-	-	-	
58	-	-	-	-	-	-	-	-	-	-	
59	-	-	-	-	-	-	-	-	-	-	
60	-	-	-	-	-	-	-	-	-	-	
61	-	-	-	-	-	-	-	-	-	-	
62	-	-	-	-	-	-	-	-	-	-	
63	-	-	-	-	-	-	-	-	-	-	
64	-	-	-	-	-	-	-	-	-	-	
65	-	-	-	-	-	-	-	-	-	-	
66	-	-	-	-	-	-	-	-	-	-	
67	-	-	-	-	-	-	-	-	-	-	
68	-	-	-	-	-	-	-	-	-	-	
69	-	-	-	-	-	-	-	-	-	-	
70	-	-	-	-	-	32	-	-	-	-	
71	-	-	-	-	-	-	-	-	-	-	
72	-	-	-	-	-	-	-	-	-	-	
73	-	-	-	-	-	-	-	-	-	-	
74	S'1	S'1	-	S'1	S'1	-	S'1	-	-	-	
75	S'2	-	-	S'2	S'2	-	S'2	-	-	-	
76	S'3	-	-	S'3	S'3	-	S'3	-	-	-	
77	-	-	-	-	-	-	-	-	-	-	
78	-	-	-	-	-	-	-	-	-	-	
79	-	-	-	-	-	41	-	-	-	-	
80	S1	S1	-	S1	S1	42	S1	-	-	-	
81	S2	S2	Z1	S2	S2	-	S2	-	-	-	
82	-	-	-	-	-	-	-	-	-	-	
83	-	-	-	-	-	-	-	-	-	-	
84	-	-	-	-	-	-	-	-	-	-	
85	-	-	-	-	-	-	-	-	-	-	
86	-	-	-	-	-	-	-	-	-	-	
87	-	-	-	-	-	-	-	-	-	-	
88	-	-	-	-	-	-	-	-	-	-	
89	S10	S10	Z9	S10	S10	51	S10	-	-	-	
90	S11	S11	Z10	S11	S11	52	-	-	-	-	
91	S12	S12	Z11	S12	S12	-	-	-	-	-	
92	S13	S13	Z12	S13	S13	-	-	-	-	-	
93	S14	S14	Z13	S14	S14	-	S14	-	-	-	
94	S15	S15	Z14	S15	S15	-	S15	-	-	-	
95	S16	S16	Z15	S16	S16	-	S16	-	-	-	
96	S17	S17	Z16	S17	S17	-	S17	-	-	-	
97	S18	S18	Z17	S18	S18	-	S18	-	-	-	
98	S19	S19	Z18	S19	S19	-	S19	-	-	-	
99	S20	S20	Z19	S20	S20	61	S20	-	99	C49	
100	S21	S21	Z20	S21	S21	62	S21	-	100	-	
101	-	-	-	-	-	-	-	-	-	-	
102	-	-	-	-	-	-	-	-	-	-	
103	-	-	-	-	-	-	-	-	-	-	
104	-	-	-	-	-	-	-	-	-	-	
105	-	-	-	-	-	-	-	-	-	-	
106	-	-	-	-	-	-	-	-	-	-	
107	-	-	-	-	-	69	-	-	-	-	
108	-	-	-	-	-	70	-	-	-	-	
109	-	-	-	-	-	-	-	-	-	-	
110	-	-	-	-	-	-	-	-	-	-	
111	-	-	-	-	-	-	-	-	-	-	
112	-	-	-	-	-	-	-	-	-	-	
113	-	-	-	-	-	-	-	-	-	-	
114	-	-	-	-	-	-	-	-	-	-	
115	-	-	-	-	-	-	-	-	-	-	
116	-	-	-	-	-	-	-	-	-	-	
117	-	-	-	-	-	-	-	-	-	-	
118	-	-	-	-	-	-	-	-	-	-	
119	-	-	-	-	-	-	-	-	-	-	
120	S41	S41	-	S41	S41	-	S41	-	-	-	
121	-	-	-	-	-	-	-	-	-	-	
122	-	-	-	-	-	-	-	-	-	-	
123	-	-	-	-	-	-	-	-	-	-	
124	-	-	-	-	-	-	-	-	-	-	
125	-	-	-	-	-	-	-	-	125	-	

Stereo / Bilingual Sound Selection

⊞/▽ When you receive the stereo / bilingual sound system, sound output modes can be selected by pressing the **Stereo / Bilingual Sound Selection** button.

Audio Signal	STEREO	MAIN I	SUB II	MONO
Mode Indicator	⊞	I	II	▽

NICAMUsed in New Zealand, Singapore, Hong Kong etc.

Type of broadcast	Regular broadcast (Standard Audio)	Regular + NICAM MONO I (MAIN I)	NICAM STEREO	NICAM DUAL MONO (MAIN I / SUB II)
Mode Indicator	No Indicator ← ▽	I ← ▽	⊞ ← ▽	I → ▽ II

A2 (German)Used in Australia, Malaysia etc.

Type of broadcast	Regular broadcast (Standard Audio)	BILINGUAL or DUAL MONO: MAIN I / SUB II	STEREO
Mode Indicator	No Indicator ← ▽	I ← II	⊞ ← ▽

- If the stereo signal is poor or the receiving conditions are not optimum or if STEREO:MONO automatic switching occurs, it is recommended you switch from STEREO to MONO.
- Even when the contents of the receiving signal undergo changes, selection mode is kept intact.
- When the receiving conditions deteriorate, listening will be easier if the mode is set to the MONO position, using the stereo / bilingual sound selection button.
- DUAL, also known as DUAL MONO or as BILINGUAL is not currently transmitted in some countries.

Technical Information

HDMI connection

HDMI (high-definition multimedia interface) is the world's first complete digital consumer AV interface complying with a non-compression standard.

HDMI allows you to enjoy high-definition digital images and high-quality sound by connecting the TV and the equipment.

HDMI-compatible equipment (*1) with an HDMI or DVI output terminal, such as a DVD player, a set top box or a game equipment, can be connected to the HDMI terminal using an HDMI compliant (fully wired) cable. About connections, see "External Equipment" (p. 38, 39).

Applicable HDMI features

- Input audio signal : 2ch Linear PCM (sampling frequencies - 48 kHz, 44.1 kHz, 32 kHz)
- Input video signal : 480i, 480p, 576i, 576p, 720p, 1080i and 1080p
 - ➔ "Input signal that can be displayed" (p. 43)
 - Match the output setting of the digital equipment.
- Input PC signal : ➔ "Input signal that can be displayed" (p. 43)
 - Match the output setting of the PC.
- VIERA Link (HDAVI Control 5) : ➔ "VIERA Link" (p. 34)
- Audio Return Channel (*2) (HDMI2 terminal only)

DVI connection

If the external equipment has only a DVI output, connect to the HDMI terminal via a DVI to HDMI adapter cable (*3).

When the DVI to HDMI adapter cable is used, connect the audio cable to the audio input terminal (HDMI1 / 2: use COMPONENT-AUDIO terminals / HDMI3: use AV3 audio terminals).

Note

- Audio settings can be made on the "HDMI1 / 2 / 3 Input" in the Sound Menu. (p. 24)
- If the connected equipment has an aspect adjustment function, set the aspect ratio to "16:9".
- These HDMI connectors are "type A".
- These HDMI connectors are compatible with HDCP (High-Bandwidth Digital Content Protection) copyright protection.
- An equipment having no digital output terminal may be connected to the input terminal of either "COMPONENT" or "VIDEO" to receive analogue signals.
- This TV incorporates HDMI™ technology.

(*1): The HDMI logo is displayed on HDMI-compliant equipment.

(*2): Audio Return Channel (ARC) is a function to be able to send digital sound signals via an HDMI cable.

(*3): Enquire at your local digital equipment retailer shop.

PC connection

A PC may be connected to this TV so that the PC screen is displayed and sound is heard from the TV.

- PC signals that can be inputted: Horizontal scanning frequency 31 to 69 kHz; vertical scanning frequency 59 to 86 Hz. More than 1,024 signal lines could result in incorrect display of the image.
- A PC adapter is not necessary for the DQS/V-compliant D-sub 15-pin connector.

Note

- Some PC models cannot be connected to this TV.
- When using PC, set the colour display quality of PC to the highest position.
- For details of the applicable PC signals, see p. 43.
- Max. display resolution

Aspect	4:3	768 × 768 pixels
	16:9	1,024 × 768 pixels

- D-sub 15-pin connector signal

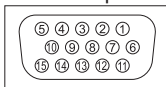

Pin No.	Signal Name	Pin No.	Signal Name	Pin No.	Signal Name
①	R	⑥	GND (Ground)	⑪	NC (not connected)
②	G	⑦	GND (Ground)	⑫	NC (not connected)
③	B	⑧	GND (Ground)	⑬	HD
④	NC (not connected)	⑨	NC (not connected)	⑭	VD
⑤	GND (Ground)	⑩	GND (Ground)	⑮	NC (not connected)

Input signal that can be displayed

COMPONENT (Y, P_B/C_B, P_R/C_R), HDMI

* Mark: Applicable input signal

Signal name	COMPONENT	HDMI
525 (480) / 60i	*	*
525 (480) / 60p	*	*
625 (576) / 50i	*	*
625 (576) / 50p	*	*
750 (720) / 60p	*	*
750 (720) / 50p	*	*
1,125 (1,080) / 60i	*	*
1,125 (1,080) / 50i	*	*
1,125 (1,080) / 60p	*	*
1,125 (1,080) / 50p	*	*
1,125 (1,080) / 24p	*	*

PC (from D-sub 15P)

Applicable input signal for PC is basically compatible to VESA standard timing.

Signal name	Horizontal frequency (kHz)	Vertical frequency (Hz)
640 × 400 @70 Hz	31.47	70.07
640 × 480 @60 Hz	31.47	59.94
640 × 480 @75 Hz	37.50	75.00
800 × 600 @60 Hz	37.88	60.32
800 × 600 @75 Hz	46.88	75.00
800 × 600 @85 Hz	53.67	85.06
852 × 480 @60 Hz	31.44	59.89
1,024 × 768 @60 Hz	48.36	60.00
1,024 × 768 @70 Hz	56.48	70.07
1,024 × 768 @75 Hz	60.02	75.03
1,024 × 768 @85 Hz	68.68	85.00
1,280 × 1,024 @60 Hz	63.98	60.02
1,280 × 768 @60 Hz	47.70	60.00
1,366 × 768 @60 Hz	48.39	60.04
Macintosh13" (640 × 480)	35.00	66.67
Macintosh16" (832 × 624)	49.73	74.55
Macintosh21" (1,152 × 870)	68.68	75.06

PC (from HDMI terminal)

Applicable input signal for PC is basically compatible to HDMI standard timing.

Signal name	Horizontal frequency (kHz)	Vertical frequency (Hz)
640 × 480 @60 Hz	31.47	60.00
750 (720) / 60p	45.00	60.00
1,125 (1,080) / 60p	67.50	60.00

Note

- Signals other than above may not be displayed properly.
- The above signals are reformatted for optimal viewing on your display.
- PC signal is magnified or compressed for display, so that it may not be possible to show fine detail with sufficient clarity.

Technical Information

SD Card

Use an SD Card which meets SD standards.
If not, it may cause the TV to malfunction.

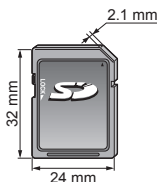

Cautions in handling SD Card

- Do not remove the card while the TV is accessing data (this can damage card or TV).
- Do not touch the pins on the back of the card.
- Do not subject the card to a high pressure or impact.
- Insert the card in the correct direction (otherwise, card may be damaged).
- Electrical interference, static electricity, or erroneous operation may damage the data or card.
- Back up the recorded data at regular intervals in case of deteriorated or damaged data or erratic operation of the TV. (Panasonic is not liable for any deterioration or damage of recorded data.)

Data format for Card browsing

- Photo : Still images recorded with digital still cameras compatible with JPEG files of DCF* and EXIF standards
Data format - Baseline JPEG (Sub-sampling 4:4:4, 4:2:2 or 4:2:0)
Max. number of files - 9,999
Image resolution - 160 × 120 to 20,000,000
- Card format : SDHC Card / SD Card - FAT16 or FAT32
- Compliant card type (maximum capacity): SDHC Card (32 GB), SD Card (2 GB), miniSD Card (2 GB) (requiring miniSD adapter)
- If miniSD Card is used, insert / remove it together with the adapter.
- Check the latest information on the card type at the following website. (English only)
<http://panasonic.jp/support/global/cs/>

*DCF (Design rule for camera file system): Unified standard established by Japan Electronics and Information Technology Industries Association (JEITA).

Note

- Format the card with the recording equipment.
- The picture may not appear correctly on this TV depending on the recording equipment used.
- Display may take some time when there are many files and folders.
- This function cannot display Motion JPEG and still image not JPEG formatted (i.e. TIFF, BMP).
- A data modified with a PC may not be displayed.
- Images imported from a PC must be compatible with EXIF (Exchangeable Image File) 2.0, 2.1, and 2.2.
- Partly degraded files might be displayed at a reduced resolution.
- The folder and file names may be different depending on the digital video camera used.
- Do not use two-byte characters or other special codes.
- The card may become unusable with this TV if the file or folder names are changed.

On screen messages

Message	Meaning / Action
Cannot read file	<ul style="list-style-type: none"> ● The file is broken or unreadable. ● The TV does not support the format. (For the applicable formats and data, see above.)
No SD card inserted	<ul style="list-style-type: none"> ● Confirm SD Card is inserted correctly.
No valid file to play	<ul style="list-style-type: none"> ● The card has no data.
Over 9999 pictures found. (max. is 9999)	<ul style="list-style-type: none"> ● Maximum valid number of photos is 9,999.
This operation is not possible	<ul style="list-style-type: none"> ● Your operation is not available.

Maintenance

First, remove the mains plug from the socket outlet.

Display panel, Cabinet, Pedestal

For regular care:

Gently wipe the surface of the display panel, cabinet, or pedestal by using a soft cloth to clean the dirt or fingerprints.

For stubborn dirt:

Dampen a soft cloth with clean water or diluted neutral detergent (1 part detergent to 100 parts water). Then wring the cloth and wipe the surface. Finally, wipe away all the moisture.

Caution

- Do not use a hard cloth or rub the surface too hard. This may cause scratches on the surface.
- Take care not to subject the TV's surfaces to water or detergent. A liquid inside the TV could lead to product failure.
- Take care not to subject the surfaces to insect repellent, solvent, thinner, or other volatile substances. This may degrade surface quality or cause peeling of the paint.
- Take care not to tap or scratch the surface with your fingernail or other hard objects.
- Do not allow the cabinet and pedestal to make contact with a rubber or PVC substance for a long time. This may degrade surface quality.

Mains plug

Wipe the mains plug with a dry cloth at regular intervals. Moisture and dust may lead to fire or electrical shock.

FAQs

Before requesting service or assistance, please follow these simple guides to resolve the problem. If the problem still persists, please contact your local Panasonic dealer for assistance.

White spots or shadow images (noise)



- Check the position, direction, and connection of the aerial.

Neither image nor sound is produced

- Is the TV in "AV mode"?
- Is the mains lead plugged into the socket outlet?
- Is the TV turned On?
- Check Picture Menu (p. 23) and volume.
- Check all required cables and connections are firmly in place.

An error message appears

- Follow the message's instructions.
- If the problem persists, contact your local Panasonic dealer.



"VIERA Link" function does not work and an error message appears

- Confirm the connection.
- Turn the connected equipment on and then switch the TV on. (p. 34)

Permanently lit spots on screen

- Due to production process involved in this technology this may result in some pixels which are permanently lit or unlit. This is not a malfunction.

Contrast is reduced

- Contrast is lowered in the following conditions without any user operation for a few minutes:
 - no signal in AV mode
 - selected locked programme
 - selected invalid programme
 - displayed menu
 - Thumbnail or still picture in SD Card mode

FAQs

	Problem	Actions
Screen	Chaotic image, noisy	<ul style="list-style-type: none"> ● Change the setting of “P-NR” in the Picture Menu (to remove noise) (p. 23). ● Check nearby electrical products (car, motorcycle, fluorescent lamp).
	No image can be displayed	<ul style="list-style-type: none"> ● Is “Colour” or “Contrast” in the Picture Menu set to the minimum? (p. 23)
	Blurry or distorted image (no sound or low volume)	<ul style="list-style-type: none"> ● Reset channels (p. 28).
	Unusual image is displayed	<ul style="list-style-type: none"> ● Turn off the TV with Mains power On / Off switch, then turn it on again.
Sound	No sound is produced	<ul style="list-style-type: none"> ● Is “Sound Mute” active? (p. 10) ● Is the volume set to the minimum?
	Sound level is low or sound is distorted	<ul style="list-style-type: none"> ● Sound signal reception may be deteriorated. ● Set “MPX” in the Sound Menu to “Mono” (p. 24).
	Unusual sound from the display unit	<ul style="list-style-type: none"> ● When power is on, drive noise may be heard from inside the display unit (not a sign of faulty operation).
HDMI	Sound is unusual	<ul style="list-style-type: none"> ● Set the sound setting of the connected equipment to “2ch L.PCM”. ● Check the “HDMI1 / 2 / 3 Input” setting in the Sound Menu (p. 24). ● If digital sound connection has a problem, select analogue sound connection (p. 42).
	Pictures from external equipment are unusual when the equipment is connected via HDMI	<ul style="list-style-type: none"> ● Is the HDMI cable connected properly? (p. 34, 38, 39) ● Turn Off the TV and equipment, then turn them On again. ● Check an input signal from the equipment (p. 43). ● Use an equipment compliant with EIA/CEA-861/861B.
Other	TV goes into Standby mode	<ul style="list-style-type: none"> ● Auto power standby function is activated. ● The TV enters Standby mode about 30 mins. after broadcasting ends.
	The remote control does not work or is intermittent	<ul style="list-style-type: none"> ● Are the batteries installed correctly? (p. 3) ● Has the TV been switched On? ● Point the remote control directly at the front of the TV (within a 30 degree angle of the front of the TV). ● Situate the TV away from sunshine or other sources of bright light not to shine on the TV’s remote control signal receiver.
	Parts of the TV become hot	<ul style="list-style-type: none"> ● Even when the temperature of parts of the front, top and rear panels has risen, these temperature rises will not pose any problems in terms of performance or quality.

Specifications

		TH-P42X20K TH-P42X20M TH-P42X20R TH-P42X20V	TH-P42X20P	TH-P46X2G TH-P46X20K TH-P46X20M TH-P46X20R TH-P46X20V	TH-P46X20P	TH-P50X20K TH-P50X20M TH-P50X20R TH-P50X20V	TH-P50X20P											
Power Source		AC 220 - 240 V, 50 / 60 Hz	AC 110 - 240 V, 50 / 60 Hz	AC 220 - 240 V, 50 / 60 Hz	AC 110 - 240 V, 50 / 60 Hz	AC 220 - 240 V, 50 / 60 Hz	AC 110 - 240 V, 50 / 60 Hz											
Power Consumption	Average use	230 W	230 W	250 W	250 W	290 W	295 W											
	Standby condition	0.45 W	0.45 W	0.45 W	0.45 W	0.45 W	0.45 W											
Display panel	Aspect Ratio	16:9																
	Visible screen size	106 cm (diagonal) 921 mm (W) × 518 mm (H)		117 cm (diagonal) 1,019 mm (W) × 573 mm (H)		127 cm (diagonal) 1,105 mm (W) × 622 mm (H)												
	Number of pixels	786,432 (1,024 (W) × 768 (H)) [3,072 × 768 dots]																
Sound	Speaker	160 mm × 40 mm × 2 pcs, 6 Ω																
	Audio Output	20 W (10 W + 10 W)																
	Headphones	M3 (3.5 mm) stereo mini Jack × 1																
PC signals		VGA, SVGA, WVGA, XGA SXGA, WXGA (compressed) Horizontal scanning frequency 31 - 69 kHz Vertical scanning frequency 59 - 86 Hz																
Receiving Systems / Band name		17 Systems		Function		17 Systems		Function										
		1 PAL B, G, H	2 PAL I	3 PAL D, K	4 SECAM B, G	5 SECAM D, K	6 SECAM K1	7 NTSC M (NTSC 3.58/4.5 MHz)	8 NTSC 4.43/5.5 MHz	9 NTSC 4.43/6.0 MHz	10 NTSC 4.43/6.5 MHz	11 NTSC 3.58/5.5 MHz	12 NTSC 3.58/6.0 MHz	13 NTSC 3.58/6.5 MHz	14 SECAM I	15 PAL 60 Hz/5.5 MHz	16 PAL 60 Hz/6.0 MHz	17 PAL 60 Hz/6.5 MHz
Receiving Channels (Analogue TV)		PAL B/G 2-12 (PAL/SECAM B, K1) 0-12 (PAL B AUST.) 1-9 (PAL B N.Z.) 1-12 (PAL/SECAM D) 1-12 (NTSC M Japan) 2-13 (NTSC M USA)		UHF BAND 21-69 (PAL G, H, I/SECAM G, K, K1) 28-69 (PAL B AUST.) 13-57 (PAL D, K) 13-62 (NTSC M Japan) 14-69 (NTSC M USA)		CATV S1-S20 (OSCAR) 1-125 (USA CATV) C13-C49 (JAPAN) S21-S41 (HYPER) Z1-Z37 (CHINA) 5A, 9A (AUST.)												
Aerial - Rear		VHF / UHF																
Operating Conditions		Temperature : 0 °C - 40 °C Humidity : 20 % - 80 % RH (non-condensing)																
Connection Terminals	AV1 Input	AUDIO L - R	RCA PIN Type × 2		0.5 V[rms]													
		VIDEO	RCA PIN Type × 1		1.0 V[p-p] (75 Ω)													
		COMPONENT	Y P _B /C _B , P _R /C _R		1.0 V[p-p] (including synchronization) ±0.35 V[p-p]													
	AV2 Input	AUDIO L - R	RCA PIN Type × 2		0.5 V[rms]													
		VIDEO	RCA PIN Type × 1		1.0 V[p-p] (75 Ω)													
	AV3 Input	AUDIO L - R	RCA PIN Type × 2		0.5 V[rms]													
		VIDEO	RCA PIN Type × 1		1.0 V[p-p] (75 Ω)													
	Monitor Output	AUDIO L - R	RCA PIN Type × 2		0.5 V[rms] (high impedance)													
		VIDEO	RCA PIN Type × 1		1.0 V[p-p] (75 Ω)													
	Others	HDMI1 - 3 Input	TYPE A Connectors		● This TV supports "HDAVI control 5" function.													
PC Input		HIGH-DENSITY D-SUB 15PIN		R / G / B: 0.7 V[p-p] (75 Ω) HD / VD: TTL Level 2.0 - 5.0 V[p-p] (high impedance)														
Card slot		SD Card slot × 1																
Dimensions (W × H × D)		1,029 mm × 704 mm × 307 mm (With Pedestal) 1,029 mm × 661 mm × 93 mm (TV only)		TH-P46X2G / TH-P46X20K / TH-P46X20V 1,132 mm × 767 mm × 401 mm (With Pedestal) 1,132 mm × 722 mm × 93 mm (TV only) TH-P46X20M / TH-P46X20P / TH-P46X20R 1,132 mm × 771 mm × 357 mm (With Pedestal) 1,132 mm × 722 mm × 93 mm (TV only)		TH-P50X20K / TH-P50X20V 1,218 mm × 814 mm × 401 mm (With Pedestal) 1,218 mm × 769 mm × 93 mm (TV only) TH-P50X20M / TH-P50X20P / TH-P50X20R 1,218 mm × 817 mm × 357 mm (With Pedestal) 1,218 mm × 769 mm × 93 mm (TV only)												
Mass		25.5 kg Net (With Pedestal) 24.0 kg Net (TV only)		TH-P46X2G / TH-P46X20K / TH-P46X20V 31.0 kg Net (With Pedestal) / 28.0 kg Net (TV only) TH-P46X20M / TH-P46X20P / TH-P46X20R 30.0 kg Net (With Pedestal) / 28.0 kg Net (TV only)		TH-P50X20K / TH-P50X20V 34.0 kg Net (With Pedestal) / 31.0 kg Net (TV only) TH-P50X20M / TH-P50X20P / TH-P50X20R 33.0 kg Net (With Pedestal) / 31.0 kg Net (TV only)												

FAQs Specifications

Technical

Note

● Design and Specifications are subject to change without notice. Mass and Dimensions shown are approximate.