

Customer's Record

The model number and serial number of this product may be found on its rear panel. You should note the model number and the serial number in the space provided below and retain this book, plus your purchase receipt, as a permanent record of your purchase to aid in identification in the event of theft or loss, and for Warranty Service purposes.

Model Number**Serial Number****Panasonic Corporation**M0211-1031
Printed in ThailandWeb Site : <http://panasonic.net>
© Panasonic Corporation 2011

Panasonic®

Model No.

TH-P42X30D	TH-P50X30D
TH-P42X30K	TH-P50X30K
TH-P42X30M	TH-P50X30M
TH-P42X30P	TH-P50X30P
TH-P42X30Q	TH-P50X30Q
TH-P42X30T	TH-P50X30T
TH-P42X30V	TH-P50X30V

Operating Instructions Plasma Television

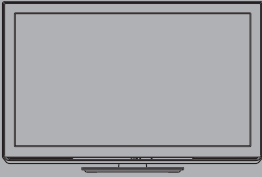

VIERA

Thank you for purchasing this Panasonic product.
Please read these instructions before operating your set and retain
them for future reference.
The images shown in this manual are for illustrative purposes only.

English



TQB4TC0027-1







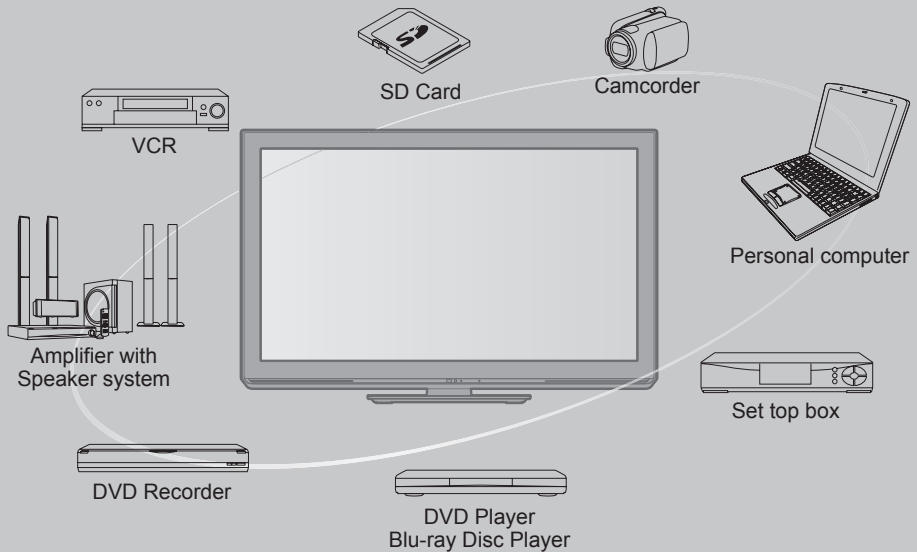

Experience an amazing level of multimedia excitement

Sharp pictures with HDMI terminal
Create home theatre and DVD recorder link-ups with "VIERA Link"
without complicated settings!

Enjoy rich multimedia



This product is licensed under the AVC patent portfolio license for the personal and non-commercial use of a consumer to (i) encode video in compliance with the AVC Standard ("AVC Video") and/or (ii) decode AVC Video that was encoded by a consumer engaged in a personal and non-commercial activity and/or was obtained from a video provider licensed to provide AVC Video. No license is granted or shall be implied for any other use. Additional information may be obtained from MPEG LA, LLC. See <http://www.mpegla.com>.

	<p>DLNA®, the DLNA Logo and DLNA CERTIFIED™ are trademarks, service marks, or certification marks of the Digital Living Network Alliance.</p>
	<p>HDMI, the HDMI Logo and High-Definition Multimedia Interface are trademarks or registered trademarks of HDMI Licensing LLC in the United States and other countries.</p>
	<p>“AVCHD” and the “AVCHD” logo are trademarks of Panasonic Corporation and Sony Corporation.</p>
	<p>Manufactured under license from Dolby Laboratories. Dolby and the double-D symbol are trademarks of Dolby Laboratories.</p>
	<p>DivX®, DivX Certified® and associated logos are trademarks of DivX, Inc. and are used under license.</p>
	<p>QuickTime and the QuickTime logo are trademarks or registered trademarks of Apple Inc., used under license therefrom.</p>
	<p>SDXC Logo is a trademark of SD-3C, LLC.</p>
	
<p>VGA is a trademark of International Business Machines Corporation.</p>	
<p>S-VGA is a registered trademark of the Video Electronics Standard Association.</p>	
<p>HDAVI Control™ is a trademark of Panasonic Corporation.</p>	
<p>Macintosh is a trademark of Apple Inc.</p>	
<p>Windows is a registered trademark of Microsoft Corporation in the United States and/or other countries.</p>	

Even if no special notation has been made of company or product trademarks, these trademarks have been fully respected.

Be Sure to Read

Safety Precautions4
 (Warning / Caution)
 Notes5

Quick Start Guide

Accessories / Options6
 Basic Connection9
 Identifying Controls10
 Auto Tuning12

Basic Features

Watching TV14
 Viewing Teletext17
 Watching External Inputs19
 How to Use VIERA TOOLS20
 How to Use the Menu Functions21

Advanced Features

Tuning and Editing Channels28
 Child Lock30
 Input Labels31
 Shipping Condition (Reset settings)32
 Using Media Player33
 Using Network Services42
 VIERA Link Functions51
 External Equipment56

Technical

Technical Information59
 Maintenance67
 FAQs68
 Specifications70

Safety Precautions

Warning

Handling the mains plug and lead

- Insert the mains plug fully into the socket outlet. (If the mains plug is loose, it could generate heat and cause fire.)
- Ensure that the mains plug is easily accessible.
- Ensure the earth pin on the mains plug is securely connected to prevent electrical shock.
 - An apparatus with CLASS I construction shall be connected to a mains socket outlet with a protective earthing connection.
- Do not touch the mains plug with a wet hand. (This may cause electrical shock.)
- Do not use any mains lead other than that provided with this TV. (This may cause fire or electrical shock.)
- Do not damage the mains lead. (A damaged lead may cause fire or electrical shock.)
 - Do not move the TV with the lead plugged in the socket outlet.
 - Do not place a heavy object on the lead or place the lead near a high-temperature object.
 - Do not twist the lead, bend it excessively, or stretch it.
 - Do not pull on the lead. Hold onto the mains plug body when disconnecting the lead.
 - Do not use a damaged mains plug or socket outlet.

If you find any abnormality, remove the mains plug immediately!

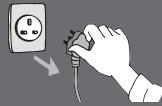

- Mains plug types vary between countries.

Power source

This TV is designed to operate on:

- AC 220 - 240 V, 50 / 60 Hz (TH-P42X30D / TH-P50X30D, TH-P42X30K / TH-P50X30K, TH-P42X30M / TH-P50X30M, TH-P42X30Q / TH-P50X30Q, TH-P42X30T / TH-P50X30T, TH-P42X30V / TH-P50X30V)
- AC 110 - 240 V, 50 / 60 Hz (TH-P42X30P / TH-P50X30P)

Do not remove covers and

NEVER modify the TV yourself

- Do not remove the rear cover as live parts are accessible when it is removed. There are no user serviceable parts inside. (High-voltage components may cause serious electrical shock.)
- Have the TV checked, adjusted, or repaired at your local Panasonic dealer.

Do not insert foreign objects into the TV

- Do not allow any objects to drop into the TV through the air vents. (Fire or electrical shock may result.)

Do not place the TV on sloped or unstable surfaces

- The TV may fall off or tip over.

Do not expose to rain or excessive moisture

- To prevent damage which might result in electric shock or fire, do not expose this TV to rain or excessive moisture. This TV must not be exposed to dripping or splashing water and objects filled with liquid, such as vases, must not be placed on top of or above the TV.

Use only the dedicated pedestals / mounting equipment

- Using an unapproved pedestal or other fixtures may make the TV unstable, risking injury. Be sure to ask your local Panasonic dealer to perform setup.
- Use approved pedestals (p. 6) / wall-hanging brackets (p. 8).

Do not expose to direct sunlight and other sources of heat

- Avoid exposing the TV to direct sunlight and other sources of heat.

Do not allow children to handle SD Card

- As with any small object, SD Cards can be swallowed by young children. Please remove SD Card immediately after use and store out of reach of children.



To prevent the spread of fire, keep candles or other open flames away from this product at all times

Caution

This appliance is intended for use in tropical climates

When cleaning the TV, remove the mains plug

- Cleaning an energised TV may cause electrical shock.

When the TV is not going to be used for a long period of time, remove the mains plug

- This TV will still consume some power even in the Off mode, as long as the mains plug is still connected to a live socket outlet.

Transport only in upright position

- Transporting the TV with its display panel facing upward or downward may cause damage to the internal circuitry.

Allow sufficient space around the TV for radiated heat

Minimum distance

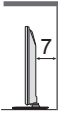
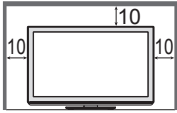

(cm)

- When using the pedestal, keep the space between the bottom of the TV and the surface where the TV is set.
- If using a Wall-hanging bracket, refer to its manual.

Do not block the rear air vents

- Blocked ventilation by newspapers, table cloths, curtains, etc. may cause overheating, fire or electrical shock.

Do not apply strong force or impact to the display panel

- This may cause damage resulting in injury.

Do not expose your ears to excessive volume from the headphones

- Irreversible damage can be caused.

The TV is heavy. Handle the TV by 2 or more people. Support as shown to avoid injury by the TV tipping or falling.

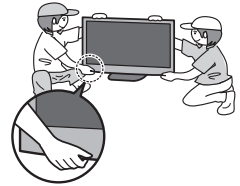

Notes

Do not display a still picture for a long time

This causes the image to remain on the plasma screen ("image retention"). This is not considered a malfunction and is not covered by the warranty.

Typical still images

- Programme number and other logos
- Image displayed in 4:3 mode



- Video game
- Computer image

To prevent image retention, contrast is lowered automatically after a few minutes if no signals are sent or no operations are performed. (p. 68)

Auto power standby function

- The TV will automatically go into Standby mode in the following conditions:
 - no signal is received and no operation is performed for 30 minutes
 - [Off Timer] is active in the Setup Menu (p. 14)
 - no operation is performed for the period selected in [Auto Standby] (p. 27)

Keep the TV away from these types of equipment

- Electronic equipment
In particular, do not place video equipment near the TV. Electromagnetic interference may distort images / sound.
- Equipment with an infrared sensor
This TV also emits infrared rays. This may affect operation of other equipment.

Accessories / Options

Standard accessories

Remote Control
• N2QAYB000603



Batteries for the Remote Control (2)
• R6 (AA)



Pedestal
➔ (p. 7)

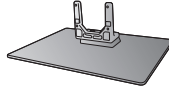

Ferrite core (2)
(TH-P42X30Q, TH-P50X30Q)
• J0KG00000014
➔ (p. 58)



Use the Ferrite cores to comply with the EMC standard.

Mains Lead ➔ (p. 9)

(TH-P42X30K TH-P50X30K)
(TH-P42X30M TH-P50X30M)
(TH-P42X30P TH-P50X30P)

(TH-P42X30D)
(TH-P42X30Q)
(TH-P50X30D)
(TH-P50X30Q)

(TH-P42X30T)
(TH-P50X30T)

(TH-P42X30V)
(TH-P50X30V)

Operating Instructions

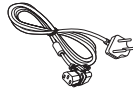

- This product contains possibly dangerous parts (such as plastic bags), which can be breathed in or swallowed by young children accidentally. Keep these parts out of reach of young children.

Inserting and removing remote's batteries

1

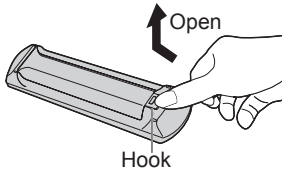

2

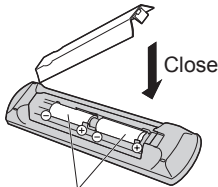

Note the correct polarity (+ or -)

Caution

- Incorrect installation may cause battery leakage and corrosion, resulting in damage to the remote control.
- Do not mix old and new batteries.
- Do not mix different battery types (such as alkaline and manganese batteries).
- Do not use rechargeable (Ni-Cd) batteries.
- Do not burn or breakup batteries. Batteries must not be exposed to excessive heat such as sunshine, fire or the like.
- Do not disassemble or modify the remote control.

Attaching the pedestal

Warning

Do not disassemble or modify the pedestal.

- Otherwise the TV may fall over and become damaged, and personal injury may result.

Caution

Do not use any pedestal other than that provided with this TV.

- Otherwise the TV or the display may fall over and become damaged, and personal injury may result.

Do not use the pedestal if it becomes warped or physically damaged.

- If you use the pedestal while it is physically damaged, personal injury may result. Contact your nearest Panasonic dealer immediately.

During set-up, make sure that all screws are securely tightened.



- If insufficient care is taken to ensure screws are properly tightened during assembly, the pedestal will not be strong enough to support the TV, and it might fall over and become damaged, and personal injury may result.

Ensure that the TV does not fall over.

- If the TV is knocked or children climb onto the pedestal with the TV installed, the TV may fall over and personal injury may result.

Two or more people are required to install and remove the TV.

- If two or more people are not present, the TV may be dropped, and personal injury may result.

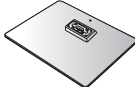
A Assembly screw (4) (silver) <ul style="list-style-type: none">• M5 × 20 (mm) 	B Assembly screw (4) (black) <ul style="list-style-type: none">• M5 × 25 (mm) 	C Pole <ul style="list-style-type: none">• TBL5ZA3035 	D Base <ul style="list-style-type: none">• TBL5ZX0050• TH-P42X30D• TH-P42X30K• TH-P42X30M• TH-P42X30P• TH-P42X30Q• TH-P42X30T• TH-P42X30V 	<ul style="list-style-type: none">• TBL5ZX0052• TH-P50X30D• TH-P50X30K• TH-P50X30M• TH-P50X30P• TH-P50X30Q• TH-P50X30T• TH-P50X30V
---	--	--	---	---

Assembling the pedestal

Use the assembly screws (A) to fasten the pole (C) to the base (D) securely.

- Make sure that the screws are securely tightened.
- Forcing the assembly screws the wrong way will strip the threads.

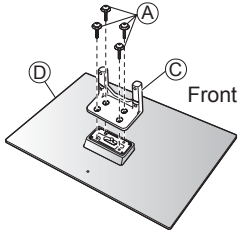

Securing the TV

Insert the pole into the TV, and then fasten securely with the assembly screws (B).

- Tighten the four assembly screws loosely at first, then tighten them firmly to fix securely.
- Carry out the work on a horizontal and level surface.

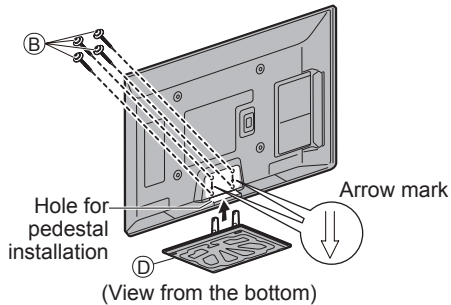

Optional accessories

Please contact your nearest Panasonic dealer to purchase the recommended optional accessories. For additional details, please refer to the manual of the optional accessories.

Wireless LAN Adaptor and Extension Cable



Please refer to the following web site for usable Wireless LAN Adaptor. (English only)

<http://panasonic.jp/support/global/cs/tv/>

- Additional information for Wireless LAN Adaptor and access point may also be on this web site.

Caution

- To use the Wireless LAN Adaptor, an Access Point needs to be obtained.
- It is recommended to use the Wireless LAN Adaptor with the extension cable.
- To avoid radio wave interference, keep the TV away from the devices such as other wireless LAN devices, microwaves and the devices that use 2.4 GHz and 5 GHz signals when using the Wireless LAN Adaptor. Otherwise malfunction may occur.
- Depending on the area, this optional accessory may not be available.

Wall-hanging bracket

- TY-WK4P1RW

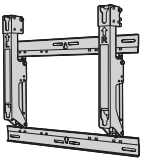

Rear of the TV

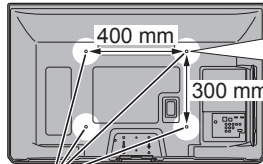

Holes for wall-hanging bracket installation

Screw for fixing the TV onto the wall-hanging bracket (not supplied with the TV)

Depth of screw:
minimum 15 mm
maximum 30 mm

Screw Thread Type: M8

(View from the side)

Warning

- Using other wall-hanging brackets, or installing a wall-hanging bracket by yourself have the risk of personal injury and product damage. In order to maintain the unit's performance and safety, be absolutely sure to ask your dealer or a licensed contractor to secure the wall-hanging brackets. Any damage caused by installing without a qualified installer will void your warranty.
- Carefully read the instructions accompanying optional accessories, and be absolutely sure to take steps to prevent the TV from falling off.
- Handle the TV carefully during installation since subjecting it to impact or other forces may cause product damage.
- Take care when fixing wall brackets to the wall. Always ensure that there are no electrical cables or pipes in the wall before hanging bracket.
- To prevent fall and injury, remove the TV from its fixed wall position when it is no longer in use.

Basic Connection

External equipment and cables shown are not supplied with this TV.

Please ensure that the unit is disconnected from the mains socket before attaching or disconnecting any leads.

When disconnecting the mains lead, be absolutely sure to disconnect the mains plug at the socket outlet first.

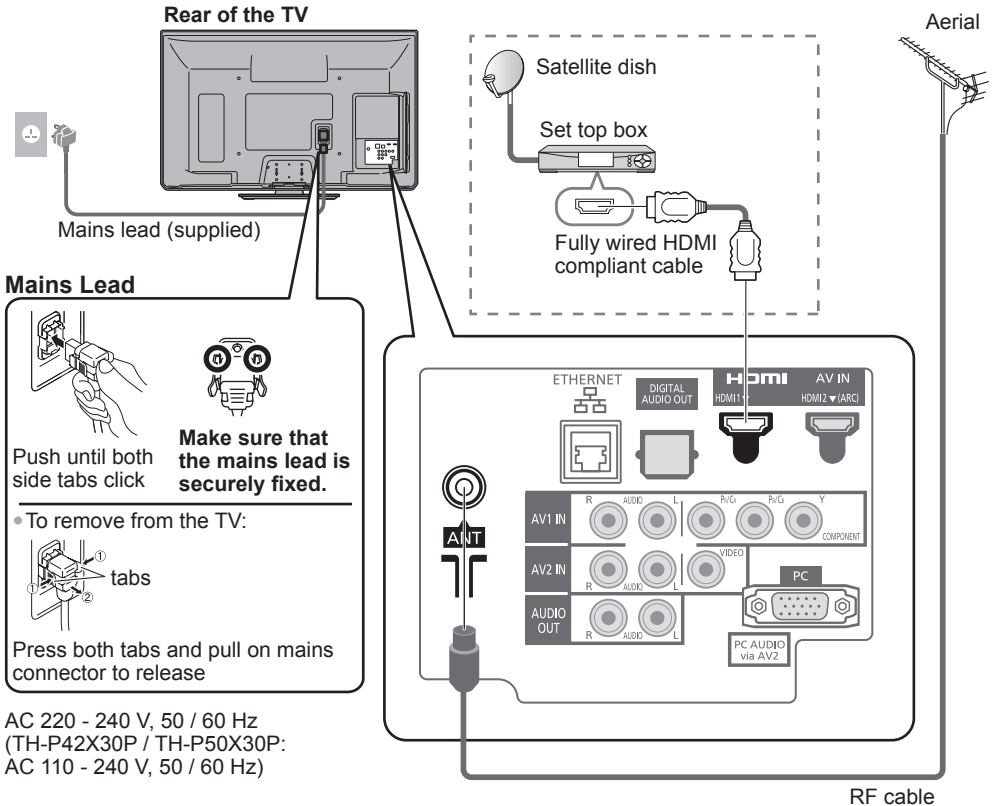

Note

- Keep RF (antenna) cable away from the mains lead to avoid and minimise mains interference pickup.
- Do not place the RF cable under the TV.
- To obtain optimum quality picture and sound, an aerial, the correct cable (75 Ω coaxial), and the correct terminating plug are required.
- If a communal aerial system is used, you may require the correct connection cable and plug between the wall aerial socket and the TV.
- Your local Television Service Centre or dealer may be able to assist you in obtaining the correct aerial system for your particular area and the accessories required.
- Any matters regarding aerial installation, upgrading of existing systems or accessories required, and the costs incurred, are the responsibility of you, the Customer.
- VIERA Link connection ➔ (p. 51)
- Other equipment connection ➔ (p. 56 - 58)
- Read the manual of the equipment, too.

Identifying Controls

TV

Identifying Controls



1 Function select

- [Volume] / [Contrast] / [Brightness] / [Colour] / [Sharpness] / [Tint] (NTSC signal) / [Bass] ([Music] or [Speech] mode in the Sound Menu) / [Treble] ([Music] or [Speech] mode in the Sound Menu) / [Balance] / [Auto Tuning]

2 Channel Up / Down, Value change (when using the F button), Switching the TV On (press either button for about 1 second when in Standby mode)

3 Changes the input mode

4 Headphones jack

5 USB 1/2 port

6 SD Card slot

7 HDMI3 terminal

8 AV3 terminals

9 Mains power On / Off switch

- Use to switch the mains power. If you turned the TV Off during Standby mode by the remote control last time, the TV will be in Standby mode when you turn the TV On with Mains power On / Off switch.

10 Remote control signal receiver

- Do not place any objects between the TV remote control signal receiver and remote control.

11 C.A.T.S. (Contrast Automatic Tracking System) sensor

- Senses brightness to adjust picture quality when [Eco Mode] in the Picture Menu is set to [On] → (p. 22)

12 Power LED

- Red : Standby
- Green : On
- When using the remote control, indicates the TV has received a command.

About the Operation Guide - On Screen Displays

The Operation Guide is displayed at the bottom of the on Screen Displays. The button used on this screen and manner of operation is displayed.

Example: [Media Player]

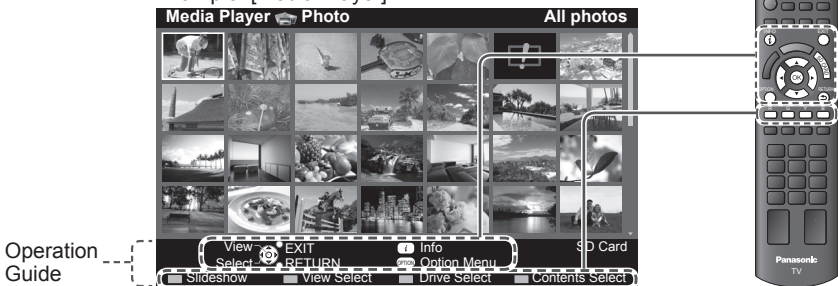

Remote Control

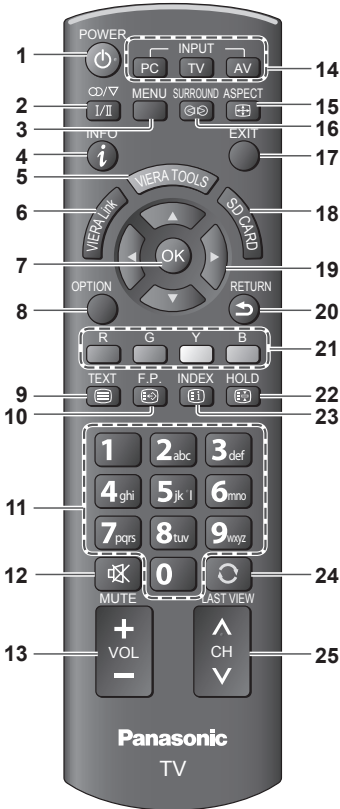

1 Standby On / Off switch

- Switches TV On or Off standby

2 Sound Selection

- Changes multiplex sound mode (if available) ➔ (p. 60)

3 [Main Menu] ➔ (p. 21)

- Press to access Picture, Sound and Setup Menus

4 Information ➔ (p. 15)

- Displays channel and programme information

5 VIERA TOOLS ➔ (p. 20)

- Displays some special feature icons and accesses easily

6 [VIERA Link Menu] ➔ (p. 53)

- Accesses VIERA Link Menu

7 OK

- Confirms selections and choices
- Press after selecting channel positions to quickly change programme

8 [Option Menu] ➔ (p. 15)

- Easy optional setting for viewing, sound, etc.

9 Teletext* ➔ (p. 17)

- Switches to teletext mode

10 Favourite Page* ➔ (p. 17)

- Calls up the teletext page stored in blue button.

11 Numeric buttons

- Changes channel and teletext pages
- When in Standby mode, switches TV On

12 Sound Mute

- Switches sound mute On or Off

13 Volume Up / Down

14 Input mode selection

- PC - switches to PC input mode ➔ (p. 19)
- TV - switches to TV mode ➔ (p. 14)
- AV - switches to AV input mode from Input Selection list ➔ (p. 19)

15 Aspect ➔ (p. 16)

- Changes aspect ratio

16 Surround ➔ (p. 24)

- Switches surround sound setting

17 Exit

- Returns to the normal viewing screen

18 [Media Player] ➔ (p. 33)

- Switches to SD Card and USB device viewing / listening mode

19 Cursor buttons

- Makes selections and adjustments

20 Return

- Returns to the previous menu / page

21 Coloured buttons

- Used for the selection, navigation and operation of various functions

22 Hold

- Freeze / unfreeze picture ➔ (p. 14)

- Holds the current teletext page (teletext mode)* ➔ (p. 17)

23 Index* ➔ (p. 17)

- Returns to the teletext index page (teletext mode)

24 Last View ➔ (p. 15)

- Switches to previously viewed channel or input modes

25 Channel Up / Down

- Selects channel in sequence

* Some countries do not provide a teletext service

Auto Tuning

Search and store TV channels automatically.

- These steps are not necessary if the setup has been completed by your local dealer.

Auto Tuning



1

Plug the TV into mains socket and switch On



- You can now use the remote control to turn On the TV or switch the TV to Standby mode. (Power LED: On)

2

Select your language

OSD Language		
English	ภาษาไทย	العربية
中文	Tiếng Việt	فارسی
हिन्दी	Indonesia	Français



3

Select your area

Channel Plan
Asia/W.Europe
CIS/E.Europe
China
Hong Kong
NZ/Indonesia
CATV/Other



When selecting CATV / Other, press the OK button, and then select the Channel Plan from Indian CATV, South Africa, American System, American CATV or Japan.

Auto Tuning starts



- Auto Tuning will start to search for TV channels and store them. The sorted channel order depends upon the TV signal, the broadcasting system and reception conditions.

4

Set up the wireless LAN connection



- You can setup the wireless LAN connection later. → (p. 46)
- If you want to select [Yes] in this position. → (p. 13)

5

Select [Home]



Auto Tuning is completed

*Viewing environment mode

Home : Recommended mode for viewing at home. Select [Home] for optimal picture / power consumption. [Viewing Mode] is set as [Normal] (p. 22).

Shop : Demonstration mode to explain main features of this TV (for in-store display). [Viewing Mode] is set as [Dynamic] (p. 22).

To return to viewing environment selection mode if you selected [Shop]

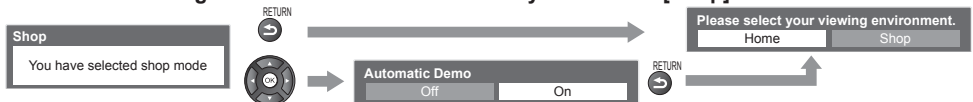

- To change viewing environment mode later on, reset all settings by accessing Shipping Condition. → [Shipping Condition] (p. 32)

Setup the wireless LAN connection

Setup the wireless LAN connection to enable the network service functions.

- To setup the wireless LAN connection, the wireless LAN Adaptor is required.
- Confirm the encryption key, settings and positions of your access point before starting setup. For details, read the manual of the access point.
- Please note that this TV does not support wireless public access points.

1 Connect the Wireless LAN Adaptor to the USB 1 or 2 port

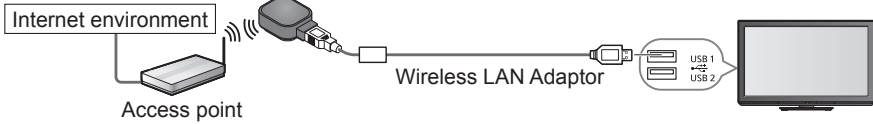

2 Select [Yes]

Start wireless LAN connection setup?

Yes No

Please connect the wireless LAN adaptor to a USB terminal.



3 Select the connection type

Connection Type

Please select network connection type.

WPS(Push button)
 Search for access point



- If your access point supports WPS (Push button), then select this option. If not, select [Search for access point].

■ [WPS(Push button)]

WPS(Push button)

1) Please press the 'WPS' button on the access point until its light flashes.

2) When the light is flashing select 'Connect' on TV.

If you are unsure, please check the instruction manual of the access point.

Press the WPS button on the access point until the light flashes. And then, press the OK button to connect the Wireless LAN Adaptor and the access point.



- Ensure that your access point supports WPS for this method.
- WPS: Wi-Fi Protected Setup™

■ [Search for access point]

Access points found automatically are listed.

No.	SSID	Wireless type	Encryp	Reception
1	Access Point A	11n(5GHz)	■	
2	Access Point B	11n(5GHz)	■	
3	Access Point C	11n(5GHz)	■	

1 Select your desired access point



- To search access points again
- For the information of the highlighted access point

2 Access the encryption key input mode



- If the selected access point is not encrypted, the confirmation screen will be displayed. It is recommended to select the encrypted access point.

3 Enter the encryption key of the access point (Set characters one by one)



- You can set characters by using numeric buttons.

4 Select [Yes]



- To re-enter the encryption key, select [No].

Encryption Key Setting

Connection will be made with the following settings:-
SSID : Access Point A
Authentication type : WPA-PSK
Encryption type : TKIP

Please input the encryption key.

Encryption key

Access Point Settings

Encryption key

A	B	C	D	E	F	G	H	I	J	K	L	M	N	O	P	Q	R	S	T
U	V	W	X	Y	Z	0	1	2	3	4	5	6	7	8	9	*	#		
a	b	c	d	e	f	g	h	i	j	k	l	m	n	o	p	q	r	s	t
u	v	w	x	y	z	[]	{	}	~									

Access Point Settings

Encryption key is set to:
XXXXXXXX

Select 'Yes' to confirm.
Select 'No' to change.

Yes No

Wireless LAN connection setup is completed



- If failed, check the encryption key, settings or positions of your access point. ➔ Read the manual of the access point.
- If connection to the access point is successful, we recommend you perform the [Connection Test] (p. 46).

Watching TV



1 Turn power on

2 Select TV mode

3 Select a channel

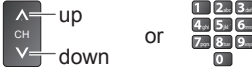

- Mains power On / Off switch should be On. (p. 10)

- To select the two-digit channel number, e.g. 35

3 **5** (in a short time)

- If one-digit channel number

(quickly changes the channel)

- When the TV is switched to standby, there will be a clicking sound after a short delay. This is normal.

Other useful functions

Hold

Freeze / unfreeze picture

HOLD



Off Timer

Turn the TV off automatically after a fixed period of time [Off / 15 / 30 / 45 / 60 / 75 / 90 minutes]

1 Display the menu **2 Select [Setup]** **3 Select [Off Timer] and set the time**

menu

MENU

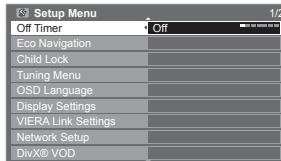
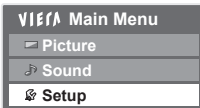

- To cancel ➔ Set to [Off] or turn the TV off.
- To display the remaining time ➔ "Display Information banner" (p. 15)
- When the remaining time is within 3 minutes, the remaining time will flash on screen.

Display Information banner

Display Information banner



• Also appears when changing a channel

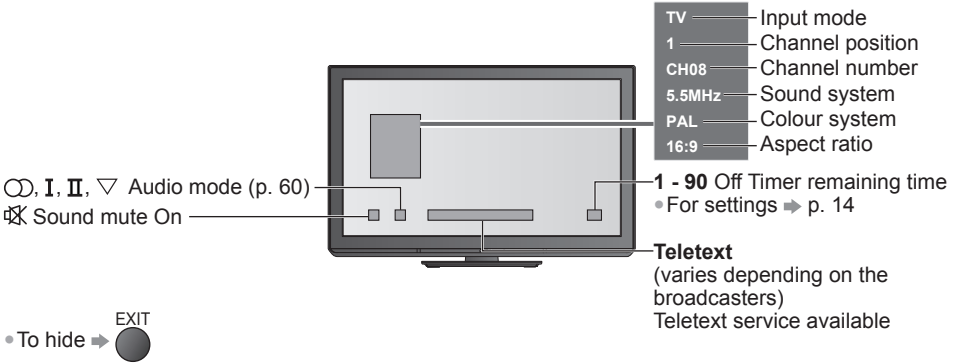

Display the selectable settings for the current programme

1 Check or change the current programme status instantly



2 Change



- ① select
- ② change

[Channel Colour Set]

Sets colour density → [Picture Menu] (p. 22)

[Teletext Character Set]

Sets the teletext language → [Setup Menu] (p. 27)

[MPX]

Selects multiplex sound (if available) → [Sound Menu] (p. 25)

[Volume Correction]

Adjusts the volume of an individual programme or input mode → [Sound Menu] (p. 24)

Last view

Switch to previously viewed channel or input mode easily



LAST VIEW

• Press again to return to the present view.

Note

- Switching channel is not available while Direct TV Recording is in progress.
- Watching less than 10 seconds is not regarded as the previously viewed channel or input mode.

Change aspect ratio

Enjoy viewing the image at its optimum size and aspect.

Press repeatedly until you reach the desired mode

ASPECT



■ If Aspect Selection list is displayed

1 Display Aspect Selection list

ASPECT

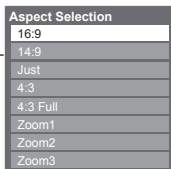

2 While the list is displayed, select the mode



① select

② change

[16:9]



Directly displays the image at 16:9 without distortion (anamorphic).

[14:9]

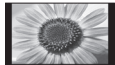

Displays the image at the standard 14:9 without distortion.

[Just]



Displays a 4:3 image full-screen. Stretching is only noticeable at the left and right edges.

[4:3]



Displays the image at the standard 4:3 without distortion.

[4:3 Full]



Displays a 4:3 image enlarged horizontally to fit the screen.
•HD signal only

[Zoom1]



Displays a 16:9 letterbox or 4:3 image without distortion.

[Zoom2]



Displays a 16:9 letterbox (anamorphic) image full-screen without distortion.

[Zoom3]



Displays a 2.35:1 letterbox (anamorphic) image full-screen without distortion. At 16:9, displays the image at its maximum (with slight enlargement).

Note

- Only [16:9] and [4:3] are available in PC input mode.
- Aspect is fixed to [16:9] when [Viewing Mode] is set to [Game] in the Picture Menu.
- Not available in teletext service.
- Aspect mode can be memorised separately for each SD (Standard definition) and HD (High definition) signals.

Change OSD language

You can change language for on screen displays.

1 Display the MENU

MENU

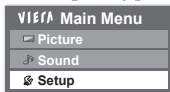

① select

② access

3 Select [OSD Language]

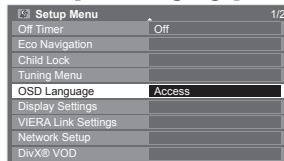

① select

② access

4 Select the language and set



① select

② set

Viewing Teletext

Teletext services are the text information provided by the broadcasters.

The features may vary depending on the broadcasters.

- Some countries do not provide this service

What is FASTEXT mode?

In FASTEXT mode, four differently coloured subjects are situated at the bottom of the screen. To access more information about one of these subjects, press the appropriately coloured button. This facility enables fast access to information on the subjects shown.

What is List mode?

In List mode, four differently coloured page numbers are situated at the bottom of the screen. Each of these numbers can be altered and stored in the TV's memory. ("Store frequently viewed pages" → p. 18)

- To change mode → [Teletext] in the Setup Menu (p. 27)



1 Switch to Teletext

- Displays the index page (content varies depending on the broadcasters)

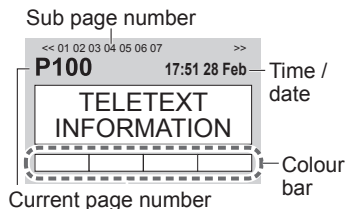

2 Select the page

- 1 2 3 up
 - 4 5 6 or [OK]
 - 7 8 9 down or [CH]
 - 0
- or [R] [G] [Y] [B] (Corresponds to the colour bar)

- To adjust contrast

MENU (press three times) → [OK] As the blue bar is displayed

- To return to TV [TEXT] or [EXIT]

Functions (Teletext mode)

HOLD

HOLD [HOLD] **Stop automatic updating**
(If you wish to hold the current page without updating)

- To resume [HOLD]

Reveal hidden data

MENU → [R] Reveal hidden words e.g. quiz page answers

- To hide [R]

INDEX

INDEX [INDEX] **Return to the main index page**

Call up a favourite page

F.P. [F.P.] **View a favourite page stored**
• Call up the page stored in "blue" (List mode).
• Factory setting is "103".

View in multi window

Watch TV and Teletext in two windows at once

MENU (press twice) →  Select Picture and text On or Off



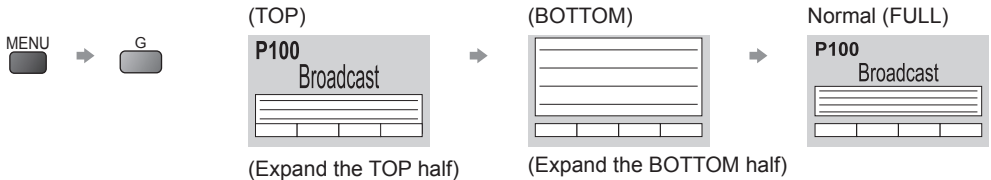

- Operations can be made only in Teletext screen.

FULL / TOP / BOTTOM



Store frequently viewed pages



Store frequently viewed pages in the colour bar (List mode only)

 Corresponding colour button (As page is displayed) →  press and hold

P100 Broadcast

101 200 400 888 — The number changes to white.

■ To change stored pages

 Coloured button you want to change →  Enter new page number →  press and hold

View sub page

View sub page (Only when teletext is more than one page)

 <<01 02 03 04 05 — Appears at top of the screen

■ To view specific sub page

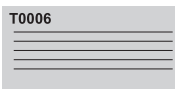
MENU → B →  Enter the 4-digit number example : P6 → 

0 0 0 6...

- Sub pages:



The number of sub pages varies depending on the broadcasters.

It may take some time for searching, during which time you can watch TV.

Watch TV while waiting for update

View the TV picture while searching for a teletext page

Teletext automatically updates itself when new information becomes available.

MENU → Y →  Appears when updating is completed →  View the updated page

Changes to TV screen temporarily (You cannot change the programme.)

- The news page provides a function that indicates arrival of latest news ("News Flash").

Watching External Inputs

Connect the external equipment (VCRs, DVD equipment, PC, etc.) and you can watch through the input.

- To connect the equipment ➔ (p. 9, 56 - 58)

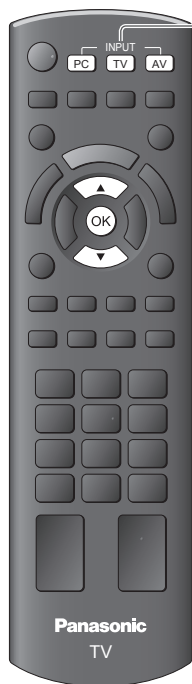

■ To return to TV



1 Display the input selection menu

When viewing PC ➔ **PC** (➔ skip to 3)

2 Select the input mode connected to the equipment

Example (AV2)

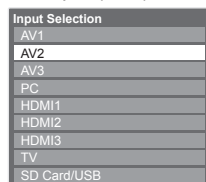

- You can also select the input using the AV button on the remote control or the side panel of the TV (p. 10). Press the button repeatedly until the desired input is selected.
- You can label or skip each input mode ➔ **[Input Labels]** (p. 31). Skipped inputs will not be displayed when the AV button is pressed.

3 View

Example (AV2)

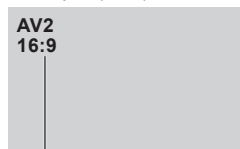

Displays the selected mode

- If the external equipment has an aspect adjustment function, set to [16:9].

Example (PC)

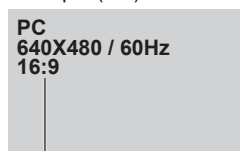

Displays the selected mode

- You can also listen to PC sound with the audio cable connected. To connect ➔ (p. 58)
- You can setup some functions ➔ PC Setup (p. 26) in the Setup Menu.
- For HDMI-compatible PC, possible to connect to HDMI terminals (HDMI1 / HDMI2 / HDMI3) by using HDMI cable (p. 61 - 62).

How to Use VIERA TOOLS

You can access some special features easily by using the VIERA TOOLS function.



1 Display icons of the feature

2 Select a feature



(example)

Internet contents

3 Follow the operations of each feature

[VIERA Link Control] → "VIERA Link Control" (p. 54)



When two or more compatible equipment are connected, a selection screen will be displayed. Please select the correct description and access.

[Photo]*

→ "Photo mode" (p. 35)



[Video]*

→ "Video mode" (p. 38)



[Music]*

→ "Music mode" (p. 41)



[Media Server]

→ "Using DLNA® features" (p. 47)



*When two or more available devices are connected, a selection screen will be displayed.

Please select the correct description and access.

Internet contents → "Accessing the Internet contents" (p. 50)
Part of Icons on VIERA TOOLS screen above provide you the usable Internet contents.

■ To return to TV

EXIT



OR



Note

- If the selected feature is not available, the demonstration to explain how to use it can be displayed. Press the OK button to view the demonstration after selecting the unavailable feature.

How to Use the Menu Functions

Various menus allow you to make settings for the picture, sound, and other functions.



1 Display the menu

- Displays the functions that can be set (varies according to the input signal)

2 Select the menu

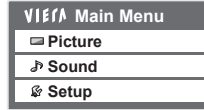

- For details → (p. 22)
- For details → (p. 24)
- For details → (p. 26)



3 Select the item



4 Adjust or select

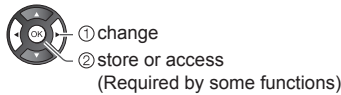

■ Choose from among alternatives

Number and positions of alternatives



Changed

■ Adjust using the slide bar



Moved

■ Go to the next screen



Displays the next screen

■ Enter characters by free input menu

You can enter names or numbers freely for some items.



Set characters one by one

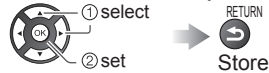

- To delete a character → R
- To delete all characters → B
- You can set characters by using numeric buttons.



Every press changes the character by one. Leave it for a second to set the character, or press OK or any numeric button within a second.

(Corresponding characters for each numeric button)

Numeric buttons	Characters	Numeric buttons	Characters
1	. ! : # + - * _ ()	6	m n o 6 M N O
2	a b c 2 A B C	7	p q r s 7 P Q R S
3	d e f 3 D E F	8	t u v 8 T U V
4	g h i 4 G H I	9	w x y z 9 W X Y Z
5	j k l 5 J K L	0	Space 0

■ To return to TV at any time



■ To return to the previous screen



■ To change menu pages

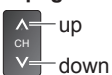

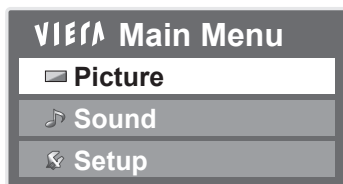

VIERA Main Menu

Picture

Sound

Setup

Note

- In each Viewing Mode and input, [Contrast], [Brightness], [Colour], [Sharpness], [Tint], [Colour Balance], [Vivid Colour], [Eco Mode], [P-NR] and [3D-COMB] can be adjusted and stored to suit your particular viewing requirement.
- Set for each input signal.

Item	Adjustments / Configurations (alternatives)
Viewing Mode <ul style="list-style-type: none"> • Dynamic • Normal • Cinema • True Cinema • Game 	Basic picture mode [Dynamic]: Provides enhanced picture contrast and sharpness when viewing in a bright room. [Normal]: Recommended for viewing under normal ambient room lighting conditions. [Cinema]: For watching movies in a darkened room with improving the performance of contrast, black and colour reproduction [True Cinema]: Precisely reproduces the original quality of the image without any revision. [Game]: Fast response signal specifically to provide suitable images for playing games <ul style="list-style-type: none"> • Not valid on TV mode • A continuous record of time spent using Game mode can be displayed in the top right of the screen. ➔ [Playing Time Display] (p. 27)
Contrast	Increases or decreases the levels of these options according to your personal preference
Brightness	
Colour	
Sharpness	
Tint	The picture hue can be adjusted to suit your taste <ul style="list-style-type: none"> • For NTSC signal, Component or HDMI input
Colour Balance <ul style="list-style-type: none"> • Cool • Normal • Warm 	Allows you to set the overall colour tone of the picture <ul style="list-style-type: none"> • Not valid when [Viewing Mode] is set to [True Cinema].
Channel Colour Set	Colour density varying between broadcast channels can be adjusted to three levels for each reception channel <ul style="list-style-type: none"> • Select the channel you want to adjust and set this function.
Vivid Colour <ul style="list-style-type: none"> • Off • On 	Automatically adjusts colours to vivid ones <ul style="list-style-type: none"> • Not valid on PC signal.
Eco Mode <ul style="list-style-type: none"> • Off • On 	Automatically adjusts the screen brightness appropriately as the surrounding light level lowers to reduce the power consumption <ul style="list-style-type: none"> • Not available in shop mode (Dynamic picture mode)
P-NR <ul style="list-style-type: none"> • Off • Min • Mid • Max 	Picture Noise Reduction Automatically reduces unwanted picture noise and flicker noise in the contoured parts of a picture <ul style="list-style-type: none"> • Not valid on PC signal.
3D-COMB <ul style="list-style-type: none"> • Off • On 	Makes still or slow moving pictures look more vivid <ul style="list-style-type: none"> • Occasionally, while viewing still or slow moving pictures, colour patterning may be seen. Set to [On] to display sharper and more accurate colours. • For PAL or NTSC signal reception only • Not valid on Component, PC, HDMI and Media Player

Screen Display		<ul style="list-style-type: none"> • Off • On <p>Turns the screen off when you select [Off]</p> <ul style="list-style-type: none"> • The sound is active even if the screen turns off. • Press any buttons (except Standby) to turn the screen on. • This function is effective in reducing power consumption when listening to the sound without watching the TV screen. 	
Advanced Settings	White Balance*1	R-Gain	Adjusts the white balance of bright red area
		G-Gain	Adjusts the white balance of bright green area
		B-Gain	Adjusts the white balance of bright blue area
		R-Cutoff	Adjusts the white balance of dark red area
		G-Cutoff	Adjusts the white balance of dark green area
		B-Cutoff	Adjusts the white balance of dark blue area
		Reset to Defaults	Press the OK button to reset to the default White Balance
	Gamma*1	Gamma	<ul style="list-style-type: none"> • S Curve / 1.8 / 2.0 / 2.2 / 2.4 / 2.6 <p>Switches the gamma curve</p> <ul style="list-style-type: none"> • Please note the numerical values are reference for the adjustment.
		Reset to Defaults	Press the OK button to reset to the default Gamma
	Refresh Rate	<ul style="list-style-type: none"> • 50 Hz • 100 Hz <p>Changes the image processing of the panel (depending on the input signal)</p> <ul style="list-style-type: none"> • Set to [100Hz] normally 	
	Side Panel	<ul style="list-style-type: none"> • Off • Low • Mid • High <p>Increases the brightness of the side panel</p> <ul style="list-style-type: none"> • The recommended setting is [High] to prevent panel "image retention". 	
16:9 Overscan	<ul style="list-style-type: none"> • Off • On <p>[On]: Default - Image is overscanned by ~5% beyond the edge of the screen to hide edge video noise</p> <p>[Off]: Displays image in its original size including edge video noise such as lines, dashes, dots etc.</p> <ul style="list-style-type: none"> • Applicable for video signals when TV aspect is set to [16:9] • Memorised separately for SD and HD channels / signals 		
DVI Input Setting	<ul style="list-style-type: none"> • Normal • Full <p>Changes the black level in the image for HDMI input mode with DVI input signal manually</p> <ul style="list-style-type: none"> • When the DVI input signal from the external equipment, especially from PC, is displayed, the black level may not be suitable. In this case, select [Full]. • The black level for HDMI input signal will be adjusted automatically. • For HDMI input mode with DVI input signal only. 		
Pixel Orbiter	<ul style="list-style-type: none"> • Auto • On <p>Selects the mode for wobbling of the image to prevent panel "image retention"</p> <p>[Auto]: Automatically works only for the appropriate images and you rarely recognise the wobbling.</p>		
Scrolling Bar	<p>Scrolls the vertical bar to prevent panel "image retention"</p> <ul style="list-style-type: none"> • Press the OK button to start scrolling and press any buttons (except Standby) to exit this mode. 		
Reset to Defaults		Press the OK button to reset settings of Picture Viewing Mode to the default.	

*1 : PC input mode only

VIERA Main Menu

Picture

Sound

Setup



Item	Adjustments / Configurations (alternatives)
Mode <ul style="list-style-type: none"> • Music • Speech • User 	<p>Selects basic sound mode</p> <ul style="list-style-type: none"> • The selected mode affects all input signals. <p>[Music]: Improves sound quality for watching music videos, etc.</p> <p>[Speech]: Improves sound quality for watching news, drama, etc.</p> <ul style="list-style-type: none"> • In Music and Speech modes, you can adjust [Bass] and [Treble] settings, and those settings will be stored for each mode. <p>[User]: Adjusts the sounds manually by using the equaliser to suit your favourite sound quality.</p> <ul style="list-style-type: none"> • For the User mode, [Equaliser] will appear on the Sound Menu instead of [Bass] and [Treble]. Select the [Equaliser] and adjust the frequency. <ul style="list-style-type: none"> ➔ [Equaliser] (below)
Bass	Increases or decreases level to enhance or minimise lower, deeper sound output
Treble	Increases or decreases level to enhance or minimise sharper, higher sound output
Equaliser	<p>Adjusts the frequency level to suit your favourite sound quality</p> <ul style="list-style-type: none"> • This function is available when [Mode] is set to [User]. • Select the frequency and change the frequency level by using the cursor button. • If you want to enhance the bass sound, raise the level of the lower frequency. If you want to enhance the treble sound, raise the level of the higher frequency. • To reset the levels of each frequency to the default settings, select the [Reset to Defaults] by using the cursor button, and then press the OK button.
Balance	Adjusts the volume level of right and left speakers
Headphone Volume	Adjusts the volume of the headphones
Surround <ul style="list-style-type: none"> • Off • V-Audio • V-Audio Surround 	<p>Surround sound settings</p> <p>[V-Audio]: Provides a dynamic enhancer of width to simulate improved spatial effects</p> <p>[V-Audio Surround]: Provides a dynamic enhancer of width and depth to simulate improved spatial effects</p> <ul style="list-style-type: none"> • Switching is also possible by the Surround button on the remote control (p. 11).
Volume Control (VAO) <ul style="list-style-type: none"> • TV • Audio Out (TV Off) • TV and Audio Out 	<p>Selects to adjust the volume of the audio output</p> <p>[TV]: Only the volume of TV speakers is adjustable.</p> <p>[Audio Out (TV Off)]: Only the volume of Audio Out is adjustable and mute the TV speaker's volume.</p> <p>[TV and Audio out]: the volume of TV speakers and Audio Out is adjustable.</p>
Auto Gain Control <ul style="list-style-type: none"> • Off • On 	Adjusts the current volume level if it is extremely different from the previous viewed channel or input mode
Volume Correction	Adjusts the volume of individual channel or input mode

Speaker Distance to Wall <ul style="list-style-type: none"> • Over 30cm • Up to 30cm 	Adjusts the low frequency sound <ul style="list-style-type: none"> • If the back space between the TV and wall is over 30 cm, [Over 30cm] is recommended. • If the back space between the TV and wall is within 30 cm, [Up to 30cm] is recommended.
MPX <ul style="list-style-type: none"> • Stereo • Mono • M1 • M2 	Selects multiplex sound mode (if available) <p>[Stereo]: Use this normally</p> <p>[Mono]: When stereo signal cannot be received</p> <p>[M1] / [M2]: Available while mono signal is transmitted</p>
SPDIF Selection <ul style="list-style-type: none"> • Auto • PCM 	SPDIF: A standard audio transfer file format Selects the initial setting for digital audio output signal from DIGITAL AUDIO OUT terminal <p>[Auto]: Dolby Digital is output as Dolby Digital Bitstream. HE-AAC and MPEG are output as PCM.</p> <p>[PCM]: Digital output signal is fixed to PCM.</p> <ul style="list-style-type: none"> • For Video mode (p. 38) or Network video contents (p. 48)
HDMI1 / 2 / 3 Input <ul style="list-style-type: none"> • Digital • Analogue 	Selects to fit the input signal (p. 61) <p>[Digital]: HDMI cable connection</p> <p>[Analogue]: HDMI-DVI adaptor cable connection</p> <ul style="list-style-type: none"> • HDMI input mode only
Reset to Defaults	Press the OK button to reset settings of the present [Mode], [Balance], [Headphone Volume] and [Surround] in the Sound Menu to the default

VIERA Main Menu

Picture

Sound

Setup

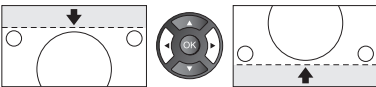

Item		Adjustments / Configurations (alternatives)
PC Setup	Input Resolution	Switches to a wide view <ul style="list-style-type: none"> VGA (640 × 480 pixels), WVGA (852 × 480 pixels), XGA (1,024 × 768 pixels), WXGA (1,280 × 768 pixels, 1,366 × 768 pixels) Options change depending on signals
	Clock	Sets to the minimum level if noise occurs.
	H-pos	 Adjusts horizontal position
	V-pos	 Adjusts vertical position
	Clock Phase	Eliminates flicker and distortion <ul style="list-style-type: none"> Adjust after Clock adjustment Set to the minimum level if noise occurs
	Sync <ul style="list-style-type: none"> H & V On Green 	PC sync signal type [H & V]: by the horizontal and vertical signals from your PC [On Green]: Sync on Green sync from your PC
	Reset to Default	Press the OK button to reset the PC Setup settings to the default.
Off Timer <ul style="list-style-type: none"> Off 15 / 30 / 45 / 60 / 75 / 90 minutes 	Sets the time until the TV automatically goes to Standby mode	
Eco Navigation	Automatically sets the TV to the most suitable energy-saving mode <ul style="list-style-type: none"> If you press the OK button, the following items are set as below: [Eco Mode], [VIERA Link], [Power off Link], [Standby Power Save], [Power Save] ➔ [On] [Intelligent Auto Standby] ➔ [On (No reminder)] [Auto Standby] ➔ [2 hours] 	
Child Lock	Locks a channel / AV input to prevent access to it (p. 30)	
Tuning Menu	Channel List Edit	Skips the unwanted channels or edits channels (p. 29)
	Auto Tuning	Sets all TV channels automatically (p. 29)
	Manual Tuning	Sets the TV channels manually (p. 29)
OSD Language <ul style="list-style-type: none"> English Thai Arabic China Vietnamese Persian Hindi Indonesia French 	Changes language for on screen displays	

Display Settings	Teletext • FASTEXT • List	Teletext display mode (p. 17) • Some countries do not provide a teletext service
	Teletext Character Set • English • CIS • E. Europe • Persian	Selects teletext language • Some countries do not provide a teletext service
	Input Labels	Labels or skips each input terminal (p. 31)
	Banner Display Timeout • 0 (No display) • 1 / 2 / 3 / 4 / 5 / 6 / 7 / 8 / 9 / 10 seconds	Sets how long the information banner stays on screen (p. 15)
	Playing Time Display • Off • On	Set to [On] to display a continuous record of time spent using Game mode every 30 minutes • This function is available when [Game] is selected in [Viewing Mode] (p. 22).
VIERA Link Settings	VIERA Link • Off • On	Sets to use VIERA Link functions • VIERA Link functions become available when [VIERA Link] is set to [On] (p. 52).
	Power on Link • Off • On	Sets to use Power on Link functions (p. 52)
	Power off Link • Off • On	Sets to use Power off Link functions (p. 52)
	Standby Power Save • Off • On	Controls the power consumption in Standby mode of the connected equipment to reduce the power consumption (p. 52) • This function is available when [VIERA Link] is set to [On] and [Power off Link] is set to [On].
	Intelligent Auto Standby • Off • On (With reminder) • On (No reminder)	Makes non-watched or non-used connected equipment go into Standby mode to reduce the power consumption (p. 52) • This function is available when [VIERA Link] is set to [On].
Network Setup		Sets the network setting to use in your network environment (p. 44)
DivX® VOD		Displays DivX VOD registration code (p. 65)
System Menu	Shipping Condition	Resets all settings to the original condition (p. 32)
	Software Licence	Displays the software licence information
	System Information	Displays the system information of this TV
Other Settings	Auto Standby • Off • 2 / 4 hours	Sets the time the TV automatically goes into Standby mode when no operation is performed for the selected times • Automatic input switching with the connected equipment affects this function and time-count will be reset. • The notification message will appear 3 minutes before going into Standby mode.
	Power Save • Off • On	Reduces brightness of the picture to economise on power consumption

- A different menu will be displayed in the mode of Media Player / Network service operations. (p. 33 - 50)
- Only available items can be selected.

Tuning and Editing Channels

You can make Auto Tuning, listing your favourite channels, skipping unwanted channels, etc.



Preparations:

1 Select TV Mode



2 Display the menu



3 Select [Setup]



1 Select [Tuning Menu]

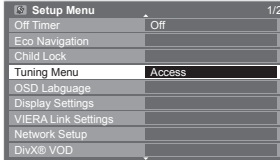

2 Select a function

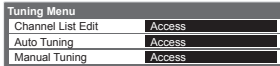

• For details → (p. 29)

■ To return to TV

EXIT



For Auto Tuning, using the buttons on the side panel of the TV (p. 10)

1 Press repeatedly until [Auto Tuning] appears



2 Access [Auto Tuning]



3 Start [Auto Tuning]



• To return to TV

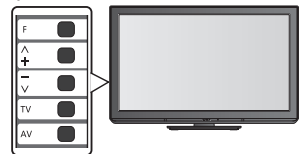

[Channel List Edit] - Skip unwanted channels / Edit Channels (Change name, Move)

You can hide unwanted channels. The hidden channels cannot be displayed except in this function. Use this function to skip unwanted channels.

Select a channel and reveal / hide

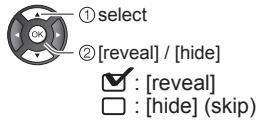
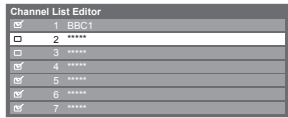

- To reveal all channels Y
- To retune each channel (Manual Tuning) R (see below)

■ To edit channels

You can also edit each channel in the Channel List. Select a channel to edit and:

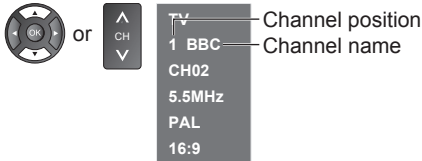

- To move the channel position

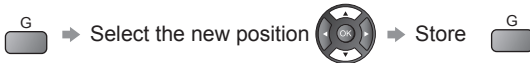

- To rename the channel name



Note

- If a VCR is connected only with the RF cable, edit [VCR].

[Auto Tuning] - Set all TV channels automatically

1 Start Auto Tuning

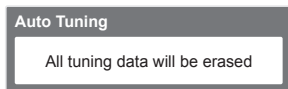

2 Settings are made automatically



Automatically retune all channels received in the area.

- All the previous tuning settings are erased.
- When the operation is completed, the channel at channel position [1] will be displayed.
- Search begins in the order from the lower channels to the higher channels.
- If tuning has not been done completely → **[Manual Tuning]** (see below)

[Manual Tuning] - Set TV channel manually

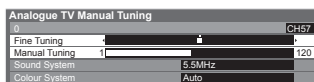

Fine Tuning

- Use to make small adjustments to the tuning of an individual channel (affected by weather conditions, etc.)

Manual Tuning

Set channel manually after Auto Tuning.

- Set Sound System and Colour System, and then perform this function. Set Colour System [Auto] normally.
- If a VCR is connected only with the RF cable, select channel position [0].

1 Select a channel position



2 Select a channel



3 Search and store



Child Lock

You can lock specific channels / AV input terminals and control who watches them. When the locked channel / input is selected, a message appears; by entering the PIN number, you can watch it.



■ To return to TV
EXIT

Preparations:

1 Display the menu



2 Select [Setup]



1 Select [Child Lock]

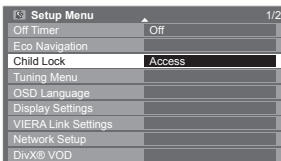

[Child Lock] - Control channel audience

1 Enter the PIN number (4 digits)



- Enter the PIN number twice at first setting.
- Make a note of the PIN number in case you forget it.

3 Select the channel / input to be locked

Name	Input	Type	Lock
2	TV	TV	🔒
3	TV	TV	🔒
AV1	External	AV	🔒
AV2	External	AV	🔒
AV3	External	AV	🔒
PC	External	AV	🔒
HDMI1	External	AV	🔒
HDMI2	External	AV	🔒



🔒 : Appears when the channel / input is locked

■ To change the PIN number

1 Select [Change PIN]



2 Enter a new PIN number twice.



2 Select [Child Lock List]



• To cancel → Select the locked channel / input



- To lock all
- To cancel all locks
- To jump to the top of the next input

Note

- Performing [Shipping Condition] (p. 32) erases the PIN number and all settings.

Input Labels

For easier identification and selection of the input mode, you can label each input mode or skip terminals that are not connected to any equipment.

- To select the input mode → (p. 19)



■ To return to TV
EXIT

■ User input

You can name each input mode freely.

1 Select [User input]



2 Set characters one by one



(maximum: ten characters)

- You can set characters by using numeric buttons.
- (p. 21)



3 Store



Preparations:

1 Display the menu



2 Select [Setup]



1 Select [Display Settings]

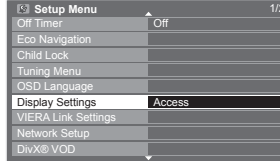

2 Select [Input Labels]



3 Select an input terminal and set

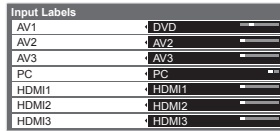

The labels you set will be displayed in [Input Selection] menu (p. 19) or banner.

- If [Skip] is selected, you cannot select the mode.

Shipping Condition (Reset settings)

Resets the TV to its original condition, i.e. no channels tuned in. All settings are reset (channels, picture, sound settings, etc.).



Preparations:

1 Display the menu



2 Select [Setup]



1 Select [System Menu]



2 Select [Shipping Condition]

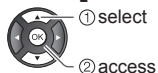

■ To return to TV



Shipping Condition (Reset settings)

[Shipping Condition] - Restore Settings

1 Check the message and reset

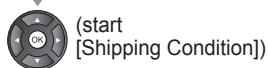
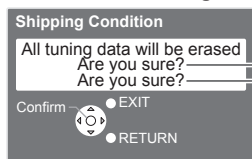

2 Follow the on screen instructions

Reset to Factory Shipping Condition Completed.
Please switch off TV.

- [Auto Tuning] will automatically start when Mains power On/Off switch is next turned on (p. 12).

■ To retune TV channels only, e.g. after moving house

➔ [Auto Tuning] in "Tuning and Editing Channels" (p. 29)

Using Media Player

Media Player allows you to enjoy photo, video or music recorded on an SD Card and a USB Flash Memory.

VIERA IMAGE VIEWER is the function of the easy viewing for photos or videos recorded on an SD Card on the TV screen by simply inserting into the SD Card slot.

Photo mode : Still pictures recorded by digital cameras will be displayed.

Video mode : Moving pictures recorded by digital video cameras will be played back.

Music mode : Digital music data will be played back.

When these functions are used, the audio signal is output from audio output terminals.

- [Date] shows the date on which the recording was made by the recording equipment. The file without record of the date is shown "****/**/****".
- The picture may not appear correctly on this TV depending on the recording equipment used.
- Display may take some time when there are many files and folders.
- Partly degraded files might be displayed at a reduced resolution.
- The folder and file names may be different depending on the digital camera or digital video camera used.

To insert or remove the SD Card / USB Flash Memory

■ USB Flash Memory

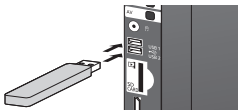

- Insert or remove straightly and completely.



■ SD Card

To insert the SD Card

Gently insert the SD Card label surface facing front.

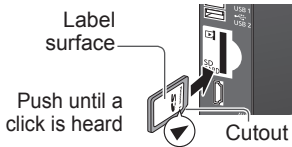

To remove the SD Card

Push the centre of the card



- For more information of the SD Card, USB Flash memory and supported file format ► (p. 63 - 64)

Starting Media Player



1 Insert the SD Card or USB Flash Memory

➔ (p. 33)

When the SD Card is inserted, switching to Media Player will be done automatically.



2 Switch to Media Player

3 Select the icon you want to access



- ① select
- ② access
- If only one device is connected, this step will be skipped.

selected device name

4 Select the content

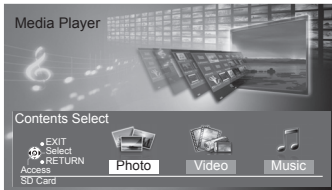

- ① select
- ② access
- [Photo] ➔ "Photo mode" (p. 35)
- [Video] ➔ "Video mode" (p. 38)
- [Music] ➔ "Music mode" (p. 41)

- You can also access each mode directly by using VIERA TOOLS. ➔ "How to Use VIERA TOOLS" (p. 20)

■ To return to TV



■ To return to the previous screen



Change the device

You can change to the other device directly in the same mode if two or more devices are connected.

1 Display the menu



selected device name

Photo mode

Supported file format → (p. 63)

The thumbnail of all the photos in the SD Card or USB Flash Memory will be displayed.

Example : Thumbnail - [All photos]

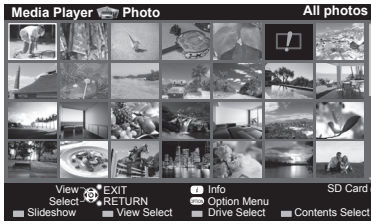

- To change the number of photos on a thumbnail screen at a time (7 × 4 ↔ 10 × 6)

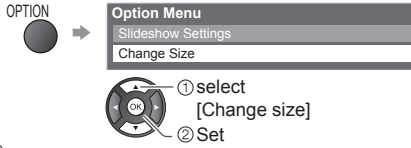

: Error display Selected Device Name

- To change the background music → “Photo Setup” (p. 36)
- To display the information of the highlighted photo

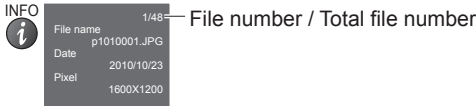

■ To sort by folder, recorded date or recorded month

1 Display the view selection



2 Select the sort type

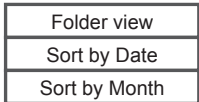

[Folder view] :

Displays the thumbnail grouped by folder

- The files which are not into a folder will be collected to the folder named “/”.

[Sort by Date] :

Displays the thumbnail grouped by the same date

- The group of the photos without a recorded date is shown as [Unknown].

[Sort by Month] :

Displays the thumbnail grouped by the same month

- The group of the photos without a recorded date is shown as [Unknown].



3 Select one of the sorted groups to display the thumbnail of the selected group

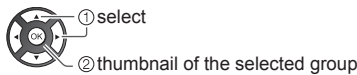
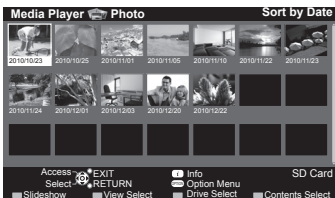

- To return to the thumbnail of all photos



- To display the information of the highlighted group

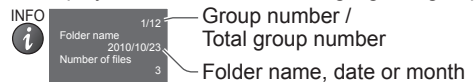

[Single view] - Photos are displayed one at a time.

Select the file from the thumbnail of photos to be viewed



Example :



Operation guide

• To display / hide the operation guide



• To return to thumbnail



• To operate Single view

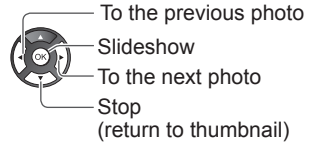

• To rotate 90°



[Slideshow] - Slideshow will complete when all photos have been viewed within the present thumbnail.

- 1 Select the file from the thumbnail of photos for the first view** **2 Start Slideshow**



• To display / hide the operation guide



• To pause (return to Single view)



• To return to thumbnail



Photo Setup

Setup the settings for Photo mode.

1 Display the option menu



2 Select [Slideshow Settings]





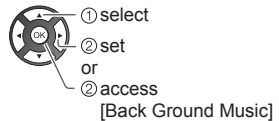
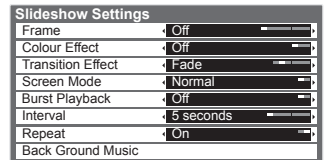

3 Select the items and set

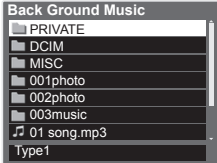

Note

- Picture quality may become lower depending on the slideshow settings.
- Picture setting may not work depending on the slideshow settings.

Item	Adjustments / Configurations (alternatives)
Frame	<p>Selects the indication frame of the slideshow [Off] / [Multi] / [Collage] / [Drift (+ calendar)] / [Drift] / [Gallery (+ calendar)] / [Gallery] / [Cinema] [Multi]: 9 division display like tiled design [Collage]: A photo is displayed at a random position and at a random scale. [Drift (+ calendar)] / [Drift]: Photos are displayed like flow images. <ul style="list-style-type: none"> You can select to display the calendar or not. To change the month of the calendar, press the left or right cursor button while viewing the slideshow. [Gallery (+ calendar)] / [Gallery]: The various sizes of photos in the frame are displayed. <ul style="list-style-type: none"> You can select to display the calendar or not. To change the month of the calendar, press the left or right cursor button while viewing the slideshow. [Cinema]: Photos are displayed like old films (sepia tone)</p>
Colour Effect	<p>Selects the colour effect of photos on Single view and Slideshow [Off] / [Sepia] / [Gray scale] <ul style="list-style-type: none"> This function is not available when [Frame] is set to [Drift], [Gallery] or [Cinema]. </p>
Transition Effect	<p>Selects the transition effect for switching the photo during the slideshow [Off] / [Fade] / [Slide] / [Dissolve] / [Motion] / [Random] [Fade]: The next photo fades in gradually. [Slide]: The next photo slides and appears from the left side. [Dissolve]: The photo is replaced by an indefinite block unit. [Motion]: The photo is replaced with enlarged, reduced, moved up or moved down. [Random]: Each transition is selected at random. <ul style="list-style-type: none"> This function is available when [Frame] is set to [Off]. </p>
Screen Mode	<p>Selects enlarged or normal viewing on Single view and Slideshow [Normal] / [Zoom] <ul style="list-style-type: none"> This function is not available when [Frame] is set to [Collage], [Drift], [Gallery] or [Cinema]. This function is not available when [Transition Effect] is set to [Motion]. Depending on the photo size, the photo may not be enlarged. </p>
Burst Playback	<p>Selects whether the continuous shots are displayed in rapid interval during the slideshow [Off] / [On] <ul style="list-style-type: none"> This function is not available when [Frame] is set to [Drift], [Gallery] or [Cinema]. This function is not available when [Transition Effect] is set to [Motion]. </p>
Interval	<p>Selects slideshow interval [5] / [10] / [15] / [30] / [60] / [90] / [120] (seconds) <ul style="list-style-type: none"> This function is not available when [Transition Effect] is set to [Motion]. </p>
Repeat	<p>Slideshow repeat [Off] / [On]</p>
Back Ground Music	<p>Selects the background music during Photo mode [Off] / [Type1] / [Type2] / [Type3] / [User] / [Auto] <ul style="list-style-type: none"> [Type1], [Type2] and [Type3] are the fixed music each installed in this TV. [User]: Music data in the current device registered by yourself will be played back. <p>To register the music</p> <p>1 Select the music file</p> <p>Depending on the conditions of the current device, select folders until you reach the desired music file.</p>  <p>2 Select [File] or [Folder]</p>   <p>① select ② set</p> <p>[File]: The selected music file will be registered as background music. [Folder]: All the music in the folder which contains the selected music file will be registered as background music.</p>  <p>① select ② access</p> <ul style="list-style-type: none"> If no music has been registered or the registered music device is removed, no sound will be produced. <p>[Auto]: Music data stored in the root folder of the current device will be played back randomly. <ul style="list-style-type: none"> If there is no available music data, no sound will be produced. </p> </p>

Change the contents

You can switch to the other mode of Media Player from the thumbnail view.

1 While the thumbnail is displayed, display the contents selection



2 Select the contents

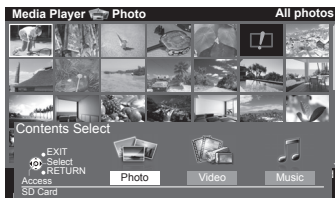

[Photo] ➔ **“Photo mode”** (p. 35)
 [Video] ➔ **“Video mode”** (below)
 [Music] ➔ **“Music mode”** (p. 41)

Video mode

Supported file format ➔ (p. 64)

The thumbnail of video titles in the SD Card or USB Flash Memory will be displayed.

Example : Thumbnail - [Title view]



The preview will start when the title is highlighted if it supports a preview.

- To turn off the preview
➔ **“Video Setup”** (p. 39)
- To display the information of the highlighted title

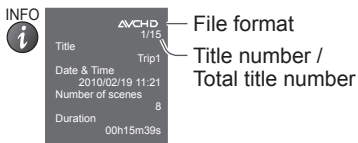

: Error display

: The file does not support thumbnail view.

- To view the scenes of the title

Select the title

Example : Thumbnail - [Scene view]

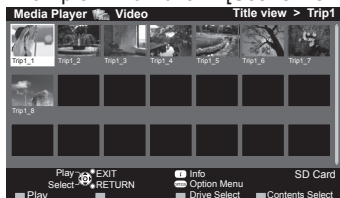

The preview will start when the scene is highlighted if it supports a preview.

- To turn off the preview
➔ **“Video Setup”** (p. 39)
- To display the information of the highlighted scene

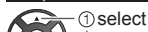
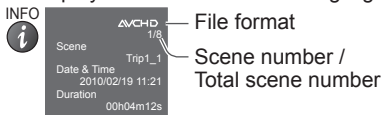

■ Playback from Title view

Playback of the selected title will start.

- To repeat playback ➔ **“Video Setup”** (p. 39)

1 Select the title



2 Start playback



■ Playback from the selected scene in the title

Playback will start from the selected scene to the end of the title.

- To repeat playback ➔ **“Video Setup”** (p. 39)

1 Select the title



2 Select the scene



3 Start playback



Note

- 38 • The structure of titles and scenes may vary depending on the digital video camera used.

■ How to operate playback

Example : Playback

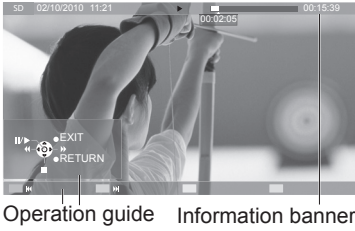

• To display / hide the operation guide and information banner



• To operate playback

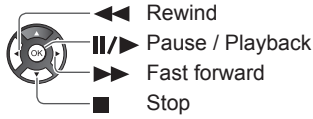

• To change aspect



• To the previous title / scene



• To the next title / scene



• To return to thumbnail



■ To change the content → “Change the contents” (p. 38)

Video Setup

Setup the settings for Video mode.

1 Display the option menu in the thumbnail view



access

3 Select the items and set

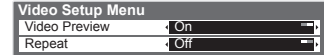

① select
② set

Item	Adjustments / Configurations (alternatives)
Video Preview	Sets to start the preview of the title or scene in the thumbnail view [Off] / [On] • Image may not be displayed for an instant in the thumbnail view. Set the preview [Off] to resolve this.
Repeat	Playback repeat within the title [Off] / [On] Only the selected file will be repeated.

Confirm or change the current status

You can confirm or change the current status of the content.

• Menu items and selectable options vary depending on the content.

1 Display the option menu during playback



access

3 Select the items and set



① select
② set

Item	Adjustments / Configurations (alternatives)
Multi Audio	Allows you to select between selectable sound tracks (if available) • It may take several seconds to change the sound.
Subtitle	Turn the subtitle on / off and select subtitle file (if available) [Off] / [Subtitle 1] (/ [Subtitle 2] ...)
Subtitle text	Selects the font type, if the subtitles text are not displayed correctly. [Latin1] / [Latin2] / [Cyrillic] / [Turkish] / [Unicode] / [Chinese1] / [Chinese2] • Some subtitles text may not be displayed correctly.
Aspect Change	[Aspect1] : Displays the content full-screen [Aspect2] : Displays the content square [Original] : Displays the content original size • You can also change the aspect using the ASPECT button. • Aspect change may not work depending on the content.

Audio output Settings

You can enjoy the multi-channel sound via an amplifier connected to the DIGITAL AUDIO OUT terminal.

- To confirm or change the current sound status ➔ **“Confirm or change the current status” (p. 39)**

1 Display the menu



2 Select [Sound]

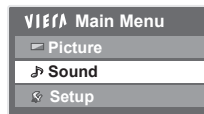

3 Select [SPDIF Selection] and set

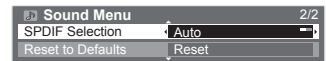

Item	Adjustments / Configurations (alternatives)
SPDIF Selection	SPDIF: A standard audio transfer file format Selects the initial setting for digital audio output signal from DIGITAL AUDIO OUT terminal [Auto] / [PCM] [Auto] : Dolby Digital is output as Dolby Digital Bitstream. MPEG is output as PCM. [PCM] : Digital output signal is fixed to PCM.

Music mode

Supported file format ➔ (p. 64)

The thumbnail of music folders in the SD Card or USB Flash Memory will be displayed.

Example : Thumbnail - [Folder view]

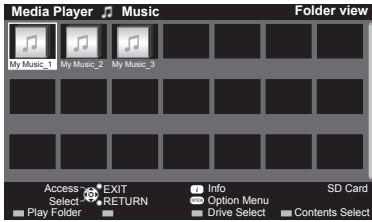

- To display the information of the highlighted folder
- | | | |
|-----------------|------------|-------------------------------------|
| INFO | 1/3 | Folder number / Total folder number |
| Folder name | My Music_1 | |
| Number of files | 11 | |

■ Playback from Folder view

All the files in the selected folder will be played back.

1 Select the folder



2 Start playback



■ Playback from File view

Selected file will be played back.

1 Select the folder



2 Select the file



3 Start playback



To display the information of the highlighted title

INFO	1/11	File number / Total file number
Title	My Song_1	
Album	My Music_1	
Artist	My Favorite	
Track No.	1	
Duration	00h03m29s	

■ How to operate playback

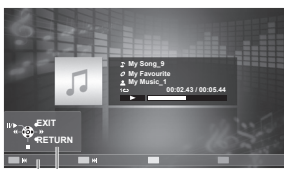

Operation guide

- To display / hide the operation guide
- To operate playback

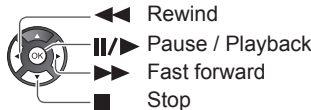

- To the previous track
- To the next track
- To return to thumbnail

Music Setup

Setup the setting for Music mode.

1 Display the option menu

OPTION

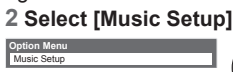

3 Set



[Folder]: Playback repeat within the selected folder

[One]: Playback repeat of the selected one file

Using Network Services

DLNA®

This TV is a DLNA Certified™ product.

DLNA (Digital Living Network Alliance) is a standard that makes DLNA Certified digital electronics easier and more convenient to use on a home network. To learn more, visit www.dlna.org.

It allows you to share photos, videos and music stored in a DLNA Certified media server (for example, PC with windows 7 installed (with suitable CODEC pack plug-in), DIGA Recorder etc.) connected to your home network, and enjoy them on the TV.

Supported file format ➔ (p. 63 - 64)

Media server

Ensure the connected equipment is a DLNA Certified media server.

To use a PC, install the server software on the PC for obtaining a media server.

Store photos, videos or music into the media server, and then you can watch them on the TV.

“TwonkyMedia server 6” and “Windows 7” are the server software that has been tested for the performance with this TV (current as of January, 2011).

For installing, read the manual of the server software.

- The DLNA control function of Windows 7 is not supported with this TV.
- When a server software for the media server is installed on the PC, the data may be at risk of being accessed by other people. Please take care of the settings and connections under the network circumstances at the office, hotel or even at home when not using a router.

By connecting a DLNA compatible DIGA Recorder to your home network, you can enjoy and control it as one of the media servers.

- For details, read the manual of the DIGA Recorder.

Network connection

➔ “Example 1” or “Example 2” in “Network connections” (p. 43)

Network setup

➔ (p. 44 - 46)

DLNA operations

➔ (p. 47 - 49)

Internet contents

You can access the Internet contents.

Network connection

➔ “Example 1” or “Example 3” in “Network connections” (p. 43)

Network setup

➔ (p. 44 - 46)

Enjoying the Internet contents

➔ (p. 50)

Network connections

To use only DLNA features, you can operate the features without a Broadband network environment. To enjoy the Internet contents, you need a Broadband network environment.

- If you do not have any Broadband network services, please consult your retailer for assistance.
- Confirm the terms and conditions of the contracts with your Internet Service Provider (ISP) or telecommunications company.
- Set up and connect any equipment required for the network environment.
- Required speed (effective): at least 1.5 Mbps for SD and 6 Mbps for HD picture quality, respectively. If the transfer speed is not enough, contents may not be played back properly.
- Read the manual of the network equipment, too.

Example 1

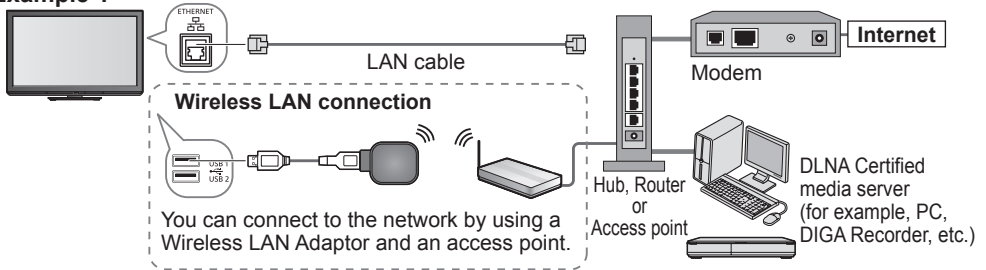

- Ensure to use a LAN straight cable for this connection.
- If your modem has no broadband router functions, use a broadband router.
- If your modem has broadband router functions but there are no vacant ports, use a hub.
- Ensure that the Broadband routers and hubs are compatible with 10BASE-T / 100BASE-TX.
- If you use the equipment compatible only with 100BASE-TX, category 5 LAN cables are required.

Example 2

You can connect the TV and the equipment directly to use DLNA features.

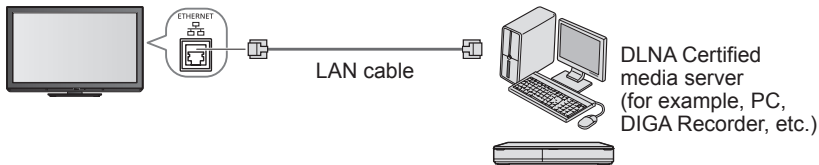

- Ensure to use a LAN cross cable for this connection.

Example 3

You can connect the TV and the telecommunication equipment directly to enjoy the Internet contents.

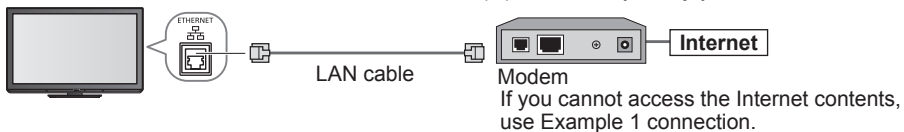

Note

- Depending on the ISP or telecommunications company, the required equipment and the internet connection procedure are different. Ensure that you use network equipment that is authorised by your ISP and telecommunications company.
- You cannot make settings for the network equipment on this TV. You may be required to make settings on your computer.
- Depending on the terms and conditions of the contracts with your ISP or telecommunications company, additional fees may be charged or multiple connections to the internet may be impossible.
- Please contact your ISP or telecommunications company if you require further assistance regarding the network equipment.

[Network Setup]

- Ensure the connections are completed before starting Network Setup.
→ “Network connections” (p. 43)



Preparations:

- 1 Display the menu



- 2 Select [Setup]



1 Select [Network Setup]

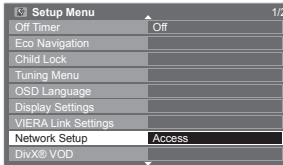

■ To return to TV

EXIT



Network settings for the LAN Cable connection

This setting is for the network connection by using the LAN cable.

1 Select [Network Type] and set to [Wired]

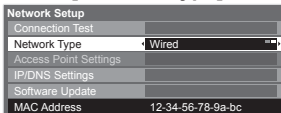

If you make the network connection like [Example2] (p. 43), you do not have to set [DNS Address], [Proxy] and [Proxy Port].

2 Select [IP/DNS Settings] and set the items

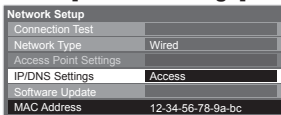

After settings, return to [Network Setup] screen



■ [Acquire IP Address]

■ [Acquire DNS Address]

Sets [IP Address], [Subnet Mask], [Gateway], [DNS Address] and [Proxy Settings].
For most users, the recommended method of connection to your network is by using [Auto] feature.

Select [Acquire IP Address] and then set to [Auto]

Select [Acquire DNS Address] and then set to [Auto]

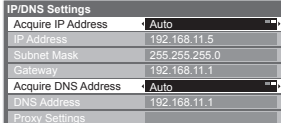

- The available settings are displayed automatically.

■ [Proxy Settings]

Select [Proxy Settings] and set the items

IP/DNS Settings	
Acquire IP Address	Auto
IP Address	192.168.11.5
Subnet Mask	255.255.255.0
Gateway	192.168.11.1
Acquire DNS Address	Auto
DNS Address	192.168.11.1
Proxy Settings	Access

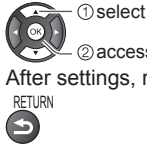

After settings, return to [Network Setup] screen

[Proxy]

Sets Proxy address.

- This is the address of the relay server that is connected to the target server instead of the browser and sends data to the browser. Setting is required if specified by the provider.

1. Select [Proxy]

Proxy Settings	
Proxy	
Proxy Port	0



2. Enter the address

Set characters one by one

Proxy																																																													
Host																																																													
<table border="1"> <tr><td>A</td><td>B</td><td>C</td><td>D</td><td>E</td><td>F</td><td>G</td><td>H</td><td>I</td><td>J</td><td>K</td><td>L</td><td>M</td><td>N</td><td>O</td><td>P</td><td>Q</td><td>R</td><td>S</td><td>T</td></tr> <tr><td>U</td><td>V</td><td>W</td><td>X</td><td>Y</td><td>Z</td><td>0</td><td>1</td><td>2</td><td>3</td><td>4</td><td>5</td><td>6</td><td>7</td><td>8</td><td>9</td><td></td><td></td><td></td><td></td></tr> <tr><td></td><td></td><td></td><td></td><td></td><td></td><td></td><td></td><td></td><td></td><td></td><td></td><td></td><td></td><td></td><td></td><td></td><td></td><td></td><td></td></tr> </table>		A	B	C	D	E	F	G	H	I	J	K	L	M	N	O	P	Q	R	S	T	U	V	W	X	Y	Z	0	1	2	3	4	5	6	7	8	9																								
A	B	C	D	E	F	G	H	I	J	K	L	M	N	O	P	Q	R	S	T																																										
U	V	W	X	Y	Z	0	1	2	3	4	5	6	7	8	9																																														



- You can set characters by using numeric buttons.

3. Store



[Proxy Port]

Sets Proxy port number.

- This number is also specified by the provider with the Proxy address.

1. Select [Proxy Port]

Proxy Settings	
Proxy	
Proxy Port	0



2. Move the cursor and enter the number

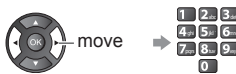

Select [Connection Test] and access to test

Network Setup	
Connection Test	Access
Network Type	Wired
Access Point Settings	
IP/DNS Settings	
Software Update	
MAC Address	12-34-56-78-9a-bc



- Performs automatic testing of the network connection for the TV. (It takes a while to test.)

Connection Test	
<input checked="" type="checkbox"/>	Check network cable connection.
<input checked="" type="checkbox"/>	Check acquired IP address.
<input checked="" type="checkbox"/>	Check for devices using same IP address.
<input checked="" type="checkbox"/>	Check gateway connection.
<input checked="" type="checkbox"/>	Check server connection.

: **succeeded**

The test is successful and the TV is connected to the network.

: **failed**

Check the settings and connections, and then perform this function again.

Network settings for the Wireless LAN connection

This setting is for the network connection by using a Wireless LAN Adaptor.

- Confirm the encryption key, settings and positions of your access point before starting setup.
For details, read the manual of the access point.

1 Select [Network Type] and set to [Wireless]

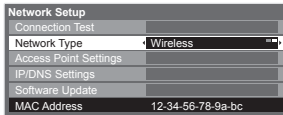

2 Select [Access Point Settings]

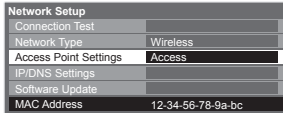

3 Select the connection type and set

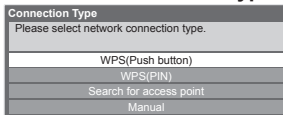

WPS(Push button) ➔ (p. 13)

WPS(PIN) : Sets by entering the PIN code to the access point

Search for access point ➔ (p. 13)

Manual : Sets manually by entering the SSID of access point

Follow the on screen instructions

4 Select [Connection Test] and access to test

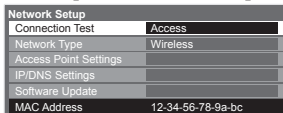

Performs automatic testing of the network connection for the TV.
(It takes a while to test.)

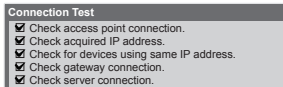

: **succeeded**

The test is successful and the TV is connected to the network.

: **failed**

Check the settings and connections, and then perform this function again.

If you continue to have difficulty, please contact your internet service provider.

Update TV's software

Accesses the specific web site to update TV's software and search if any software updates are available.

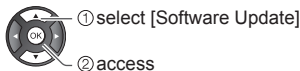
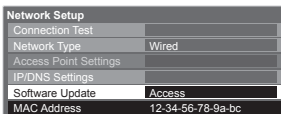

- Follow the on screen instructions

Note

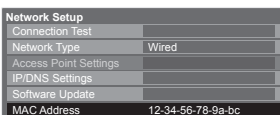

[MAC Address]

- MAC address is a unique address that identifies hardware in the network.
(for information only)

Using DLNA® features

- Ensure the preparation of the media server, network connections and network settings are completed.
 - ➔ “Media server” (p. 42), “Network connections” (p. 43), “Network Setup” (p. 44 - 46)



1 Display icons of the feature

2 Select [Media Server]



3 Select one of the media servers you want to access

Media server list

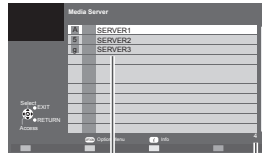

- To display the information of the highlighted media server

Available media servers



Total listed number

4 Select the file (photo or video) to be viewed

File list

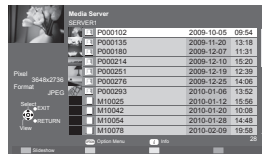

- Depending on the conditions of the media server, you may need to select the folder before selecting the file.
- Slideshow ➔ (p. 48)
- To display the information of the highlighted file



Note

- You may select and play back the music file.
- Non-playable files are also listed but cannot be selected.
- Turn the TV off, and then on again when changing or reconnecting the network connection.

- To return to TV EXIT



- To return to the previous screen RETURN





For photo file

[Single view] - Displayed one at a time





Operation guide

- To display / hide the operation guide 
- To operate Single view
 - ◀ To the previous photo
 - ▶ To the next photo
 - ⏮ Slideshow
 - ⏹ Stop (return to list)
- To rotate 90° 
- To return to the list 

[Slideshow] - Slideshow will be started from the selected photo file and completed within the list.

Start Slideshow 





- To display / hide the operation guide 
- To pause (return to Single view) 
- To return to the list 

For video file

Playback - Playback will start.



Operation guide

- To display / hide the operation guide and information banner 
- To operate playback
 - ◀◀ Rewind
 - [Manual skip]
 - (Skip to a fixed period forward manually for MPEG-2(PS format and TS format) only)
 - ⏸ Pause / Playback
 - ▶▶ Fast forward
 - ⏹ Stop
- To the previous content 
- To the next content 
- To change aspect 
- To return to the list 

For music file

Playback - Playback will start.

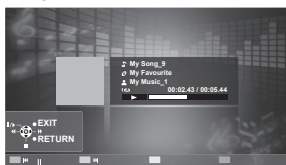

Operation guide





- To display / hide the operation guide 
- To operate playback
 - ◀◀ Rewind
 - ⏸ Pause / Playback
 - ▶▶ Fast forward
 - ⏹ Stop
- To the previous track 
- To the next track 
- To return to thumbnail 

Photo Setup (for photo contents)

Setup the settings for Photo.

1 Display the option menu
OPTION



2 Select [Slideshow Settings]



3 Select the items and set

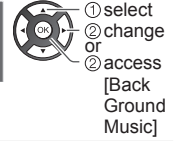
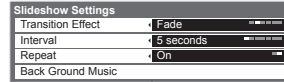

Item	Adjustments / Configurations (alternatives)
Transition Effect	Selects the transition effect for switching the photo during the slideshow [Off] / [Fade] / [Slide] / [Dissolve] / [Motion] / [Random] [Fade]: The next photo fades in gradually. [Slide]: The next photo slides and appears from the left side. [Dissolve]: The photo is replaced by an indefinite block unit. [Motion]: The photo is replaced with enlarged, reduced, moved up or moved down. [Random]: Each transition is selected at random.
Interval	Selects slideshow interval [5] / [10] / [15] / [30] / [60] / [90] / [120] (seconds)
Repeat	Slideshow repeat [Off] / [On]
Back Ground Music	Selects the background music while photo [Off] / [Type1] / [Type2] / [Type3] • [Type1], [Type2] and [Type3] are the fixed music each installed in this TV.

Audio output settings (for video contents)

You can enjoy the multi-channel sound via an amplifier connected to DIGITAL AUDIO OUT terminal.

1 Display the menu
MENU



2 Select [Sound]

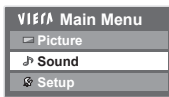

3 Select [SPDIF Selection] and set

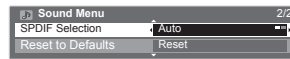

• For details
➔ (p. 40)

Video Setup (for video contents)

1 Display the option menu
OPTION



2 Select [Video Setup]



3 Select the items and set

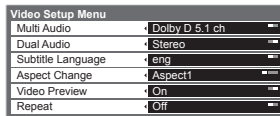

• For details ➔ (p. 39, 40)

Item	Adjustments / Configurations (alternatives)
Dual Audio	Selects multiplex sound (if available)
Subtitle Language	Allows you to select the language in which subtitles should appear (if available)

Music Setup

Setup the setting for Music mode.

1 Display the option menu
OPTION



2 Select [Music Setup]



3 Set



[Folder]: Playback repeat within the selected folder

[One]: Playback repeat of the selected one file

Accessing the Internet contents

This function allows you to access the Internet contents.

- Using this function requires a broadband internet connection. Dial-up internet connections cannot be used.
- Ensure the network connections and network settings are completed.
 - ➔ “Network connections” (p. 43), “Network Setup” (p. 44 - 46)



1 Display icons of the feature

2 Select the icon



■ To return to TV 

USB Keyboard

You can input characters by using a USB Keyboard connected to the USB port.

- You cannot use two or more keyboards simultaneously.
- A USB Keyboard which requires a driver is not supported.
- Characters may not be displayed correctly on the TV screen depending on the connected keyboard.

Note

- Be sure to update the software when a software update notice is displayed on the TV screen. If the software is not updated, you will not be able to enjoy this function.
You can update the software later manually ➔ [Software Update] in the Network Setup Menu (p. 46)
- The Internet contents are operated by their respective service providers, and service may be discontinued either temporarily or permanently without notice. Therefore, Panasonic will make no warranty for the content or the continuity of the services.
- All features of websites or content of the service may not be available.
- Some content may be inappropriate for some viewers.
- Some content may only be available for specific countries and may be presented in specific languages.
- Depending on the connection environment, the internet connection may be slow or may not be successful.
- Turn the TV off, and then on again when changing or reconnecting the network connection.
- Registration is required to access certain Internet contents. Refer registration steps shown on the screen when accessing Internet contents feature.

VIERA Link Functions

VIERA Link “HDAVI Control”™

Enjoy additional HDMI interoperability with Panasonic products which have “HDAVI Control” function. This TV supports “HDAVI Control 5” function.

Connections to equipment with HDMI cable such as a DIGA Recorder, HD Video Camera, Player theatre, Amplifier, etc., allow you to interface to them automatically.

These features are limited to models incorporating “HDAVI Control” and “VIERA Link”.

- Some functions are not available depending on the equipment’s version of HDAVI Control. Please confirm the connected equipment’s version of HDAVI Control.
- VIERA Link “HDAVI Control”, based on the control functions provided by HDMI which is an industry standard known as HDMI CEC (Consumer Electronics Control), is a unique function that we have developed and added. As such, its operation with other manufacturers’ equipment that supports HDMI CEC cannot be guaranteed.
- Please refer to individual manuals for the external equipment. About applicable Panasonic equipment, consult your local Panasonic dealer.

Summary of features

Connected equipment with VIERA Link function	DIGA Recorder*1	DVD Player / Blu-ray Disc Player*1	HD Video Camera / LUMIX Camera*1	Player theatre*2	Blu-ray Disc theatre*2	Amplifier*2
Channel download	○*4	—	—	—	—	—
Easy playback	○	○	○	○*7	○*7	—
Power on link	○	○	○	○	○	—
Power off link	○	○	○	○	○	○
Reduce unnecessary power consumption in standby	○*5	○*5	—	—	○*5	—
Auto standby for unnecessary equipment	○*3	○*3	—	○*3*8	○*3*8	○*3
Pause Live TV programme	○*4 *6	—	—	—	—	—
Direct TV Recording	○*4	—	—	—	—	—
Control the menu of the connected equipment by VIERA remote control	○*3	○*3	○*3	○*3	○*3	—
Speaker control	—	—	—	○	○	○

*1: HDMI Connection only

*2: HDMI and Audio out connections

*3: available with equipment which has “HDAVI Control 2 or later” function

*4: available with equipment which has “HDAVI Control 3 or later” function

*5: available with the equipment which has “HDAVI Control 4 or later” function

*6: available with DIGA Recorder which has HDD

*7: while playing a disc

*8: except for watching a disc

Connection

- To use DIGA Recorder / DVD Player / Blu-ray Disc Player / HD Video Camera / LUMIX Camera:

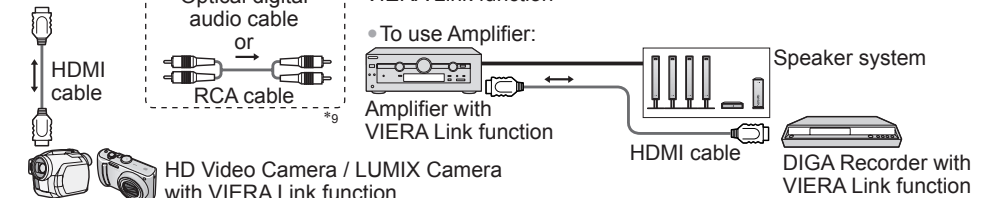
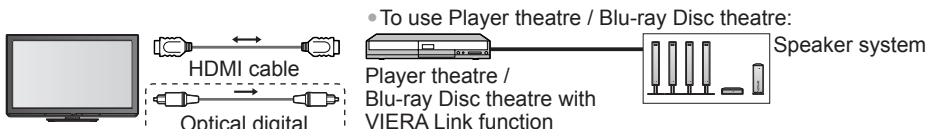
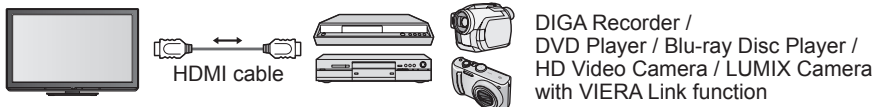

*9: If the connected equipment has “HDAVI Control 5” function, you do not have to use this audio cable (Optical digital audio cable or RCA cable). In this case, connect the equipment to the TV’s HDMI2 terminal via an HDMI cable.

Note

- For a DIGA Recorder / DVD Player / Blu-ray Disc Player / HD Video Camera / LUMIX Camera with VIERA Link function, connect to HDMI1, HDMI2 or HDMI3 terminal via an HDMI cable.
- For a Player theatre / Blu-ray Disc theatre / Amplifier, connect to HDMI1, HDMI2 or HDMI3 terminal via an HDMI cable, and also connect either the optical digital audio cable or RCA cable for audio output from the TV.
- Use fully wired HDMI compliant cable. Non-HDMI-compliant cables cannot be utilised.
A recommended Panasonic's HDMI cable part number:
 - RP-CDHS15 (1.5 m)
 - RP-CDHS30 (3.0 m)
 - RP-CDHS50 (5.0 m)

Preparations

- Connect the equipment supporting VIERA Link.
- Set up the connected equipment. Read the manual of the equipment.
- For optimal recording, the settings of the recorder may need to be changed. For details, read the manual of the recorder.
- Set [VIERA Link] [On] in the Setup Menu ➔ **[VIERA Link] (p. 27)**
- Set up the TV
 - ➔ **After connection, turn the equipment on and then switch the TV on.**
Select the input mode to HDMI1, HDMI2 or HDMI3 (p. 19), and make sure that an image is displayed correctly.

This setup should be done each time when the following conditions occur:

- for the first time
- when adding or reconnecting equipment
- when changing setup

Features available

Channel download

Channel settings can be downloaded to the recorder.

Easy playback

Automatic input switching - When connected equipment is operated, the input mode is switched automatically.

[Power on link]

Set Power on Link [On] in the Setup Menu to use this function ➔ [Power on Link] (p. 27)

When the connected equipment starts playback or direct navigator / function menu for the equipment are activated, the TV is automatically turned on. (Only when the TV is in Standby mode.)

[Power off link]

Set Power off Link [On] in the Setup Menu to use this function ➔ [Power off Link] (p. 27)

When the TV is set to Standby mode, the connected equipment is also automatically set to Standby.

- This function will work even if the TV enters Standby mode automatically by auto power standby function.

[Standby Power Save] - Reduce unnecessary power consumption in standby

Set Standby Power Save [On] in the Setup Menu to use this function ➔ [Standby Power Save] (p. 27)

The power consumption in Standby mode of the connected equipment is controlled higher or lower in synchronisation with the TV On / Off state to reduce the consumption.

When the TV is set to Standby mode, the connected equipment is automatically set to Standby and the power consumption in Standby mode of the connected equipment is automatically minimised.

When the TV is turned on, the connected equipment is still in Standby mode, but the power consumption is increased to make startup time early.

- This function is effective if the connected equipment can change the power consumption in Standby mode and is set to higher consumption.
- This function will work when [Power off Link] is set to [On].

[Intelligent Auto Standby] - Auto standby for unnecessary equipment

Set Intelligent Auto Standby [On (With reminder)] or [On (No reminder)] in the Setup Menu to use this function ➔ [Intelligent Auto Standby] (p. 27)

When the TV is On, non-watched or non-used connected equipment goes into Standby mode automatically to reduce the power consumption. For example, when the input mode is switched from HDMI, when Speaker Selection is changed to [TV] (except for watching a disc).

- If you select [On (With reminder)], the on screen message will be displayed to be noticed before working this function.
- This function may not work properly depending on the connected equipment. If required, set to [Off].

Features available (Using VIERA Link Menu)

[Pause Live TV]

You can pause the live TV programme and resume later.

Live TV programmes will be recorded on HDD of the connected DIGA Recorder.

- This function is available with a DIGA Recorder which has HDD.
- If you connect a variety of recorders including other manufacturers' recorders at the same time, please connect the DIGA Recorder which has a HDD to the TV's lower HDMI terminal number. For example, if you use HDMI1 and HDMI2 for two recorders, in this case connect DIGA Recorder which has HDD to HDMI1.
- If you cannot operate, check the settings and the equipment

➔ "Summary of features", "Connection", "Preparations" (p. 51 - 52)

Access and pause the live TV programme



1 Display [VIERA Link Menu]

2 Select [Pause Live TV] and pause

The TV picture will be paused.

VIERA Link Menu	
Pause Live TV	Start
Direct TV Rec	Start
VIERA Link Control	Recorder
Speaker Selection	Home Cinema



- The live TV programme is recorded on HDD from where it was paused.
- If the paused TV picture disappears after a few minutes,

➔  (the paused picture will be restored)

■ To operate Pause Live TV

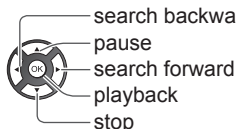

- Operations may be different depending on the recorder. In this case, follow the operation guide or read the manual of the recorder.

■ To return to Live TV

(stop playback of Pause Live TV / cancel pause)

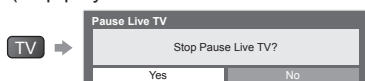

- If you stop playback or cancel pause, the recorded programme will be deleted from HDD.

[Direct TV Rec] - What you see is What you record

Recording the current programme in DIGA Recorder immediately.

- If you connect a variety of recorders including other manufacturers' recorders at the same time, please connect DIGA Recorder to the TV's lower HDMI terminal number. For example, if you use HDMI1 and HDMI2 for two recorders, in this case connect DIGA Recorder to HDMI1.
- If you cannot operate, check the settings and the equipment

➔ "Summary of features", "Connection", "Preparations" (p. 51 - 52)



1 Display [VIERA Link Menu]

2 Select [Direct TV Rec] and start recording

VIERA Link Menu	
Pause Live TV	Start
Direct TV Rec	Start
VIERA Link Control	Recorder
Speaker Selection	Home Cinema

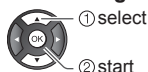

■ To stop recording

Select [Stop] in [Direct TV Rec] and stop recording

VIERA Link Menu	
Pause Live TV	Start
Direct TV Rec	Stop
VIERA Link Control	Recorder
Speaker Selection	Home Cinema



[VIERA Link Control] - Operate the connected equipment with VIERA remote control

You can control some functions of the connected equipment with this TV remote control by pointing at the TV's signal receiver.

- If you cannot operate, check the settings and the equipment
 - ➔ **“Summary of features”, “Connection”, “Preparations” (p. 51 - 52)**
- For details of the operations for the connected equipment, read the manual of the equipment.

Access and operate the menu of the equipment



1 **Display [VIERA Link Menu]**

2 **Select [VIERA Link Control]**

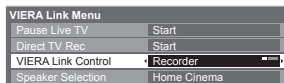

3 **Select the equipment you want to access**

The type of the connected equipment is displayed. Select the type of the equipment and access.



[Recorder] / [Player] / [Home Cinema] / [Video Camera] / [LUMIX] / [Digital Camera] / [Other]

- You can also access directly by using VIERA TOOLS ➔ (p. 20)
- The displayed item may vary depending on the connected equipment.
- [Home Cinema] means Player theatre, Blu-ray Disc theatre or Recorder theatre.
- [Other] means Tuner set top box.

The menu of the accessed equipment
(Input mode will be changed automatically)

4 **Operate the connected equipment**

• To display the operation guide



• Store / set / access



• Move the cursor / select the menu



• Return to the previous menu



• Move the cursor / access / adjust



• Exit the menu



When the key words are displayed on colour bar



Note

- Some operations may not be available depending on the equipment. If so, use its own remote control.

■ **If multiple recorders or players are connected** ■ **If you access non-VIERA Link equipment**

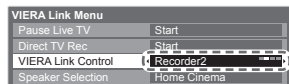

[Recorder1-3 / Player1-3]

The number is given from the TV's lower HDMI terminal number connected to the same type equipment. For example, two recorders to HDMI2 and HDMI3, in this case the recorder connected to HDMI2 is displayed as [Recorder1], and the recorder connected to HDMI3 is displayed as [Recorder2].

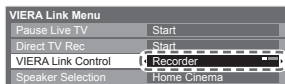

Type of the connected equipment is displayed.

You can access the menu of the equipment, but you cannot operate it. Use its own remote control to operate the equipment.

[Speaker Selection] - Speaker control

You can control the theatre speaker with this TV remote control by pointing at the TV's signal receiver.

• If you cannot operate, check the settings and the equipment

➔ “Summary of features”, “Connection”, “Preparations” (p. 51 - 52)

Access and control the speaker volume



1 Display [VIERA Link Menu]

2 Select [Speaker Selection]

VIERA Link Menu	
Pause Live TV	Start
Direct TV Rec	Start
VIERA Link Control	Recorder
Speaker Selection	Home Cinema



3 Set to [Home Cinema] or [TV]



[Home Cinema]

Player theatre, Blu-ray Disc theatre or Amplifier will be automatically turned on if it is in Standby mode and the sound is from theatre speakers connected to the equipment.

• Volume up / down 

• Mute 

• The sound of TV speakers is mute.

• When the equipment is turned off, TV speakers will be active.

[TV]

TV speakers are active.

Multi-channel sound

- If you wish to enjoy the multi-channel sound (e.g. Dolby Digital 5.1ch) via an Amplifier, connect with HDMI cable and Optical digital audio cable (p. 51), and then select [Home Cinema]. If your Amplifier has “HDAVI Control 5” function, you can connect only with HDMI cable. In this case, connect your Amplifier to the TV's HDMI2 terminal. To enjoy the sound from the DIGA Recorder in multi-channel sound, connect an HDMI cable from the DIGA Recorder to the Amplifier (p. 51).

Note

- These functions may not work properly depending on the connected equipment.
- Image or sound may not be available for the first few seconds when the Input mode is switched.
- Easy playback may be available by using the remote control for Player theatre, Blu-ray Disc theatre or Amplifier. Read the manual of the equipment.
- “HDAVI Control 5” is the newest standard (current as of December, 2010) for HDAVI Control compatible equipment. This standard is compatible with conventional HDAVI equipment.
- To confirm this TV's version of HDAVI Control ➔ [System Information] (p. 27)

External Equipment

These diagrams show our recommendations for connection of your TV to various pieces of equipment. For other connections, consult the instructions for each piece of equipment, the table below, and the specifications (p. 70).

Types of connectable equipment to each terminal

Equipment	Terminal					
	AV1 IN	AV2 IN	AV3 IN (Side panel of the TV)	AUDIO OUT	DIGITAL AUDIO OUT	HDMI 1 - 3
To play back videocassettes / DVDs (VCR / DVD Recorder)	<input type="radio"/>	<input type="radio"/>	<input type="radio"/>			*1 <input type="radio"/>
To watch DVDs (DVD Player)	<input type="radio"/>	<input type="radio"/>	<input type="radio"/>			<input type="radio"/>
To watch satellite broadcasts (Set top box)	<input type="radio"/>	<input type="radio"/>	<input type="radio"/>			<input type="radio"/>
To watch camcorder images (Video camera)	<input type="radio"/>	<input type="radio"/>	<input type="radio"/>			<input type="radio"/>
To play games (Game equipment)	<input type="radio"/>	<input type="radio"/>	<input type="radio"/>			<input type="radio"/>
To use amplifier with speaker system				<input type="radio"/>	<input type="radio"/>	*2 <input type="radio"/>
VIERA Link						<input type="radio"/>

Equipment	Terminal	
	ETHERNET	USB 1 - 2
To use Network services	<input type="radio"/>	<input type="radio"/>

- : Recommended Connection
 *1 : Only for DVD Recorder
 *2 : Use HDMI2 for connecting an amplifier. This connection is applicable when using an amplifier that has ARC (Audio Return Channel) function.

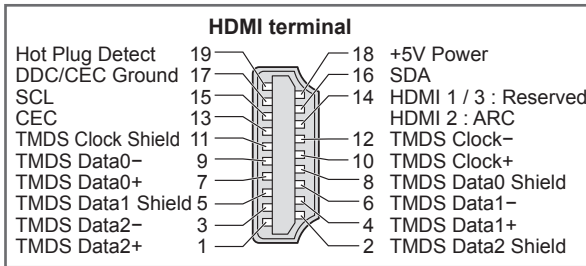

To play back

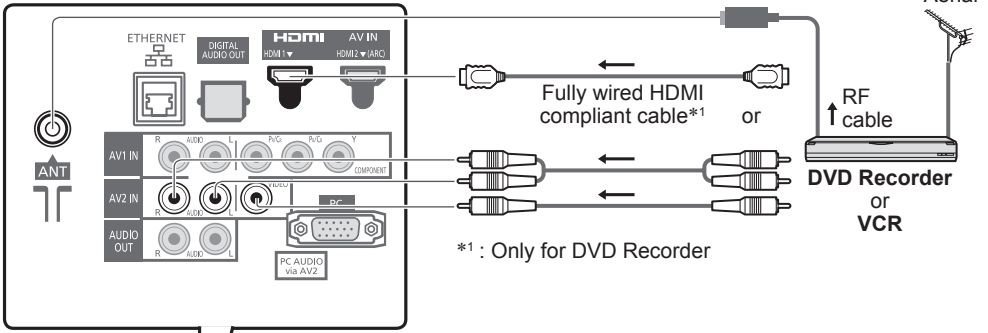

Rear of the TV

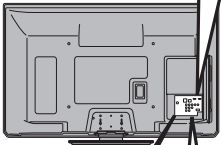

HDMI equipment

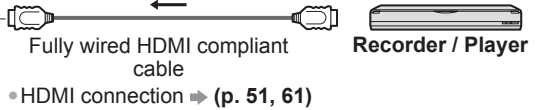

To watch DVDs

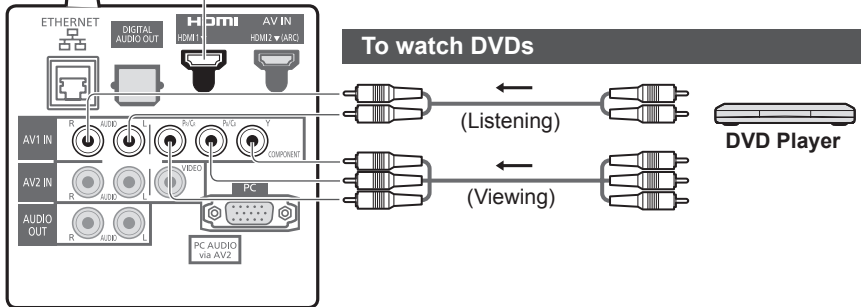

To listen with Home Theatre

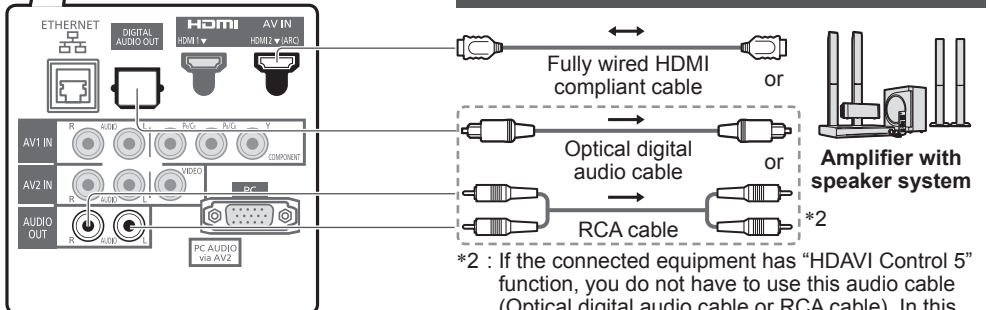

*2 : If the connected equipment has "HDAVI Control 5" function, you do not have to use this audio cable (Optical digital audio cable or RCA cable). In this case, connect the equipment to the TV's HDMI2 terminal via an HDMI cable.

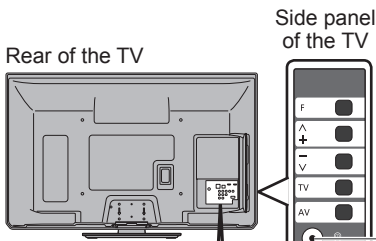

Headphones

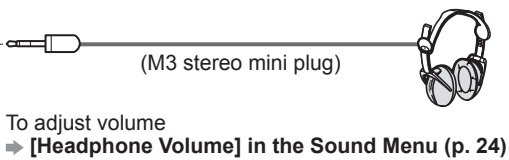

USB devices



Camcorder / HDMI equipment



Camcorder / Game equipment

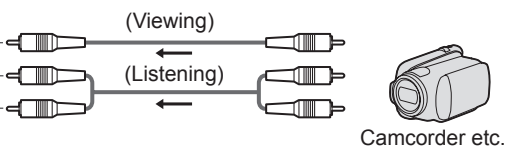

Network

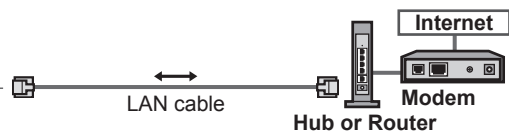

(TH-P42X30Q, (TH-P50X30Q)

Less than 10 cm

LAN cable

Less than 10 cm

Internet

Modem

Ferrite core (supplied)

Hub or Router

Installing the Ferrite core

- 1 Pull back the tabs (in two places)
- 2 Wind the cable twice
- 3 Press the cable through and close

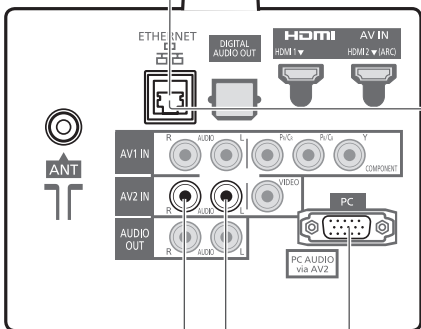

PC

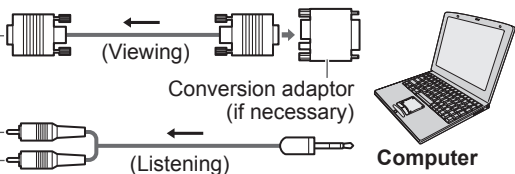

Technical Information

Channel Allocation





Channel Plan	Asia/ W. Europe	CIS / E. Europe	China	Hong Kong	NZ / Indonesia	Indian CATV	South Africa	American System	American CATV	Japan
CH DISPLAY	Receive channel									
0	-	-	-	-	-	-	-	-	-	-
1	-	1	1	-	-	1	1	-	1	1
2	2	2	2	-	2	2	2	2	2	2
3	⋮	⋮	⋮	-	⋮	⋮	⋮	⋮	⋮	⋮
4	⋮	⋮	⋮	-	⋮	⋮	⋮	⋮	⋮	⋮
5	⋮	⋮	⋮	-	⋮	S'1	⋮	⋮	⋮	⋮
6	⋮	⋮	⋮	-	⋮	S'2	⋮	⋮	⋮	⋮
7	⋮	⋮	⋮	-	⋮	S'3	⋮	⋮	⋮	⋮
⋮	⋮	⋮	⋮	-	⋮	S1	⋮	⋮	⋮	⋮
11	11	11	⋮	-	11	S2	11	⋮	⋮	⋮
12	12	12	12	-	-	S3	12	⋮	⋮	12
13	-	-	13	-	-	S4	13	13	⋮	13
14	-	-	-	-	-	⋮	-	14	⋮	-
15	-	-	-	-	-	⋮	-	-	⋮	-
16	-	-	-	-	-	⋮	-	-	⋮	-
⋮	-	-	-	-	-	⋮	-	-	⋮	-
19	-	-	-	-	-	S10	-	-	⋮	-
20	-	-	-	-	-	5	-	-	⋮	-
21	21	21	⋮	21	21	6	21	⋮	⋮	⋮
22	⋮	⋮	⋮	⋮	⋮	⋮	⋮	⋮	⋮	⋮
23	⋮	⋮	⋮	⋮	⋮	⋮	⋮	⋮	⋮	⋮
24	⋮	⋮	⋮	⋮	⋮	12	⋮	⋮	⋮	⋮
⋮	⋮	⋮	⋮	⋮	⋮	S11	⋮	⋮	⋮	⋮
28	⋮	⋮	⋮	⋮	⋮	⋮	⋮	⋮	⋮	⋮
⋮	⋮	⋮	⋮	⋮	⋮	S40	⋮	⋮	⋮	⋮
57	⋮	⋮	57	⋮	⋮	S41	⋮	⋮	⋮	⋮
58	⋮	⋮	-	⋮	⋮	21	⋮	⋮	⋮	⋮
59	⋮	⋮	-	⋮	⋮	⋮	⋮	⋮	⋮	⋮
62	62	62	-	62	62	24	62	62	62	62
63	63	63	-	63	63	25	63	63	63	C13
⋮	⋮	⋮	-	⋮	⋮	⋮	⋮	⋮	⋮	⋮
69	69	69	-	69	69	31	69	69	⋮	⋮
70	-	-	-	-	-	32	-	-	⋮	⋮
⋮	⋮	⋮	⋮	⋮	⋮	⋮	⋮	⋮	⋮	⋮
73	-	-	-	-	-	⋮	-	-	⋮	⋮
74	S'1	S'1	-	S'1	S'1	⋮	S'1	-	⋮	⋮
75	S'2	-	-	S'2	S'2	⋮	S'2	-	⋮	⋮
76	S'3	-	-	S'3	S'3	⋮	S'3	-	⋮	⋮
77	-	-	-	-	-	⋮	-	-	⋮	⋮
78	-	-	-	-	-	⋮	-	-	⋮	⋮
79	-	-	-	-	-	41	-	-	⋮	⋮
80	S1	S1	-	S1	S1	42	S1	-	⋮	⋮
81	S2	S2	Z1	S2	S2	⋮	S2	-	⋮	⋮
⋮	⋮	⋮	⋮	⋮	⋮	⋮	⋮	-	⋮	⋮
89	S10	S10	Z9	S10	S10	51	S10	-	⋮	⋮
90	S11	S11	Z10	S11	S11	52	-	-	⋮	⋮
91	S12	S12	Z11	S12	S12	⋮	-	-	⋮	⋮
92	S13	S13	Z12	S13	S13	⋮	-	-	⋮	⋮
93	S14	S14	Z13	S14	S14	⋮	S14	-	⋮	⋮
94	S15	S15	Z14	S15	S15	⋮	S15	-	⋮	⋮
95	S16	S16	Z15	S16	S16	⋮	S16	-	⋮	⋮
96	S17	S17	Z16	S17	S17	⋮	S17	-	⋮	⋮
97	S18	S18	Z17	S18	S18	⋮	S18	-	⋮	⋮
98	S19	S19	Z18	S19	S19	⋮	S19	-	⋮	⋮
99	S20	S20	Z19	S20	S20	61	S20	-	99	C49
100	S21	S21	Z20	S21	S21	62	S21	-	100	-
⋮	⋮	⋮	⋮	⋮	⋮	⋮	⋮	-	⋮	⋮
107	⋮	⋮	⋮	⋮	⋮	69	⋮	-	⋮	⋮
⋮	⋮	⋮	⋮	⋮	⋮	70	⋮	-	⋮	⋮
117	⋮	⋮	Z37	⋮	⋮	-	⋮	-	⋮	⋮
118	⋮	⋮	-	⋮	⋮	-	⋮	-	⋮	⋮
⋮	⋮	⋮	-	⋮	⋮	-	⋮	-	⋮	⋮
120	S41	S41	-	S41	S41	-	S41	-	⋮	⋮
⋮	⋮	⋮	-	⋮	⋮	-	⋮	-	⋮	⋮
125	-	-	-	-	-	-	-	-	125	-

Stereo / Bilingual Sound Selection



 When you receive the stereo / bilingual sound system, sound output modes can be selected by pressing the Sound Selection button.

Audio Signal	STEREO	MAIN I	SUB II	MONO
Mode Indicator		I	II	

NICAMUsed in New Zealand, Singapore, Hong Kong etc.

Type of broadcast	Regular broadcast (Standard Audio)	Regular + NICAM MONO I (MAIN I)	NICAM STEREO	NICAM DUAL MONO (MAIN I / SUB II)
Mode Indicator	No Indicator \leftrightarrow 	I \leftrightarrow 	 \leftrightarrow 	

A2 (German)Used in Australia, Malaysia etc.

Type of broadcast	Regular broadcast (Standard Audio)	BILINGUAL or DUAL MONO: MAIN I / SUB II	STEREO
Mode Indicator	No Indicator \leftrightarrow 	I \leftrightarrow II	 \leftrightarrow 

- If the stereo signal is poor or the receiving conditions are not optimum or if STEREO:MONO automatic switching occurs, it is recommended you switch from STEREO to MONO.
- Even when the contents of the receiving signal undergo changes, selection mode is kept intact.
- When the receiving conditions deteriorate, listening will be easier if the mode is set to the MONO position, using the Sound Selection button.
- DUAL, also known as DUAL MONO or as BILINGUAL is not currently transmitted in some countries.

HDMI connection

HDMI (high-definition multimedia interface) is the world's first complete digital consumer AV interface complying with a non-compression standard.

HDMI allows you to enjoy high-definition digital images and high-quality sound by connecting the TV and the equipment.

HDMI-compatible equipment*1 with an HDMI or DVI output terminal, such as a DVD player, a set top box or game equipment, can be connected to the HDMI terminal using an HDMI compliant (fully wired) cable.

About connections, see "External Equipment" (p. 56 - 58).

Applicable HDMI features

- Input audio signal : 2ch Linear PCM (sampling frequencies - 48 kHz, 44.1 kHz, 32 kHz)
- Input video signal : 480i, 480p, 576i, 576p, 720p, 1080i and 1080p
 - ➔ "Input signal that can be displayed" (p. 62)
 - Match the output setting of the digital equipment.
- Input PC signal : ➔ "Input signal that can be displayed" (p. 62)
- Match the output setting of the PC.
- VIERA Link (HDAVI Control 5) : ➔ [VIERA Link] (p. 51)
- Audio Return Channel*2 (HDMI2 terminal only)

DVI connection

If the external equipment has only a DVI output, connect to the HDMI terminal via a DVI to HDMI adaptor cable*3. When the DVI to HDMI adaptor cable is used, connect the audio cable to the audio input terminal (HDMI1 / 2: use AV2 audio terminals / HDMI3: use AV3 audio terminals).

Note

- Audio settings can be made on the [HDMI1 / 2 / 3 Input] in the Sound Menu. (p. 25)
- If the connected equipment has an aspect adjustment function, set the aspect ratio to [16:9].
- These HDMI connectors are "type A".
- These HDMI connectors are compatible with HDCP (High-Bandwidth Digital Content Protection) copyright protection.
- Equipment having no digital output terminal may be connected to the input terminal of "COMPONENT" or "VIDEO" to receive analogue signals.
- This TV incorporates HDMI™ technology.

*1: The HDMI logo is displayed on HDMI-compliant equipment.

*2: Audio Return Channel (ARC) is a function to be able to send digital sound signals via an HDMI cable.

*3: Enquire at your local digital equipment retailer shop.

PC connection

A PC may be connected to this TV so that the PC screen is displayed and sound is heard from the TV.

- PC signals that can be inputted: Horizontal scanning frequency 31 to 69 kHz; vertical scanning frequency 59 to 86 Hz (more than 1,024 signal lines could result in incorrect display of the image).
- A PC adaptor is not necessary for the DOS/V-compliant D-sub 15-pin connector.

Note

- Some PC models cannot be connected to this TV.
- When using PC, set the colour display quality of PC to the highest position.
- For details of the applicable PC signals, see p. 62.
- Max. display resolution

Aspect	4:3	768 × 768 pixels
	16:9	1,024 × 768 pixels

- D-sub 15-pin connector signal



Pin No.	Signal Name	Pin No.	Signal Name	Pin No.	Signal Name
①	R	⑥	GND (Ground)	⑪	NC (not connected)
②	G	⑦	GND (Ground)	⑫	NC (not connected)
③	B	⑧	GND (Ground)	⑬	HD
④	NC (not connected)	⑨	NC (not connected)	⑭	VD
⑤	GND (Ground)	⑩	GND (Ground)	⑮	NC (not connected)

Input signal that can be displayed

COMPONENT (Y, P_B/C_B, P_R/C_R), HDMI

○ Mark: Applicable input signal

Signal name	COMPONENT	HDMI
525 (480) / 60i	○	○
525 (480) / 60p	○	○
625 (576) / 50i	○	○
625 (576) / 50p	○	○
750 (720) / 60p	○	○
750 (720) / 50p	○	○
1,125 (1,080) / 60i	○	○
1,125 (1,080) / 50i	○	○
1,125 (1,080) / 60p		○
1,125 (1,080) / 50p		○
1,125 (1,080) / 24p		○

PC (from D-sub 15P)

Applicable input signal for PC is basically compatible to VESA standard timing.

Signal name	Horizontal frequency (kHz)	Vertical frequency (Hz)
640 × 400 @70 Hz	31.47	70.07
640 × 480 @60 Hz	31.47	59.94
640 × 480 @75 Hz	37.50	75.00
800 × 600 @60 Hz	37.88	60.32
800 × 600 @75 Hz	46.88	75.00
800 × 600 @85 Hz	53.67	85.06
852 × 480 @60 Hz	31.44	59.89
1,024 × 768 @60 Hz	48.36	60.00
1,024 × 768 @70 Hz	56.48	70.07
1,024 × 768 @75 Hz	60.02	75.03
1,024 × 768 @85 Hz	68.68	85.00
1,280 × 1,024 @60 Hz	63.98	60.02
1,280 × 768 @60 Hz	47.70	60.00
1,366 × 768 @60 Hz	48.39	60.04
Macintosh13" (640 × 480)	35.00	66.67
Macintosh16" (832 × 624)	49.73	74.55
Macintosh21" (1,152 × 870)	68.68	75.06

PC (from HDMI terminal)

Applicable input signal for PC is basically compatible to HDMI standard timing.

Signal name	Horizontal frequency (kHz)	Vertical frequency (Hz)
640 × 480 @60 Hz	31.47	60.00
750 (720) / 60p	45.00	60.00
1,125 (1,080) / 60p	67.50	60.00

Note

- Signals other than above may not be displayed properly.
- The above signals are reformatted for optimal viewing on your display.
- PC signal is magnified or compressed for display, so that it may not be possible to show fine detail with sufficient clarity.

Media Player

SD Card

Card format : SDXC Card - exFAT

SDHC Card / SD Card - FAT16 or FAT32

Compliant card type (maximum capacity) : SDXC Card (64 GB), SDHC Card (32 GB), SD Card (2 GB), miniSD Card (2 GB) (requiring miniSD adaptor)

- If miniSD Card is used, insert / remove it together with the adaptor.
- Check the latest information on the card type at the following website.
(English only)
<http://panasonic.jp/support/global/cs/tv/>
- Use an SD Card which meets SD standards. If not, it may cause the TV to malfunction.
- Do not remove the card while the TV is accessing data (this can damage the card or TV).
- Do not touch the pins on the back of the card.
- Do not subject the card to high pressure or impact.
- Insert the card in the correct direction (otherwise, card may be damaged).
- Electrical interference, static electricity, or erroneous operation may damage the data or card.
- Back up the recorded data at regular intervals in case of deteriorated or damaged data or erratic operation of the TV. (Panasonic is not liable for any deterioration or damage of recorded data.)

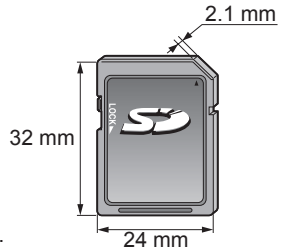

USB Flash Memory

Format : FAT16, FAT32 or exFAT

On screen messages

Message	Meaning / Action
Cannot read file	<ul style="list-style-type: none"> • The file is broken or unreadable. • The TV does not support the format.
No Device Inserted	<ul style="list-style-type: none"> • Confirm SD Card or USB device is inserted correctly.
No valid file to play	<ul style="list-style-type: none"> • The card has no data.
This operation is not possible	<ul style="list-style-type: none"> • Your operation is not available.

Supported file format in Media Player / DLNA

■ Photo

Format	File extension	Image resolution (pixel)	Details / Restrictions
JPEG	.jpg	8 × 8 to 30,719 × 17,279	DCF*1 and EXIF*2 standards Sub-sampling : 4:4:4, 4:2:2, 4:2:0 • Progressive JPEG is not supported.

*1 : Design rule for Camera File system - unified standard established by Japan Electronics and Information Technology Industries Association (JEITA)

*2 : Exchangeable Image File - image file format used by digital cameras

■ Video

Container	File extension	Video codec	Audio codec	Details / Restrictions
SD-Video	.mod	MPEG1 MPEG2	MPEG Dolby Digital	SD-Video Standard Ver. 1.3 (Entertainment Video Profile) • The data may not be available if a folder structure on the current device is modified.
AVCHD	.mts	H.264	Dolby Digital	AVCHD Standard • The data may not be available if a folder structure on the current device is modified.
AVI	.avi .divx	DIV3 DIV4 DIVX DX50 DIV6 XviD MPEG4 SP/ASP	MP3 Dolby Digital MPEG	DivX video file → “DivX” (p. 65) DivX Certified® to play DivX® video up to HD 1080p, including premium content.
MKV	.mkv	H.264 BP/MP/HP	MP3 Dolby Digital MPEG AAC	• MKV's with DTS sound is not supported.
ASF	.asf .wmv	Windows Media Video v9 VC-1	WMA	• Copy-protected files cannot be played back. • WMA Pro and WMA Lossless are not supported.
MP4	.mp4	H.264 BP/MP/HP	MP3 Dolby Digital AAC	–
MOV	.mov	MotionJPEG H.264 BP/MP/HP	RAW TWOS SOWT MP3 Dolby Digital LPCM AAC	• This TV supports Motion JPEG recorded by Panasonic LUMIX Camera. • Some files may not be played back depending on these recording condition. • Motion JPEG can be played back only in Media Player.
TS	.ts .tp	MPEG2 H.264	Dolby Digital AAC MP3	• This container can be played back only in DLNA feature.

■ Music

Codec	File extension	Restrictions
MP3	.mp3	–
AAC	.m4a	• Copy-protected files cannot be played back.
WMA	.wma	• Copy-protected files cannot be played back. • WMA Pro and WMA Lossless are not supported.

Note

- The above table is generalised in nature. Due to file encoding variances, some media files that play on other devices, may not play on the TV even though they fulfill the generalised conditions.
- Do not use two-byte characters or other special codes for data.
- The card may become unusable with this TV if the file or folder names are changed.

DivX Certified® to play DivX® video up to HD 1080p, including premium content.

ABOUT DIVX VIDEO:

DivX® is a digital video format created by DivX, Inc. This is an official DivX Certified® device that plays DivX video.

Visit www.divx.com for more information and software tools to convert your files into DivX video.

Subtitle text file of DivX

Subtitles format - MicroDVD, SubRip, TMLayer

- The DivX video file and subtitles text file are inside the same folder, and the file names are the same except for the file extensions.
- If there are more than one subtitles text files inside the same folder, they are displayed in the following order of priority: “.srt”, “.sub”, “.txt”.
- To confirm or change the current subtitle status while playing DivX content, press the OPTION button to display Option Menu.
- Depending on the methods used to create the file or the state of recording, only parts of the subtitles may be displayed, or the subtitles may not be displayed at all.
- Some subtitles text may not be displayed correctly.

Note

- Depending on how you make SD Card or USB Flash Memory, files and folders may not be displayed in the order you numbered.
- Depending on how you create the files and the structure of folders, the files and folders may not be displayed.
- When there are many files and folders, operation may take time to complete or some files may not be displayed or playable.

ABOUT DIVX VIDEO-ON-DEMAND:

This DivX Certified® device must be registered in order to play purchased DivX Video-on-Demand (VOD) movies. To obtain your registration code, locate the DivX VOD section in your device setup menu. Go to vod.divx.com for more information on how to complete your registration.

To show DivX VOD registration code

➔ [DivX® VOD] in the Setup Menu (p. 27)

- If you want to generate the new registration code, you have to deregister the present registration code. After playing DivX VOD content once, the confirmation screen to deregister will be displayed in [DivX® VOD] in the Setup Menu. If you press the OK button on the confirmation screen, the deregistration code will be generated and you will not be able to play any contents that you purchased using the present registration code.
- You will obtain the new registration code by pressing the OK button on the deregistration code screen.
- If you purchase DivX VOD content using a registration code different from this TV's code, you will not be able to play this content. ([Your device is not authorized to play this DivX protected video.] is displayed.)

Regarding DivX content that can only be played a set number of times

Some DivX VOD content can only be played a set number of times.

When you play this content, the remaining number of plays is displayed. You cannot play this content when the number of remaining plays is zero. ([This DivX rental has expired.] is displayed.)

- When playing this content, the number of remaining plays is reduced by one in the following conditions:
 - If you exit the current application.
 - If you play the other content.
 - If you go to the next or previous content.

Network

On screen messages

Message	Meaning / Action
An internal error occurred.	• Check the settings. ➔ (p. 44 - 46)
Cannot read file	• The file is broken or unreadable. Check applicable data format. ➔ (p. 63 - 64)
Communication with the server failed.	• This might be a problem of the media server. Read the manual of the server software.
Connection to the server failed.	• Check the connections and settings. ➔ (p. 43 - 46)
Server not found	• There is no available media server on your home network. Check the connections and settings. ➔ (p. 43 - 46)
The software update is not completed.	• Network download failed. Check the connections and settings. ➔ (p. 43 - 46)

USB connection

- It is recommended to connect the USB Flash Memory directly to the TV's USB ports.
- Some USB devices or USB HUB may not be used with this TV.
- You cannot connect any devices by using USB card reader.

The combination of USB devices that have been tested for each TV's USB port

Combination of USB port 1 + port 2 (and vice versa):

- USB Flash Memory + Wireless LAN Adaptor
- USB Flash Memory + USB Keyboard
- Wireless LAN Adaptor + USB Keyboard

Note

- Additional information for USB devices may be on the following web site. (English only)
<http://panasonic.jp/support/global/cs/tv/>

Maintenance

First, remove the mains plug from the socket outlet.

Display panel, Cabinet, Pedestal

For regular care:

Gently wipe the surface of the display panel, cabinet, or pedestal by using a soft cloth to clean the dirt or fingerprints.

For stubborn dirt:

Dampen a soft cloth with clean water or diluted neutral detergent (1 part detergent to 100 parts water). Then wring the cloth and wipe the surface. Finally, wipe away all the moisture.

Caution

- Do not use a hard cloth or rub the surface too hard. This may cause scratches on the surface.
- Take care not to subject the TV's surfaces to water or detergent. Liquid inside the TV could lead to product failure.
- Take care not to subject the surfaces to insect repellent, solvent, thinner, or other volatile substances. This may degrade surface quality or cause peeling of the paint.
- The surface of the display panel is specially treated and may be easily damaged. Take care not to tap or scratch the surface with your fingernail or other hard objects.
- Do not allow the cabinet and pedestal to make contact with a rubber or PVC substance for a long time. This may degrade surface quality.

Mains plug

Wipe the mains plug with a dry cloth at regular intervals. Moisture and dust may lead to fire or electrical shock.

FAQs

Before requesting service or assistance, please follow these simple guides to resolve the problem. If the problem still persists, please contact your local Panasonic dealer for assistance.

White spots or shadow images (noise)



- Check the position, direction, and connection of the aerial.

Neither image nor sound is produced

- Is the TV in "AV mode"?
- Is the mains lead plugged into the socket outlet?
- Is the TV turned On?
- Check the Picture Menu (p. 22 - 23) and volume.
- Check all required cables and connections are firmly in place.

An error message appears

- Follow the message's instructions.
- If the problem persists, contact your local Panasonic dealer.

"VIERA Link" function does not work and an error message appears

- Confirm the connection. (p. 51)
- Turn the connected equipment on and then switch the TV on. (p. 52)



Permanently lit spots on screen

- Due to production process involved in this technology this may result in some pixels which are permanently lit or unlit. This is not a malfunction.

Contrast is reduced

- Contrast is lowered in the following conditions without any user operation for a few minutes:
 - no signal in AV mode
 - selected locked channel
 - selected invalid channel
 - displayed menu
 - Thumbnail or still picture

Problem		Actions
Screen	Chaotic image, noisy	<ul style="list-style-type: none"> • Change the setting of [P-NR] in the Picture Menu (to remove noise). ➔ (p. 22) • Check nearby electrical products (car, motorcycle, fluorescent lamp).
	No image can be displayed	<ul style="list-style-type: none"> • Is [Colour] or [Contrast] in the Picture Menu set to the minimum? ➔ (p. 22)
	Blurry or distorted image (no sound or low volume)	<ul style="list-style-type: none"> • Reset channels ➔ (p. 29)
	Unusual image is displayed	<ul style="list-style-type: none"> • Turn the TV Off with Mains power On / Off switch, then turn it On again.
	[Shop] appears on screen at switch on	<ul style="list-style-type: none"> • [Shop] was selected in [Auto Tuning] (p. 12) Reset settings in [Shipping Condition] (p. 32), then select [Home] in [Auto Tuning] ➔ (p. 12)
Sound	No sound is produced	<ul style="list-style-type: none"> • Is "Sound Mute" active? ➔ (p. 11) • Is the volume set to the minimum?
	Sound level is low or sound is distorted	<ul style="list-style-type: none"> • Sound signal reception may be deteriorated. • Set [MPX] in the Sound Menu to [Mono] ➔ (p. 25)
	Unusual sound from the TV	<ul style="list-style-type: none"> • When power is on, drive noise may be heard from inside the TV (not a sign of faulty operation).

	Problem	Actions
HDMI	Sound is unusual	<ul style="list-style-type: none"> • Set the sound setting of the connected equipment to “2ch L.PCM”. • Check the [HDMI1 / 2 / 3 Input] setting in the Sound Menu. ➔ (p. 25) • If digital sound connection has a problem, select analogue sound connection. ➔ (p. 61)
	Pictures from external equipment are unusual when the equipment is connected via HDMI	<ul style="list-style-type: none"> • Check the HDMI cable is connected properly. ➔ (p. 51, 56 - 58) • Turn the TV and equipment Off, then turn them On again. • Check an input signal from the equipment. ➔ (p. 62) • Use equipment compliant with EIA/CEA-861/861D.
Network	Cannot connect to the network	<ul style="list-style-type: none"> • Check the LAN cable or Wireless LAN Adaptor is connected properly. ➔ (p. 43) • Check the connections and settings. ➔ (p. 43 - 46) • Check the network equipment and network environment. • If the problem persists, consult your Internet Service Provider or telecommunications company.
	Cannot select the file during DLNA operations	<ul style="list-style-type: none"> • Is the media server prepared? ➔ (p. 42) • Check applicable data format. ➔ (p. 63 - 64)
	Cannot access the Internet contents	<ul style="list-style-type: none"> • Check the connections and settings. ➔ (p. 43 - 46) • The server or connected line might be busy now.
Other	The TV goes into Standby mode	<ul style="list-style-type: none"> • Auto power standby function is activated. • The TV enters Standby mode about 30 minutes after analogue broadcasting ends.
	The remote control does not work or is intermittent	<ul style="list-style-type: none"> • Are the batteries installed correctly? ➔ (p. 6) • Has the TV been switched On? • Point the remote control directly at the front of the TV (within about 7 m and a 30 degree angle of the front of the TV). • Situate the TV away from sunshine or other sources of bright light not to shine on the TV's remote control signal receiver.
	Parts of the TV become hot	<ul style="list-style-type: none"> • Even when the temperature of parts of the front, top and rear panels has risen, these temperature rises will not pose any problems in terms of performance or quality.

Specifications

		TH-P42X30D TH-P42X30K TH-P42X30M TH-P42X30Q TH-P42X30T TH-P42X30V	TH-P42X30P	TH-P50X30D TH-P50X30K TH-P50X30M TH-P50X30Q TH-P50X30T TH-P50X30V	TH-P50X30P	
Power Source		AC 220 - 240 V, 50 / 60 Hz	AC 110 - 240 V, 50 / 60 Hz	AC 220 - 240 V, 50 / 60 Hz	AC 110 - 240 V, 50 / 60 Hz	
Power	Power Rating	200 W	205 W	250 W	255 W	
	Standby condition	0.4 W	0.4 W	0.4 W	0.4 W	
Display panel	Aspect Ratio	16:9				
	Visible screen size	106 cm (diagonal) 921 mm (W) × 518 mm (H)		127 cm (diagonal) 1,105 mm (W) × 622 mm (H)		
	Number of pixels	786,432 (1,024 (W) × 768 (H)) [3,072 × 768 dots]				
Sound	Speaker	160 mm × 40 mm × 2, 6 Ω				
	Audio Output	20 W (10 W + 10 W)				
	Headphones	M3 (3.5 mm) stereo mini Jack × 1				
PC signals		VGA, SVGA, WVGA, XGA SXGA, WXGA (compressed) Horizontal scanning frequency 31 - 69 kHz Vertical scanning frequency 59 - 86 Hz				
Receiving Systems / Band name		17 Systems		Function		
		1	PAL B, G, H	Reception of broadcast transmissions and Playback from Video Cassette Tape Recorders	8	NTSC 4.43/5.5 MHz
		2	PAL I		9	NTSC 4.43/6.0 MHz
		3	PAL D, K		10	NTSC 4.43/6.5 MHz
		4	SECAM B, G		11	NTSC 3.58/5.5 MHz
		5	SECAM D, K		12	NTSC 3.58/6.0 MHz
		6	SECAM K1		13	NTSC 3.58/6.5 MHz
		7	SECAM M (NTSC 3.58/4.5 MHz)		14	SECAM I
		15	PAL 60 Hz/5.5 MHz	Playback from Special Disc Players and Special VCR's or DVD		
		16	PAL 60 Hz/6.0 MHz	Playback from Special Disc Players and Special VCR's or DVD		
		17	PAL 60 Hz/6.5 MHz			
Receiving Channels (Analogue TV)		VHF BAND 2-12 (PAL/SECAM B, K1) 0-12 (PAL B AUST.) 1-9 (PAL B N.Z.) 1-12 (PAL/SECAM D) 1-12 (NTSC M Japan) 2-13 (NTSC M USA)	UHF BAND 21-69 (PAL G, H, I/SECAM G, K, K1) 28-69 (PAL B AUST.) 13-57 (PAL D, K) 13-62 (NTSC M Japan) 14-69 (NTSC M USA)	CATV S1-S20 (OSCAR) 1-125 (USA CATV) C13-C49 (JAPAN) S21-S41 (HYPER) Z1-Z37 (CHINA) 5A, 9A (AUST.)		
Aerial - Rear		VHF / UHF				
Operating Conditions		Temperature : 0 °C - 40 °C Humidity : 20 % - 80 % RH (non-condensing)				
Connection Terminals	AV1 Input	AUDIO L - R	RCA PIN Type × 2	0.5 V[rms]		
		VIDEO	RCA PIN Type × 1	1.0 V[p-p] (75 Ω)		
		COMPONENT	Y P _B /C _B , P _R /C _R	1.0 V[p-p] (including synchronisation) ±0.35 V[p-p]		
	AV2 Input	AUDIO L - R	RCA PIN Type × 2	0.5 V[rms]		
		VIDEO	RCA PIN Type × 1	1.0 V[p-p] (75 Ω)		
	AV3 Input	AUDIO L - R	RCA PIN Type × 2	0.5 V[rms]		
		VIDEO	RCA PIN Type × 1	1.0 V[p-p] (75 Ω)		
	Audio Output	AUDIO L - R	RCA PIN Type × 2	0.5 V[rms] (high impedance)		
	Others	HDMI1 - 3 Input	TYPE A Connectors		• This TV supports "HDAVI control 5" function.	
		PC Input	HIGH-DENSITY D-SUB 15PIN	R / G / B : 0.7 V[p-p] (75 Ω) HD / VD : TTL Level 2.0 - 5.0 V[p-p] (high impedance)		
DIGITAL AUDIO OUT		PCM / Dolby Digital, Fiber optic				
Card slot		SD Card slot × 1				
USB 1/2		USB 2.0 TYPE A Connectors		DC 5 V, Max. 500 mA		
	ETHERNET	10BASE-T / 100BASE-TX				
Dimensions (W × H × D)		1,023 mm × 671 mm × 288 mm (With Pedestal) 1,023 mm × 637 mm × 93 mm (TV only)		1,212 mm × 782 mm × 324 mm (With Pedestal) 1,212 mm × 747 mm × 93 mm (TV only)		
Mass		26.5 kg Net (With Pedestal) 23.5 kg Net (TV only)		34.0 kg Net (With Pedestal) 30.5 kg Net (TV only)		

Note

- Design and Specifications are subject to change without notice. Mass and Dimensions shown are approximate.

Information on Disposal in other Countries outside the European Union



This symbol is only valid in the European Union.
If you wish to discard this product, please contact your local authorities or dealer and ask for the correct method of disposal.